

EN - english

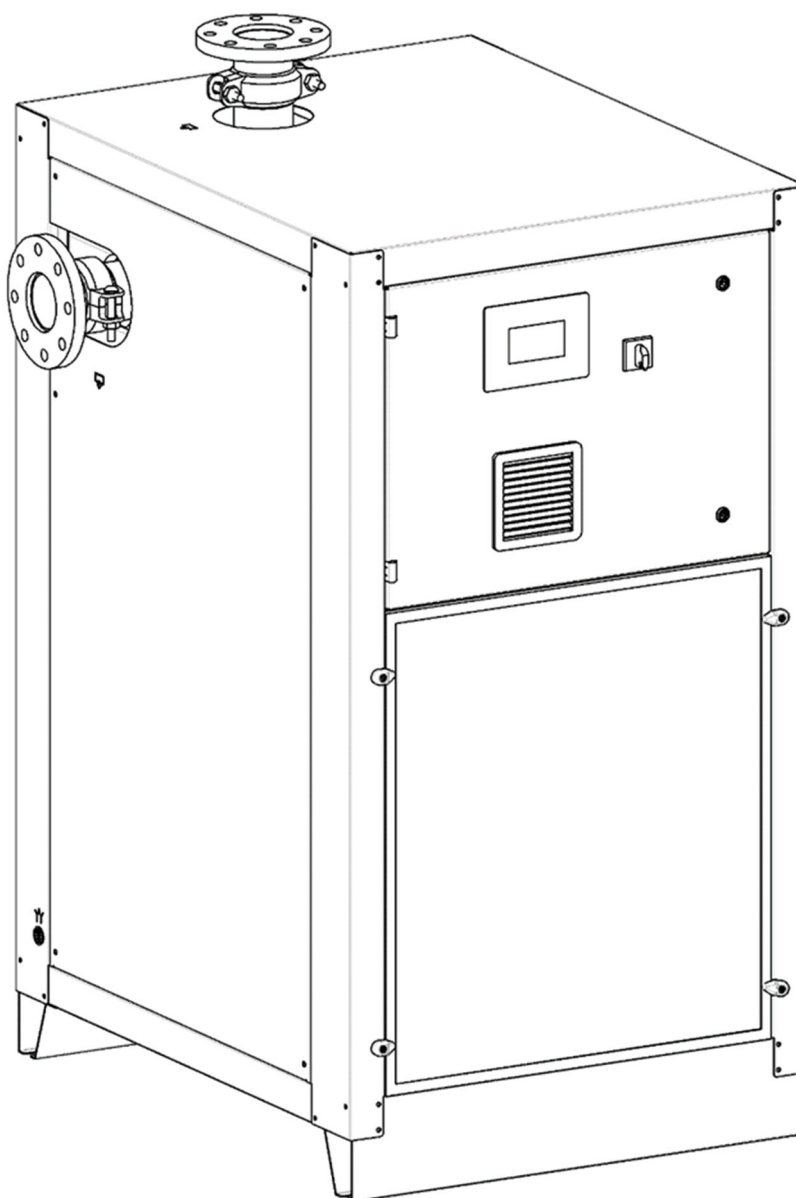

Instructions for installation and operation

Compressed air refrigeration dryer DRYPOINT® RA 1300-4400 eco





05-408
00_00

Dear customer,

Thank you for deciding in favour of the DRYPOINT® RA 1300-4400 eco compressed-air refrigeration dryer. Please read these installation and operating instructions carefully before mounting and starting up the DRYPOINT® RA 1300-4400 eco and follow our directions. Perfect functioning of the DRYPOINT® RA 1300-4400 eco and thus reliable compressed-air drying can only be guaranteed when the provisions and notes stipulated here are strictly adhered to.

Contents

1	Name plate	5
2	Safety instructions	5
2.1	Safety pictograms in accordance with DIN 4844	6
2.2	Signal words in accordance with ANSI	8
2.3	Overview of the safety instructions	8
3	Proper use	10
4	Exclusion from a field of application	11
5	Operating instructions in accordance with the 2014/68/EU Pressure Equipment Directive	11
6	Transport	12
7	Storage	12
8	Installation	13
8.1	Place of installation	13
8.2	Installation plan	14
8.3	Correction factors	15
8.4	Connection to the compressed-air system	16
8.4.1	Inlet / outlet flanged air connections (only RA 1300 – 2200 eco)	16
8.5	Connection to the cooling-water network	17
8.6	Minimum cooling-water requirements:	18
8.7	Electrical connections	19
8.8	Condensate drain	20
9	Start-up	20
9.1	Preliminary stages	20
9.2	Initial start-up	21
9.3	Start-up and shut down	22
10	Technical data	23
10.1	Technical data DRYPOINT RA 1300-4400 eco 3/400/50	23
10.2	Technical data DRYPOINT RA 1300-4400 eco 3/460/60	24
11	Technical description	25
11.1	Control panel	25
11.2	Functional description	25
11.3	Flow chart (air-cooled)	26
11.4	Flow chart (water-cooled)	26
11.5	Refrigerating compressor	27
11.6	Condenser (air-cooled)	27
11.7	Condenser (water-cooled)	27
11.8	Cooling-water regulating valve	27
11.9	Filter dryer	27
11.10	Electronic Expansion Valve (EEV)	27
11.11	Alu-Dry module	28
11.12	Refrigerant pressure switches LPS – HPS	28
11.13	Compressor crankcase heater	28
11.14	Electrical panel fan	28
11.15	DMC50 electronic control unit	29
11.15.1	Starting the dryer (“ON” mode)	29
11.15.2	Stopping the dryer (“STANDBY” mode)	29
11.15.3	Performing the condensation drain test	29
11.15.4	Displaying process values T1, T2, T3, T4, HP, LP, %  , % 	30
11.15.5	How the DMC50 control unit displays and processes a service warning	31
11.15.6	How the DMC50 control unit displays and processes an alarm	32
11.15.7	Displaying the log file of stored alarms	34
11.15.8	Downloading the process values stored following an alarm	35
11.15.9	Displaying instantaneous process values for the compressor inverter	35
11.15.10	Displaying technical maintenance and energy savings data	36
11.15.11	Controlling the dryer from a remote workstation	37
11.15.12	How the alarm / service warning flagging contact operates	37
11.15.13	How the RS485 serial communication port operates	37
11.15.14	Displaying / changing process user parameters	38

11.15.15	Changing the system date / time	40
11.15.16	Changing the user interface language	40
11.16	Electronically level-controlled BEKOMAT condensate drain	41
12	Maintenance, troubleshooting, spare parts and dismantling	42
12.1	Checks and maintenance	42
12.2	Troubleshooting	43
12.3	Recommended spare parts	52
12.4	Maintenance works at the refrigeration cycle	53
12.5	Dismantling the dryer	53
13	Attachments	54
	Exploded views – List of components	54
	Electric diagrams – List of components	54
13.1	Dryers dimensions	55
13.1.1	DRYPOINT RA 1300-2200 eco	55
13.1.2	DRYPOINT RA 2400-4400 eco	56
13.2	Exploded views	57
13.2.1	DRYPOINT RA 1300-2200 eco Air-cooled	57
13.2.2	DRYPOINT RA 1300-2200 eco Water-cooled	58
13.2.3	DRYPOINT RA 2400-4400 eco Air-cooled	59
13.2.4	DRYPOINT RA 2400-4400 eco Water-cooled	60
13.3	Electric diagrams	61
13.3.1	DRYPOINT RA 1300-2200 eco	61
13.3.2	DRYPOINT RA 2400-2900 eco	67
13.3.3	DRYPOINT RA 3600-4400 eco	74
14	EC declaration of conformity	81

1 Name plate

The name plate is on the back of the dryer and comprises all primary data of the device. Always refer to these data when contacting the manufacturer or the sales department.

All guarantee claims will expire in the event that the name plate is modified or removed.

The dryer model printed on the nameplate includes one or more suffixes that specify one or more features of dryer.

Explanation of 1st suffix for power supply requirements :

1st SUFFIX	DESCRIPTION OF FEATURE
none	3/400/50
-R	3/460/60

Explanation of 2nd suffix for cooling requirements :

2nd SUFFIX	DESCRIPTION OF FEATURE
/ AC	Air cooled
/ WC	Fresh water cooled
/ SWC	Sea water cooled, tube bundle condenser
/ TBH	Fresh water cooled, tube bundle condenser

Explanation of (eventual) 3rd suffix for special feature :

3rd SUFFIX	DESCRIPTION OF FEATURE
-TAC	Anti corrosion treatment
-SP	Special feature
-OF	Dryer oil free

Examples : DP RA2200-R /AC eco → DRYPOINT RA2200 eco, 3/460/60, Air cooled

DP RA1800 /SWC eco → DRYPOINT RA1800 eco, 3/400/50, Sea water cooled, tube bundle cond.

2 Safety instructions



Please check whether or not these instructions correspond to the device type.

Please adhere to all advice given in these operating instructions. They include essential information which must be observed during installation, operation and maintenance. Therefore, it must be ensured that these operating instructions are read by the fitter and the responsible operator / certified skilled personnel prior to installation, start-up and maintenance.

The operating instructions must be accessible at all times at the place of application of the DRYPOINT® RA 1300-4400 eco compressed-air refrigeration dryer.

In addition to these operating instructions, local and national regulations need to be observed, where required.

Ensure that operation of the DRYPOINT® RA 1300-4400 eco compressed-air refrigeration dryer only takes place within the permissible limit values indicated on the name plate. Any deviation from these limit values involves a risk for persons and for the material, and may result in malfunction or a breakdown.

After installing the device correctly and in accordance with the instructions in this manual, the dryer is ready to operate, further settings are not required. Operation is fully automatic and maintenance is limited to several examinations and cleaning measures which are described in the following chapters.

This manual must be available at all times for future reference and is a constituent part of the dryer.

If you have any queries regarding these installation and operating instructions, please contact BEKO TECHNOLOGIES GMBH.

2.1 Safety pictograms in accordance with DIN 4844



Observe operating instructions



General danger symbol



Supply voltage



Danger: component or system under pressure



Hot surfaces



Non-breathable air



Do not use water to extinguish the fire



Do not operate with open cover (housing)



Maintenance works or controlling measures must only be carried out by qualified personnel ¹



Do not smoke



Note



Connection point compressed-air inlet



Connection point compressed-air outlet



Connection point condensate drain



Connection point cooling-water inlet (water-cooled)

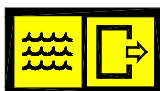

Connection point cooling-water outlet (water-cooled)

¹ Certified skilled personnel are persons who are authorised by the manufacturer, with experience and technical training, who are well-grounded in the respective provisions and laws and capable of carrying out the required works and of identifying and avoiding any risks during the machine transport, installation, operation and maintenance. Qualified and authorised operators are persons who are instructed by the manufacturer regarding the handling of the refrigeration system, with experience and technical training, and who are well-grounded in the respective provisions and laws.



Works can be carried out by the operator of the plant, provided that they are skilled accordingly ².

NOTE: Text that contains important specifications to be considered – does not refer to safety precautions.



The device was carefully designed with particular attention paid to environmental protection:

- CFC-free refrigerants
- CFC-free insulation material
- Energy-saving design
- Limited acoustic emissions
- Dryer and packaging comprise reusable materials

This symbol advises the user to observe the environmental aspects and comply with the recommendations connected with this symbol.

² Certified skilled personnel are persons who are authorised by the manufacturer, with experience and technical training, who are well-grounded in the respective provisions and laws and capable of carrying out the required works and of identifying and avoiding any risks during the machine transport, installation, operation and maintenance. Qualified and authorised operators are persons who are instructed by the manufacturer regarding the handling of the refrigeration system, with experience and technical training, and who are well-grounded in the respective provisions and laws.

2.2 Signal words in accordance with ANSI

Danger!	Imminent hazard Consequences of non-observance: serious injury or death
Warning!	Potential hazard Consequences of non-observance: possible serious injury or death
Caution!	Imminent hazard Consequences of non-observance: possible injury or property damage
Notice!	Potential hazard Consequences of non-observance: possible injury or property damage
Important!	Additional advice, info, hints Consequences of non-observance: disadvantages during operation and maintenance, no danger

2.3 Overview of the safety instructions



Certified skilled personnel

Installation works must exclusively be carried out by authorised and qualified skilled personnel. Prior to undertaking any measures on the DRYPOINT® RA 1300-4400 eco compressed-air refrigeration dryer, the certified skilled personnel shall read up on the device by carefully studying the operating instructions. The operator is responsible for the adherence to these provisions. The respective directives in force apply to the qualification and expertise of the certified skilled personnel. For safe operation, the device must only be installed and operated in accordance with the indications in the operating instructions. In addition, the national and operational statutory provisions and safety regulations, as well as the accident prevention regulations required for the respective case of application, need to be observed during employment. This applies accordingly when accessories are used.



Danger!

Compressed air!

Risk of serious injury or death through contact with quickly or suddenly escaping compressed air or through bursting and/or unsecured plant components.

Compressed air is a highly dangerous energy source.

Never work on the dryer when the system is under pressure.

Never direct the compressed-air outlet or condensate drain hoses at persons.

The user is responsible for the proper installation of the dryer. Non-observance of the instructions in the "Installation" chapter leads to the expiration of the guarantee. Improper installation may result in dangerous situations for the personnel and/or the device.



Danger!

Supply voltage!

Contact with non-insulated parts carrying supply voltage involves the risk of an electric shock resulting in injuries and death.

Only qualified and skilled personnel are authorised to run electrically-operated devices. Prior to undertaking maintenance measures at the device, the following requirements must be met:

Make sure that the power supply is switched off and that the device is off and marked for maintenance measures. Please also ensure that the power supply cannot be re-established during the works.



Prior to carrying out maintenance works at the dryer, switch it off main switch (control panel pos.1) and wait for at least 30 minutes.



Caution!

Refrigerant!

The compressed-air refrigeration dryer uses HFC-containing refrigerants as a coolant.

Please observe the corresponding paragraph entitled "Maintenance works at the refrigeration cycle".



Warning!

Refrigerant leak!

A refrigerant leak involves the danger of serious injury and damage to the environment.



The DRYPOINT® RA 1300-4400 eco compressed-air refrigeration dryer contains fluorinated greenhouse gas/refrigerant.

Installation, repair and maintenance works at the refrigeration system must only be carried out by certified skilled personnel (specialists). A certification in accordance with EC regulation 303/2008 must be available.



The requirements of the EC 842/2006 directive must be met under all circumstances.

Please refer to the indications on the name plate as regards the type and amount of refrigerant.



Comply with the following protective measures and rules of conduct:



1. **Storage:** Keep the container tightly closed. Keep it in a cool and dry place. Protect it against heat and direct sunlight. Keep it away from ignition sources.
2. **Handling:** Take measures against electrostatic charging. Ensure good ventilation/suction at the workplace. Check fittings, connections and ducts for tightness. Do not inhale the gas. Avoid contact with the eyes or the skin.
3. Prior to carrying out works on refrigerant-carrying parts, remove the refrigerant to such an extent that safe working is possible.
4. Do not eat, drink or smoke during work. Keep out of the reach of children.
5. **Breathing protection:** ambient-air-independent respirator (at high concentrations).
6. **Eye protection:** sealing goggles.
7. **Hand protection:** protective gloves (e.g. made of leather).
8. **Personal protection:** protective clothing.
9. **Skin protection:** use protective cream.

In addition, the safety data sheet for the refrigerant needs to be observed!



Caution!

Hot surfaces!

During operation, several components can reach surface temperatures of more than +60°C. There is the risk of burns.

All components concerned are installed inside of the closed housing. The housing must only be opened by certified skilled personnel³.



Caution!

Improper use!



The device is intended for the separation of water in compressed air. The dried compressed air cannot be used for breathing-air purposes and is not suitable for the direct contact with food.

This dryer is not suitable for the treatment of contaminated air or of air containing solids.

³ Certified skilled personnel are persons who are authorised by the manufacturer, with experience and technical training, who are well-grounded in the respective provisions and laws and capable of carrying out the required works and of identifying and avoiding any risks during the machine transport, installation, operation and maintenance. Qualified and authorised operators are persons who are instructed by the manufacturer regarding the handling of the refrigeration system, with experience and technical training, and who are well-grounded in the respective provisions and laws.



Note!

Contaminated intake air!

In normal condition (comply with ISO 8573.1 class 2.-3) we recommend the installation of C-Filters (e. g. CLEARPOINT S040CWT) upstream to the dryer.

In case the intake air is strongly contaminated (ISO 8573.1 class 5.-4 or poorer quality), we recommend the installation of a fine filter (e.g. CLEARPOINT S040FWT) in order to guarantee an optimal thermal transfer in the heat exchanger. Strongly contaminated compressed air leads to the concentration of oil, creating an oil layer that interrupts the thermal transfer and could clog the heat exchanger / filter.



Caution!

Heating-up through fire!

In the event of a heating-up through fire, the containers and pipes of the refrigerant system can burst.



In this case, please proceed as follows:

Switch off the refrigeration plant.

Switch off the mechanical ventilation of the machinery compartment.

Use ambient-air-independent respirators.

Containers and plants which are filled with refrigerant can burst violently in the event of fire.

The refrigerants themselves are incombustible, but they are degraded to very toxic products at high temperatures.

Remove the container/plant from the fire zone, as there is the risk of bursting!

Cool down containers and bottles via a directed water jet from a safe position.

In the event of fire, please use an approved fire extinguisher. Water is not a suitable agent to extinguish an electrical fire.

This must only be carried out by persons who are trained and informed about the hazards emanating from the product.



Caution!

Unauthorised intervention!

Unauthorised interventions may endanger persons and plants and lead to malfunction.

Unauthorised interventions, modification and abuse of the pressure devices are prohibited.

The removal of sealings and leadings at safety devices is prohibited.

Operators of the devices must observe the local and national pressure equipment regulations in the country of installation.



Note!

Ambient conditions!

In the event that the dryer is not installed under suitable ambient conditions, the ability of the device to condense refrigerant gas is impaired. This can result in a higher load of the refrigerating compressor, and in a loss of efficiency and performance of the dryer.

This in turn leads to overheated condenser fan motors, to malfunction of electric components and to a breakdown of the dryer. Failures of this type will affect warranty considerations.

Do not install the dryer in an environment in which chemicals with a corrosive effect, explosive gases, toxic gases, evaporation heat, high ambient temperatures or extreme dust and dirt can be found.

3 Proper use

This dryer was designed, manufactured and tested to separate the moisture which normally exists in compressed air. Any other use is considered improper.

The manufacturer shall not be liable for problems occurring as a consequence of improper use. The user alone is responsible for any damage resulting from that.

Furthermore, the correct use includes the compliance with the installation instructions, in particular in respect of:

- The voltage and frequency of the main voltage supply.
- The pressure, temperature and flow rate of the inlet air.
- The pressure, temperature and cooling-water throughput (water-cooled).
- The ambient temperature.

When delivered, the dryer is tested and fully assembled. The customer only needs to connect the device to the system in accordance with the instructions in the following chapters.

4 Exclusion from a field of application



Note! Improper use!



The device is intended for the separation of water in compressed air. The dried compressed air cannot be used for breathing-air purposes and is not suitable for the direct contact with food.

This dryer is not suitable for the treatment of contaminated air or of air containing solids.

5 Operating instructions in accordance with the 2014/68/EU Pressure Equipment Directive

The DRYPOINT® RA 1300-4400 eco compressed-air refrigeration dryer contains pressure equipment in the sense of the 2014/68/EU Pressure Equipment Directive. Therefore, the entire plant needs to be registered with the supervisory authority if required in accordance with the local regulations.

For the examination prior to the start-up and for periodic inspections, the national regulations need to be observed, such as the industrial safety regulation in the Federal Republic of Germany. In countries outside the EU, the respective regulations in force there need to be adhered to.

The proper use of pressure devices is the basic requirement for safe operation. As regards pressure devices, the following points need to be observed:

- The DRYPOINT® RA 1300-4400 eco compressed-air refrigeration dryer must only be employed within the pressure and temperature range limits indicated by the manufacturer on the name plate.
- No welding must be carried out on the pressure parts.
- The DRYPOINT® RA 1300-4400 eco compressed-air refrigeration dryer must neither be installed in insufficiently ventilated rooms nor near heat sources or inflammable substances.
- To avoid fractures resulting from material fatigue, the refrigeration dryer should not be exposed to vibrations during operation.
- The maximum operating pressure indicated by the manufacturer on the name plate must not be exceeded. It is the installer's responsibility to install the appropriate safety and control devices. Prior to the start-up of the DRYPOINT® RA 1300-4400 eco compressed-air refrigeration dryer, the connected pressure generator (compressor etc.) must be set to the max. permissible operating pressure. The integrated safeguard needs to be checked by an approved inspection agency.
- The documents related to the DRYPOINT® RA 1300-4400 eco compressed-air refrigeration dryer (manual, operating instructions, manufacturer's declaration etc.) must be kept safe for future reference.
- No objects whatsoever must be installed at or placed on the DRYPOINT® RA 1300-4400 eco compressed-air refrigeration dryer and the connecting lines.
- Installation of the plant in frost-free places only.
- Operation of the plant is only permissible with fully closed and intact housing and cover panels. Operation of the plant with damaged housing/cover panels is prohibited.

6 Transport

Check the packaging for visible loss or damage. If no visible damage can be ascertained, place the unit in close proximity to the place of installation and unpack the device.

During this procedure, the dryer must always remain in an upright position. The components may be damaged when the unit is tilted or turned upside down.

Store the device in a dry environment and do not expose it to extreme weather conditions.

Handle with care. Strong shocks can cause irreparable damage.

7 Storage

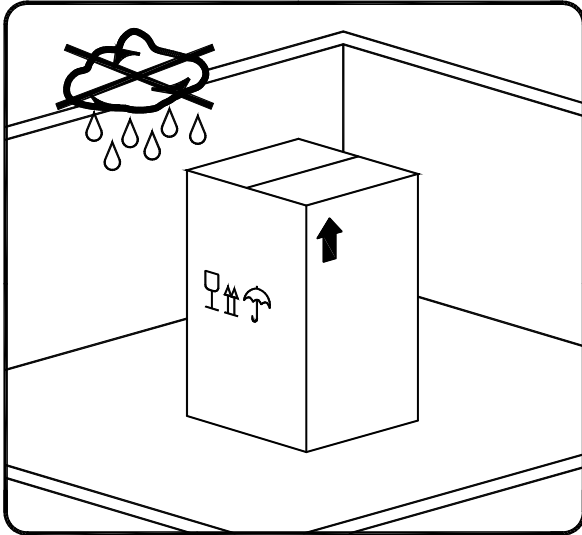

Keep the device away from extreme weather conditions even when packaged.

Keep the dryer in an upright position, also while it is stored. Tilting the device or turning it upside down can cause irreparable damage to some components.

When the dryer is not in use, it can be stored in its packaging in a dust-free and protected place at a temperature of +1°C ... +50° C (34°F...122°F), and at a specific humidity of max. 90%. If the storage period exceeds 12 months, you should contact the manufacturer.



The packaging material is recyclable. Dispose of the material in accordance with the directives and provisions in force in the country of destination

8 Installation

8.1 Place of installation

**Note!****Ambient conditions!**

In the event that the dryer is not installed under suitable ambient conditions, the ability of the device to condense refrigerant gas is impaired. This can result in a higher load of the refrigerating compressor, and in a loss of efficiency and performance of the dryer.

This in turn leads to overheated condenser fan motors, to malfunction of electric components and to a breakdown of the dryer. Failures of this type will affect warranty considerations.

Do not install the dryer in an environment in which chemicals with a corrosive effect, explosive gases, toxic gases, evaporation heat, high ambient temperatures or extreme dust and dirt can be found.

Minimum installation requirements:

- Choose an area which is clean and dry, free from dust and protected against atmospheric disturbances.
- The load-bearing zone must be even, horizontal and able to bear the weight of the dryer.
- Minimum ambient temperature +1°C.
- Maximum ambient temperature +45°C.
- Ensure a proper cooling air replacement.
- Allow a sufficient clearance on each side of the dryer for proper ventilation and to facilitate maintenance operations. The dryer does not require attachment to the floor surface.

**Do not obstruct the ventilation grille (not even partially).**

Prevent any recirculation of the outgoing cooling air.

Protect the dryer against draughts.

8.2 Installation plan

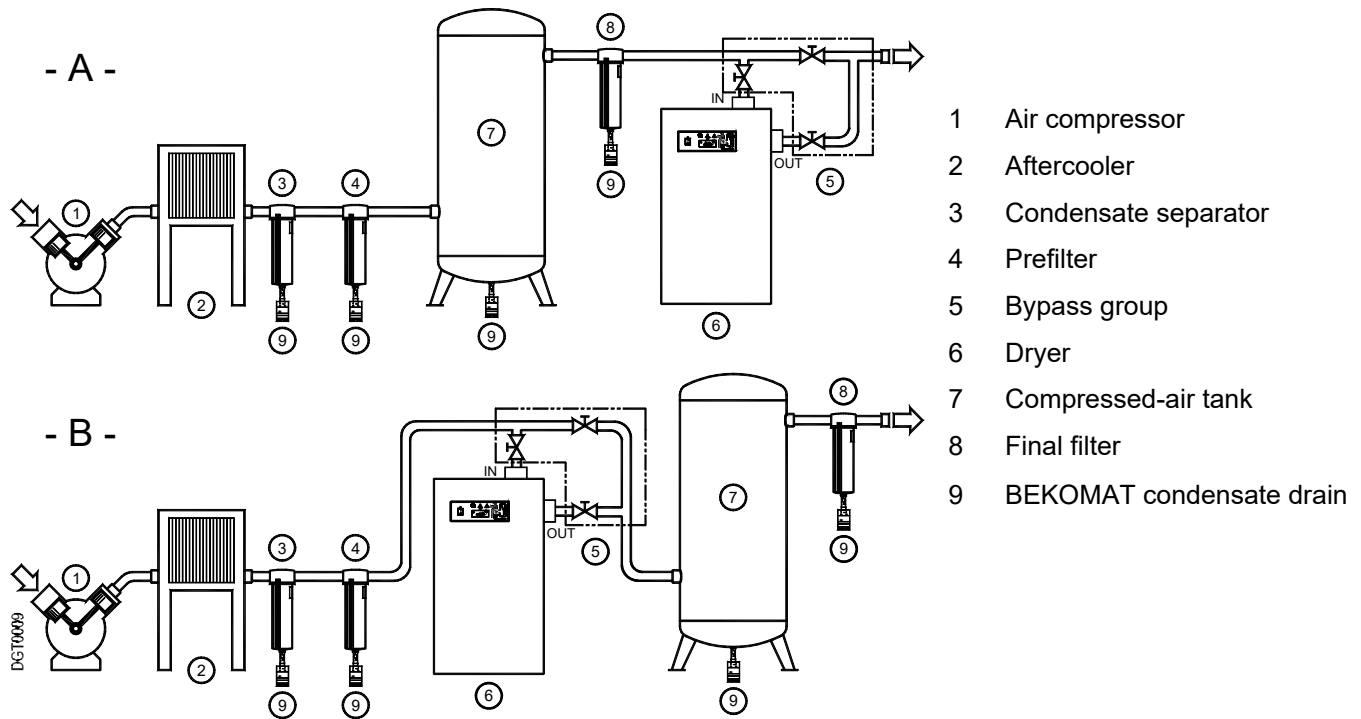

Dryer's compressor and fan (air cooled) speed are adjusted to adapt power consumption to the dryer load. Although system is quite reactive, it cannot adapt its setting immediately to sudden load variation leading to dewpoint spikes/fluctuations.

To avoid this behaviour it is recommended to install the dryer in systems where load variations happens but are damped. Compressed air receivers can be used as dampers : installed before the dryer if compressors capacity varies suddenly and frequently, after the dryer if the air consumption variation is very wide, frequent and sudden or both to have the best load variation dampness.

Compressed air tanks can be installed as capacity dampers: installed before the dryer (Type A) if the compressor capacity varies suddenly and often, after the dryer (Type B) if the change in air consumption is very large, frequent and sudden or both to have the improved dampening of the flow variation.



Do not obstruct the ventilation grille (not even partially).

Prevent any recirculation of the outgoing cooling air.
Protect the dryer against draughts.



Contaminated intake air!

In normal condition (comply with ISO 8573.1 class 2.-3) we recommend the installation of C-Filters (e. g. CLEARPOINT S040CWT) upstream to the dryer.

In case the intake air is strongly contaminated (ISO 8573.1 class 5.-4 or poorer quality), we recommend the installation of a fine filter (e.g. CLEARPOINT S040FWT) in order to guarantee an optimal thermal transfer in the heat exchanger. Strongly contaminated compressed air leads to the concentration of oil, creating an oil layer that interrupts the thermal transfer and could clog the heat exchanger / filter.

8.4 Connection to the compressed-air system



Danger!
Compressed air!

All works must only be carried out by qualified skilled personnel.

Never work on compressed-air systems which are under pressure.

The operator or the user must ensure that the dryer is never operated with a pressure exceeding the maximum pressure value indicated on the name plate.

Exceeding the maximum operating pressure can be dangerous for the operator but also for the device.

The air temperature and the air flow at the inlet of the dryer must lie within the limit values indicated on the name plate. The connecting lines must be free from dust, iron rust, shards and other contaminations and correspond to the flow rate of the dryer. Should air with a very high temperature be treated, the installation of an aftercooler may be necessary. For the implementation of maintenance works, the installation of a bypass system is recommended.

The dryer was designed in such a manner that vibrations that may occur during operation are limited. Therefore, it is advisable to employ connecting lines (flexible hoses, vibration-inhibiting fittings etc.) which protect the dryer against possible vibrations in the pipework.

Note!

Contaminated intake air!

In normal condition (comply with ISO 8573.1 class 2.-3) we recommend the installation of C-Filters (e. g. CLEARPOINT S040CWT) upstream to the dryer.

In case the intake air is strongly contaminated (ISO 8573.1 class 5.-4 or poorer quality), we recommend the installation of a fine filter (e.g. CLEARPOINT S040FWT) in order to guarantee an optimal thermal transfer in the heat exchanger. Strongly contaminated compressed air leads to the concentration of oil, creating an oil layer that interrupts the thermal transfer and could clog the heat exchanger / filter.

8.4.1 Inlet / outlet flanged air connections (only RA 1300 – 2200 eco)

Inlet / outlet flanged air connections and clamp joints are located inside the box under the dryer (see Fig.1).



Assembly flange (B) and clamp joint (A) as shown in Fig.2

Pay particular attention in not damaging the gasket of clamp joint (A).

Fully tighten the two bolts of clamp joint (see Fig.3)

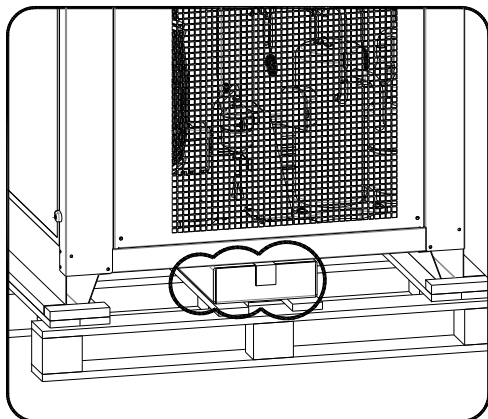

Fig.1

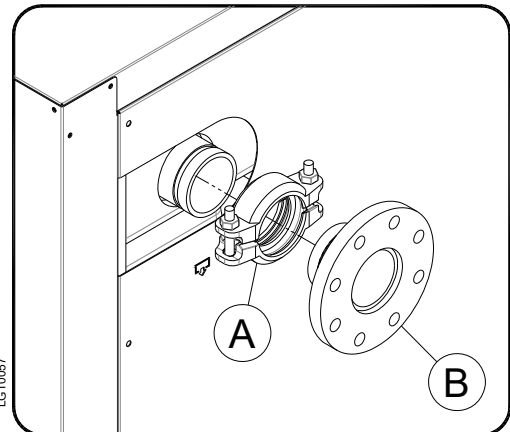

Fig.2

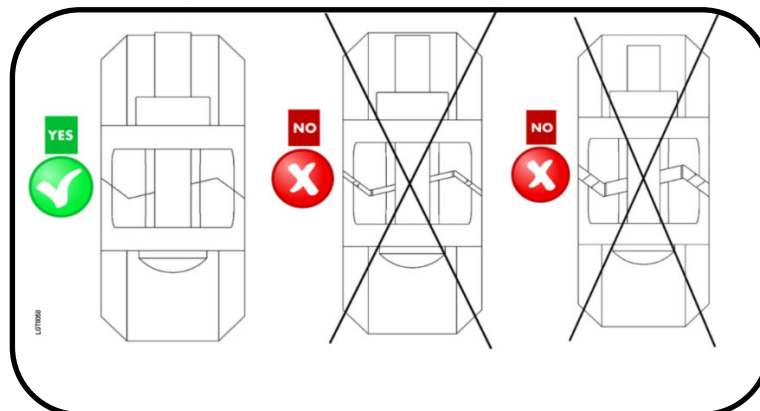

Fig.3

8.5 Connection to the cooling-water network

**Danger!****Compressed air and unqualified personnel!**

All works must only be carried out by qualified skilled personnel.

Never work on compressed-air systems which are under pressure.

The user must ensure that the dryer is never operated with a pressure exceeding the nominal values.

Possible overpressure can be dangerous for the operator but also for the device.



The temperature and the amount of cooling water need to correspond to the limit values indicated on the name plate. The cross-section of the connecting lines, which should preferably be flexible, must be free from dust, iron rust, shards and other contaminations. We recommend employing connecting lines (flexible hoses, vibration-inhibiting fittings etc.) which protect the dryer against possible vibrations in the pipework.

**Note!**

Contaminated intake water!

In the event that the intake water is strongly contaminated we recommend the additional installation of a prefilter (500 micron), to avoid clogging of the heat exchanger.

8.6 Minimum cooling-water requirements:

Copper brazed stainless steel condenser

Temperature	+15°C...+30°C (+59°F...+86°F) *1
Pressure	3...10 barg (43.5...145 psig) *2
Delivery pressure	> 3 bar (43.5 psi) *2 *3
PH	7.5...9.0
Total hardness	6.0... 15 °dH
Conductivity	10...500 µS/cm
Sulphates (SO ₄ ²⁻)	< 100 mg/l or ppm
Hydrogen Carbonate / Sulphates (HCO ₃ / SO ₄ ²⁻)	> 1.0 mg/l or ppm
Ammonia (NH ₃)	< 0.5 mg/l or ppm
Free aggressive carbonic acid	< 20 mg/l or ppm
Ammonium (NH ₄ ⁺)	< 2 mg/l or ppm
Saturation Index SI	-0.2 < 0 < 0.2
Hydrogen carbonate (HCO ₃)	< 300 mg/l or ppm
Residual solid particles	< 30 mg/l or ppm
Chlorides (Cl ⁻)	< 5 mg/l or ppm
Free chlorine (Cl ₂)	< 0.5 mg/l or ppm
Oxygen content	< 0.1 mg/l or ppm
Carbon dioxide (CO ₂)	< 50 mg/l or ppm
Hydrogen sulphide (H ₂ S)	< 0.05 mg/l or ppm
Phosphate (PO ₄ ³⁻)	< 2 mg/l or ppm
Iron (Fe)	< 0.2 mg/l or ppm
Manganese (Mn)	< 0.1 mg/l or ppm
Nitrate (NO ₃ ⁻)	< 100 mg/l or ppm
Nitrite (NO ₂ ⁻)	< 0.1 mg/l or ppm
Sulphide (S ²⁻)	< 1 mg/l or ppm

Tube bundle condenser

Temperature	+15°C...+30°C (+59°F...+86°F) *1
Pressure	3...10 barg (43.5...145 psig) *2
Delivery pressure	> 3 bar (43.5 psi) *2 *3
PH	7.5...9.0
Total hardness	6.0...15 °dH
Conductivity	10...1000 µS/cm
Sulphates (SO ₄ ²⁻)	< 100 mg/l or ppm
Hydrogen carbonate / Sulphates (HCO ₃ / SO ₄ ²⁻)	> 1.0 mg/l or ppm
Ammonia (NH ₃)	< 0.5 mg/l or ppm
Manganous ion (Mn ²⁺)	< 0.05 mg/l or ppm
Chlorides (Cl ⁻)	< 50 mg/l or ppm
Free chlorine (Cl ₂)	< 0.5 mg/l or ppm
Oxygen content	< 0.1 mg/l or ppm
Carbon dioxide (CO ₂)	< 50 mg/l or ppm
Hydrogen sulphide (H ₂ S)	< 0.05 mg/l or ppm
Phosphate (PO ₄ ³⁻)	< 2 mg/l or ppm
Ferric ion (Fe ³⁺)	< 0.5 mg/l or ppm

*1 Other temperatures upon request – check the data on the name plate.

*2 Other pressures upon request – check the data on the name plate.

*3 Pressure difference at the water connection of the dryer at maximum water flow. Other prevalences upon request.



CAUTION!

During the piping of the dryer, the inlet and outlet connections need to be supported as is shown in the illustration.

Non-observance will cause damage.

8.7 Electrical connections



Danger!

Supply voltage!

The connection to the electric mains should only be carried out by qualified skilled personnel and must correspond to the legal provisions in force in your region.

Prior to connecting the device, please check the name plate to avoid exceeding the indicated values. The voltage tolerance is +/- 10%.

The installer is responsible for supplying and installing the power cable. Be sure to provide the proper fuses or breakers based on the data information located on the nameplate.

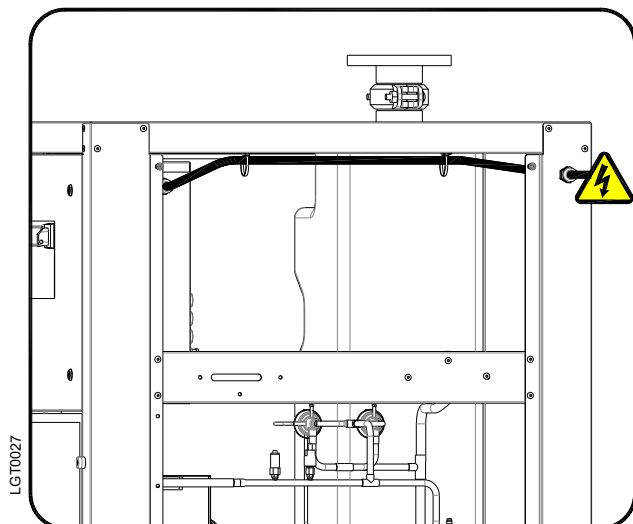

RA 1300-2200 eco

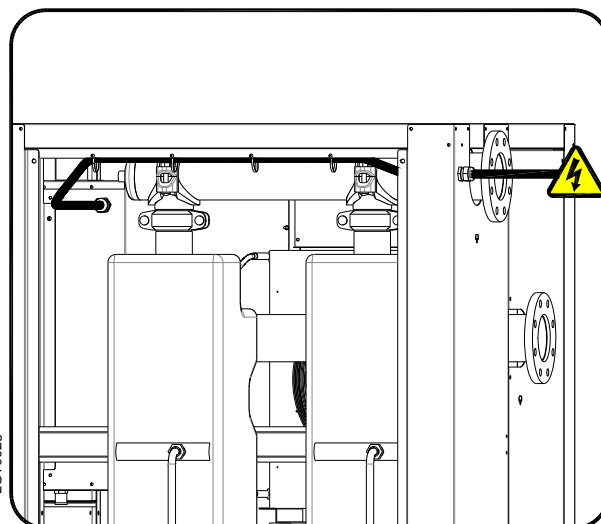

RA 2400-4400 eco

A residual-current device (RCD) with $I_{\Delta n} = 0.3A$, class B is suggested. The cross-section of the power supply cables must correspond to the consumption of the dryer. In this respect, the ambient temperature, the cable laying conditions, the length of the cables and the requirements of the local electricity supplier need to be considered.

Note!

Compressor and fan(s) proper rotation direction are managed automatically by the inverters.

It is not necessary to observe the phases sequence when connecting the power cable to the main switch.

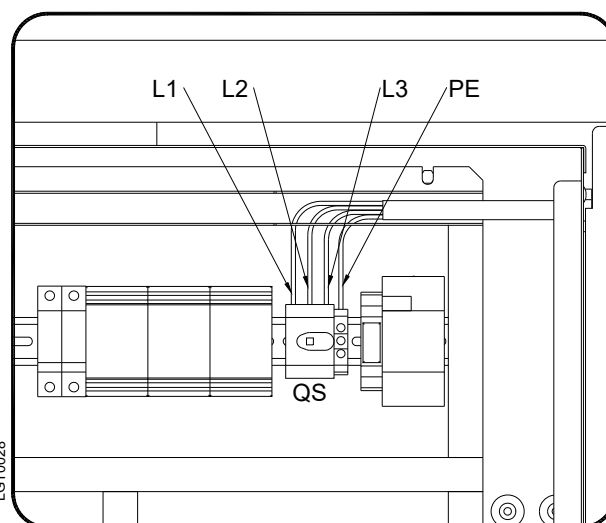

Danger!

Supply voltage and missing earth connection!

Important: ensure that the plant is connected to earth.

Do not use plug adapters at the power plug.

Possible replacement of the power plug must only be carried out by a qualified electrician.

Note!

This dryer is not suitable for employment on IT-systems.

This dryer is not suitable for employment on grounded-delta systems



8.8 Condensate drain



Danger!

Compressed air and condensate under pressure!

The condensate is discharged at system pressure.
The drain pipe needs to be secured.
Never direct the condensate drain pipe at persons.

The dryer is delivered with an already integrated electronically level-controlled BEKOMAT condensate drain. Connect the condensate drain with a collection system or container by properly screwing it on. Do not connect the drain with pressure plants.



Do not discharge the condensate into the environment.

The condensate accumulating in the dryer contains oil particles which were released into the air by the compressor.

Dispose of the condensate in accordance with the local provisions.

It is advisable to install a water-oil separator, to which the total amount of condensate from the compressors, dryers, tanks, filters etc. is supplied.

We recommend ÖWAMAT oil-water separators for dispersed compressor condensate and BEKOSPLIT emulsion-splitting plants for emulsified condensate.

9 Start-up

9.1 Preliminary stages



Note!

Exceeding of the operating parameters!

Ensure that the operating parameters comply with the nominal values indicated on the name plate of the dryer (voltage, frequency, air pressure, air temperature, ambient temperature etc.).

Prior to delivery, this dryer was thoroughly tested, packed and checked. Please verify the soundness of the dryer during the initial start-up and check the perfect functioning during the first operating hours.



The initial start-up must be carried out by qualified personnel.

During the installation and operation of this device, all national regulations regarding electronics and any other federal and state ordinances, as well as local provisions, need to be adhered to.



The operator and the user must ensure that the dryer is not operated without panels.

9.2 Initial start-up





Note!

The number of starts/stops by pressing the  button must be limited to six per hour. Irreparable damage can be caused by starting up the device too often.



The method below should be applied during the first start-up, after longer downtimes or subsequent to maintenance works.
The first start-up must be carried out by certified skilled personnel.

Processing sequence (observe Section 11.1 "Control panel")

1. Ensure that all steps of the "Installation" chapter have been carried out.
2. Ensure that the connection to the compressed-air system is in accordance with the provisions and that the lines are fixed and supported properly.
3. Ensure that the condensate drain pipe is fixed in accordance with the provisions and that it is connected with a collection system or a container.
4. Ensure that the bypass system (if installed) is open and that the dryer is isolated.
5. Ensure that the manual valve of the condensate outlet is open.
6. Ensure that the cooling-water flow and the temperature are in accordance with the provisions (water-cooled).
7. Remove any packaging material and other items which may block the space around the dryer.
8. Switch on the main switch.
9. Switch on the main switch on the control panel (pos. 1).
10. Wait about 45 seconds the initialization of the electronic controller DMC50.
11. Select the desired language and the current date and time (see Section 11.15.16)
12. **Wait at least two hours before starting the dryer (the crankcase heater of the compressor needs to heat up the compressor oil).**
13. Keep pressed the button  at least 3 seconds, the dryer starts and the display shows .
If the temperature shown on the display is sufficiently high, verify that the refrigerating compressor starts within a few minutes. **NOTE!** – With low temperatures, the refrigerating compressor will remain OFF.
14. Ensure the effective operation of the fan, watching its speed percentage on the display (air-cooled).
15. Wait until the dryer stabilises at the preset value.
16. Slowly open the air inlet valve.
17. Slowly open the air outlet valve.
18. Slowly close the central bypass valve of the system (if installed).
19. Check the pipes for air leakage.
20. Ensure that the drain discharges at regular intervals – wait for the first interventions.



Note!

A dew point between 0°C and +10°C (32°F and 50°F) displayed on the electronic controller is considered to be correct according to the possible operating conditions (flow rate, air inlet temperature, ambient temperature etc.).

The electronic controller DMC50 adjusts compressor and fan(s) speed according to thermal load applied to the dryer. At very low or no load conditions, compressor is switched ON and OFF by the DMC50 to keep the temperature of the heat exchanger cold, allowing a consistent additional energy saving. The dryer needs to be switched on during the entire compressed-air usage time, even if the compressed-air compressor works periodically



Note!

Compressor and fan(s) proper rotation direction are managed automatically by the inverters.
It is not necessary to observe the phases sequence when connecting the power cable to the main switch.

9.3 Start-up and shut down



During short-term shut down (max. two to three days), it is advisable to leave the dryer and the control panel connected to the supply current circuit. Otherwise, it would be necessary at a restart of the dryer to wait two hours, until the oil in the compressor has reached the specified operating temperature.



Start-up (see Section 11.1 "Control panel")

- Make sure that the condenser is clean (air-cooled).
- Make sure that the fan filter of electrical panel is clean.
- Ensure that the cooling-water flow and the temperature are in accordance with the provisions (water-cooled).
- The display of electronic controller shows **STANDBY**
- Keep pressed the button  at least 3 seconds, the dryer starts and the display shows **ON**.
- If the temperature shown on the display is sufficiently high, verify that the refrigerating compressor starts within a few minutes. **NOTE!** – With low temperatures, the refrigerating compressor will remain OFF.
- Wait for several minutes and then check whether or not the dew point temperature which is indicated on the display of the DMC50 electronics is correct and whether or not the condensate is discharged at regular intervals.
- Switch on the air compressor.



Shut down (see Section 11.1 "Control panel")

- Ensure that the dew point temperature indicated on the display is within the permissible range.
- Shut down the air compressor.
- Keep pressed the button  at least 3 seconds, the dryer stops and the display shows **STANDBY**.



Dryer remote control ON/OFF

- ◆ See instructions in Section 11.14.11



Note!

A dew point between 0°C and +10°C (32°F and 50°F) displayed on the electronic controller is considered to be correct according to the possible operating conditions (flow rate, air inlet temperature, ambient temperature etc.).

The electronic controller DMC50 adjusts compressor and fan(s) speed according to thermal load applied to the dryer. At very low or no load conditions, compressor is switched ON and OFF by the DMC50 to keep the temperature of the heat exchanger cold, allowing a consistent additional energy saving. The dryer needs to be **ON** during the entire compressed-air usage time, even if the compressed-air compressor works periodically.

10 Technical data

10.1 Technical data DRYPOINT RA 1300-4400 eco 3/400/50

MODEL	DRYPOINT RA eco						
Air flow rate at nominal condition (1)	1300	1800	2200	2400	2900	3600	4400
	1260	1800	2208	2400	2900	3600	4416
	21000	30000	36800	40000	48333	60000	73600
	742	1060	1300	1413	1707	2119	2600
Pressure DewPoint at nominal condition (1)	3						
	°C						
Nominal ambient temperature	25						
	°C						
Min...Max ambient temperature	1...45						
	°C						
Nominal inlet air temperature (max.)	35 (70)						
	°C						
Nominal inlet air pressure	7						
	[barg]						
Max. inlet air pressure	14						
	[barg]						
Air pressure drop - Δp	0.21	0.19	0.26	0.21	0.14	0.20	0.26
	[bar]						
Inlet - Outlet connections	DN80 PN16			DN100 PN16			
	[BSP-F]						

Air-Cooled		R407C						
Refrigerant type		R134.a						
Refrigerant quantity (2)	[kg]	3,50	4,00	4,60	6,00	6,50	7,50	9,50
Cooling air fan flow	[m3/h]	5400	7200	7400	14400			
Heat Rejection	[kW]	9,20	13,80	17,30	18,20	20,10	27,10	33,90
Standard Power Supply (2)	[PhV/Hz]	3/400/50						
Nominal electric consumption	[kW]	2,20	3,30	3,90	4,00	4,70	6,50	7,70
	[A]	3,9	5,4	6,1	6,3	7,3	10,5	12,1
Full Load Amperage FLA	[A]	7,8	10,0	12,0	14,6	15,8	19,6	24,0
Max. noise level at 1 m	[dbA]	< 75						
Weight	[kg]	248	282	317	470	545	549	621

Water-Cooled		R407C						
Refrigerant type		R134.a						
Refrigerant quantity (2)	[kg]	2,80	3,20	3,70	4,80	5,50	6,00	7,60
Max. cooling water inlet temp (3)	°C	30						
Min...Max. cooling water inlet pressure	[barg]	3 ... 10						
Cooling water flow at 30°C	[m3/h]	0,76	1,09	1,24	1,30	1,36	2,12	2,64
Heat Rejection	[kW]	9,20	13,80	17,30	18,20	20,10	27,10	33,90
Control of cooling water flow		Automatic by valve						
Cooling water connection	[BSP-F]	G 3/4"		G 1"				
Standard Power Supply (2)	[PhV/Hz]	3/400/50						
Nominal electric consumption	[kW]	2,00	2,60	3,20	3,60	4,10	5,30	6,50
	[A]	3,6	4,2	5,0	5,6	6,3	8,6	10,1
Full Load Amperage FLA	[A]	6,5	8,1	10,2	10,8	12,0	15,8	20,2
Max. noise level at 1 m	[dbA]	< 70						
Weight	[kg]	231	261	292	435	502	506	568

(1) The nominal condition refers to an ambient temperature of +25°C with inlet air at 7 barg and +35 °C.

(2) Check the data shown on the identification plate.

(3) Other temperature on request.

MODEL	DRYPOINT RA eco						
Air flow rate at nominal condition (1)	1300-R	1800-R	2200-R	2400-R	2900-R	3600-R	4400-R
	1260	1800	2208	2400	2900	3600	4416
	[m ³ /h]						
	21000	30000	36800	40000	48333	60000	73600
	[l/min]						
	742	1060	1300	1413	1707	2119	2600
	[scfm]						
Pressure DewPoint at nominal condition (1)	3						
	°C						
Nominal ambient temperature	25						
	°C						
Min...Max ambient temperature	1...45						
	°C						
Nominal inlet air temperature (max.)	35 (70)						
	°C						
Nominal inlet air pressure	7						
	[barg]						
Max. inlet air pressure	14						
	[barg]						
Air pressure drop - Δp	0.21	0.19	0.26	0.21	0.14	0.20	0.26
	[bar]						
Inlet - Outlet connections	DN80 PN16			DN100 PN16			
	[BSP-F]						

Air-Cooled		R407C						
Refrigerant type	R134.a							
Refrigerant quantity (2)	[kg]	3,50	4,00	4,60	6,00	6,50	7,50	9,50
Cooling air fan flow	[m ³ /h]	5400	7200	7400	14400			
Heat Rejection	[kW]	9,20	13,80	17,30	18,20	20,10	27,10	33,90
Standard Power Supply (2)	[PhV/Hz]	3/400/50						
Nominal electric consumption	[kW]	2,20	3,30	3,90	4,00	4,70	6,50	7,70
	[A]	3,4	4,7	5,3	5,5	6,3	9,1	10,6
Full Load Amperage FLA	[A]	6,9	8,9	10,6	13,1	14,2	17,5	21,2
Max. noise level at 1 m	[dbA]	< 75						
Weight	[kg]	248	282	317	470	545	549	621

Water-Cooled		R407C						
Refrigerant type	R134.a							
Refrigerant quantity (2)	[kg]	2,80	3,20	3,70	4,80	5,50	6,00	7,60
Max. cooling water inlet temp (3)	°C	30						
Min...Max. cooling water inlet pressure	[barg]	3 ... 10						
Cooling water flow at 30°C	[m ³ /h]	0,76	1,09	1,24	1,30	1,36	2,12	2,64
Heat Rejection	[kW]	9,20	13,80	17,30	18,20	20,10	27,10	33,90
Control of cooling water flow		Automatic by valve						
Cooling water connection	[BSP-F]	G 3/4"		G 1"				
Standard Power Supply (2)	[PhV/Hz]	3/400/50						
Nominal electric consumption	[kW]	2,00	2,60	3,20	3,60	4,10	5,30	6,50
	[A]	3,1	3,6	4,4	4,9	5,5	7,5	8,8
Full Load Amperage FLA	[A]	5,6	7	8,7	9,3	10,4	13,7	17,4
Max. noise level at 1 m	[dbA]	< 70						
Weight	[kg]	231	261	292	435	502	506	568

(1) The nominal condition refers to an ambient temperature of +25°C with inlet air at 7 barg and +35 °C.

(2) Check the data shown on the identification plate.

(3) Other temperature on request.

11 Technical description

11.1 Control panel

The control panel explained below is the only dryer user interface.

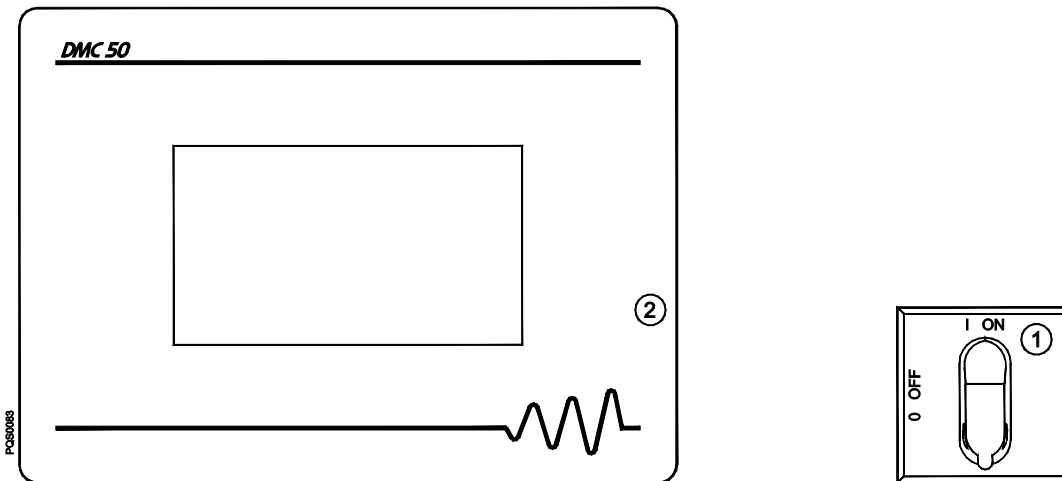

Main switch
Electronic controller DMC50

11.2 Functional description

Operating principle – The dryer models described in this manual operate all on the same principle. The hot moisture laden air enters an air to air heat exchanger. The air then goes through the evaporator, also known as the air to refrigerant heat exchanger. The temperature of the air is reduced to approximately 2°C, causing water vapor to condense to liquid. The liquid is continuously coalesced and collected in the separator for removal by the condensate drain. The cool moisture free air then passes back through the air to air heat exchanger to be reheated to within 8 degrees lower than the incoming air to the dryer.

Refrigeration cycle – Refrigerant gas is exhausted by the compressor and exits at high pressure towards a condenser where heat is removed causing the refrigerant to condense to a high-pressure liquid state. The liquid is forced through an electronic expansion valve (EEV) where the resulting pressure drop allows the refrigerant to boil off at a predetermined temperature. Low-pressure liquid refrigerant enters the heat exchanger where heat from the incoming air is transferred causing the refrigerant to boil; the resulting phase change produces a low pressure and low temperature gas. Then the low-pressure gas goes back to the compressor, where it is re-compressed and begins the cycle again.

Operation of the eco mode (Variable Speed) – The DMC50 electronic controller constantly monitors the evaporating pressure (BLP), the condensing pressure (BHP) and the temperature of the DewPoint (BT1).

At each compressor start-up compressor's speed is forced to a fixed speed for approx. 3 minutes to allow a proper oil circulation in the refrigerant circuit. During this period, if the evaporating pressure (BLP) falls too low, DMC50 will activate a solenoid valve EVB that will increase the evaporating pressure above the freezing point.

Expired the first 3 minutes, DMC50 will adjust compressor's speed in order to keep the evaporating pressure almost constant, allowing a constant DewPoint even with dryer thermal load variation. In low load conditions, compressor will run at its lowest allowable speed. If that speed is larger than load demand, the evaporating pressure will decrease from its setting point and when the temperature of the DewPoint tends to fall close to the freezing point, the DMC50 controls the switching off of the compressor.

The compressor will be started again when the DewPoint temperature and evaporating pressure rises above a target value. The check valve CHV in combination with the Electronic Expansion Valve (EEV) help to extend the off time of the compressor and avoid the immediate balancing of high and low pressures of the refrigerant circuit.

The solenoid valve EVB is activated before the compressor start as long as refrigerant pressures (low and high) get balanced. Fan(s) speed will be controlled by the DMC50 in order to keep the condensing pressure measured by BHP almost constant (Air-Cooled).

With these dryers, the energy consumption will be adjusted closely proportional to the thermal load applied to the dryer itself, allowing considerable energy savings in the majority of applications.

11.3 Flow chart (air-cooled)

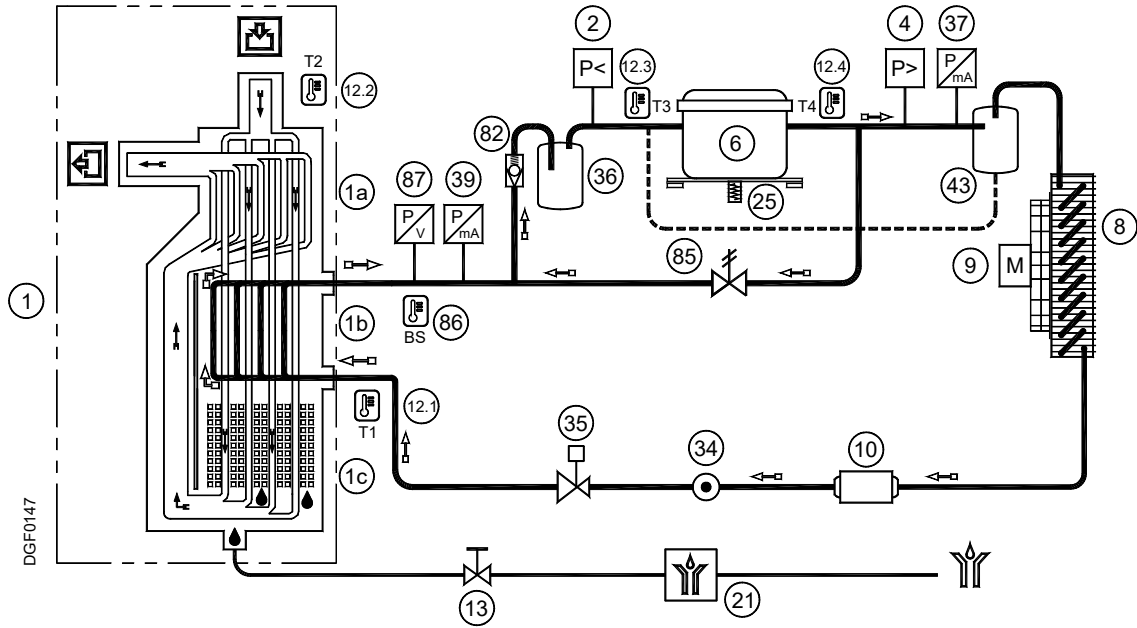

11.4 Flow chart (water-cooled)

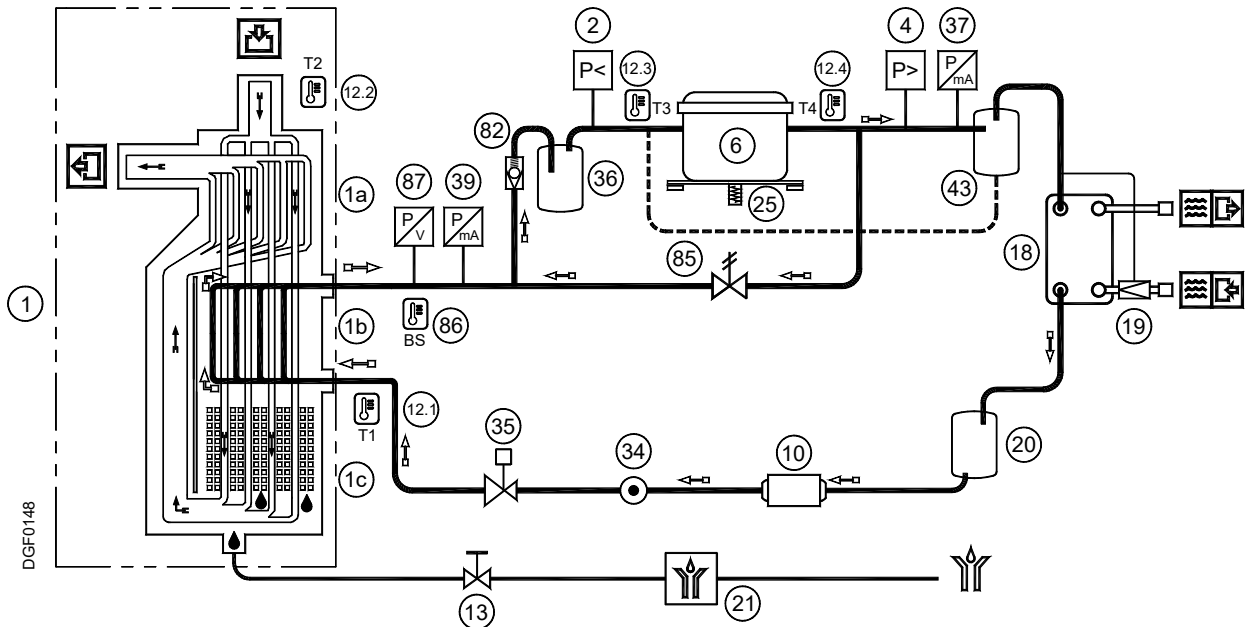

- | | |
|---|---|
| <p>1 Alu-Dry module</p> <p>1a Air-to-air heat exchanger</p> <p>1b Air-to-refrigerant heat exchanger</p> <p>1c Condensate separator</p> <p>2 Refrigerant pressure switch LPS</p> <p>4 Refrigerant pressure switch HPS</p> <p>6 Compressor</p> <p>8 Condenser (Air-Cooled)</p> <p>9 Condenser fan (Air-Cooled)</p> <p>10 Filter dryer</p> <p>12.1 T1 Temperature probe – DewPoint</p> <p>12.2 T2 Temperature probe – Air IN</p> <p>12.3 T3 Temperature probe – Compressor suction</p> <p>12.4 T4 Temperature probe – Compressor discharge</p> <p>13 Condensate drain service valve</p> <p>➡ Compressed air flow direction</p> | <p>18 Condenser (Water-Cooled)</p> <p>19 Condenser water regulating valve (Water-Cooled)</p> <p>20 Refrigerant accumulator (Water-Cooled)</p> <p>21 Electronic drainer</p> <p>25 Compressor crankcase heater</p> <p>34 Liquid sight glass</p> <p>35 Electronic Expansion Valve EEV</p> <p>36 Liquid separator</p> <p>37 Refrigerant pressure transducer BHP</p> <p>39 Refrigerant pressure transducer BLP</p> <p>43 Oil separator (RA 3600 - 4400)</p> <p>82 Check valve CHV</p> <p>85 Pressure balancing solenoid valve EVB</p> <p>86 Electronic Expansion Valve temperature sensor BS</p> <p>87 Electronic Expansion Valve pressure transducer BP</p> <p>➡ Refrigerant gas flow direction</p> |
|---|---|

11.5 Refrigerating compressor

The refrigerating compressor is the pump in the system, gas coming from the evaporator (low pressure side) is compressed up to the condensation pressure (high pressure side).

It is used a scroll fully hermetic compressor encapsulated with a BLDC (Brush Less Direct Current) motor which is the latest and most efficient technology available for this application. Compressor motor speed is completely handled by an heavy duty variable speed drive, with a customized software capable to ensure a very wide capacity regulation. Compressor motor protection is completely managed by the variable speed drive.

11.6 Condenser (air-cooled)

The condenser is the component in which the gas coming from the compressor is cooled down and condensed becoming a liquid. Mechanically, a serpentine copper tubing circuit (with the gas flowing inside) is encapsulated in an aluminium fin package.

The cooling operation occurs via a high efficiency fan(s) AC motor, creating airflow within the dryer, moving air through the fin package. The fan(s) motor speed is completely handled by an heavy duty variable speed drive, with a customized software capable to ensure a very wide capacity regulation.

It's mandatory that the ambient air temperature does not exceed the nominal values. It is also important to keep the condenser unit free from dust and other impurities.

11.7 Condenser (water-cooled)

The condenser is the component in which the gas coming from the compressor is cooled down and condensed becoming a liquid. Basically it is a water/refrigerating gas exchanger where the cooling water lowers the temperature of the refrigerating gas.

The temperature of the inlet water must not exceed the nominal values. It must also guarantee an adequate flow and that the water entering the exchanger is free from dust and other impurities.

11.8 Cooling-water regulating valve

The condenser water regulating valve is used to keep the condensing pressure/temperature constant when the Water-Cooled is being used. Thanks to the capillary tube, the valve detects the pressure in the condenser and consequently adjusts the water flow. When the dryer stops the valve automatically closes the cooling water flow.



The condenser water regulating valve is an operating control device.

The closure of the water circuit from the pressure condenser water regulating valve cannot be used as a safety closure during service operations on the system.



ADJUSTMENT

The condenser water regulating valve is adjusted during the testing phase to a pre-set value that covers 90% of the applications. However, sometimes the extreme operating conditions of the dryer may require a more accurate calibration.

During start-up, a qualified technician should check the condensing pressure/temperature and if necessary adjust the valve by using the screws on the valve itself.

To increase the condensing temperature, turn the adjusting screws counter-clockwise; to lower it turn the screws clock-wise.

Water valve setting : R134.a pressure 10 barg (± 0.5 bar) / 145 psig (± 7 psi)
R407C pressure 15 barg (± 0.5 bar) / 218 psig (± 7 psi)

11.9 Filter dryer

Despite controlled vacuuming, traces of moisture can accumulate in the refrigeration cycle. The filter dryer serves to absorb this moisture and to bond it.

11.10 Electronic Expansion Valve (EEV)

The electronic expansion valve (EEV) is an expansion device which is composed by a valve body operated from a stepper motor. This component is managed from its driver according to heat exchanger superheating.

This parameter is calculated from the driver using a temperature sensor BS and a pressure sensor BP installed at evaporator outlet refrigerant pipe. The driver operates the motor opening or closing the electronic expansion valve (EEV) in order to keep constant at the setpoint the superheating.

On this dryer type, every Alu-Dry module has its electronic expansion valve EEV which control its superheating independently.

In case of multiple Alu-Dry module (1...n), every group composed by electronic expansion valve EEV (1...n), every temperature sensor BS (1...n), every pressure sensor BP (1...n) and every driver DRV (1...n) is marked with a sticker. The number on the sticker (1...n) identify the valve group.

11.11 Alu-Dry module

The heat exchanger module houses the air-to-air, the air-to-refrigerant heat exchangers and the demister type condensate separator. The counter flow of compressed air in the air-to-air heat exchanger ensures maximum heat transfer. The generous cross section of flow channel within the heat exchanger module leads to low velocities and reduced power requirements. The generous dimensions of the air-to-refrigerant heat exchanger plus the counter flow gas flow allows full and complete evaporation of the refrigerant (preventing liquid flood back to the compressor). The high efficiency condensate separator is located within the heat exchanger module. No maintenance is required and the coalescing effect results in a high degree of moisture separation.

11.12 Refrigerant pressure switches LPS – HPS

To ensure the operational reliability and the protection of the dryer, a series of pressure switches are installed in the gas cycle.

LPS : Low-pressure guard on the suction side of the compressor, which is triggered when the pressure drops below the predetermined value. The values are reset automatically as soon as the nominal conditions are re-established.

Calibrated pressure:	R134.a	Stop 0.7 barg / 10,2 psig - Restart 1.7 barg / 24,7 psig
	R407C	Stop 1.7 barg / 24,7 psig - Restart 2.7 barg / 39,2 psig

HPS : This high-pressure controller device, located on the discharge side on the compressor, is activated when the pressure exceeds the pre-set value. It features a manual-resetting button mounted on the protection device.

Calibrated pressure:	R134.a	Stop 20 barg / 290 psig - Manual reset (P<14 bar / 203 psig)
	R407C	Stop 30 barg / 435 psig - Manual reset (P<23 bar / 334 psig)

11.13 Compressor crankcase heater

At low temperatures oil can more easily be mixed with the refrigerant gas. So, when the compressor starts, oil can be drawn into the refrigeration circuit and liquid flood back to the compressor could occur.

To prevent this, an electrical resistance heater is installed in the bottom part of the compressor. When the system is powered and the compressor is not running, this heater keeps the oil at the correct temperature.



Note!

During short-term shut down (max. two to three days), it is advisable to leave the dryer and the control panel connected to the supply current circuit. Otherwise, it would be necessary at a restart of the dryer to wait two hours, until the oil in the compressor has reached the specified operating temperature.

11.14 Electrical panel fan

Drivers enclosed in the electrical panel dissipates a consistent amount of heat. If the electrical panel temperature rises above a set limit (40 °C), a dedicated fan is activated to keep properly cooled the electrical panel and the drivers. It is important to keep the electric panel air intake filter free from dust and other impurities, furthermore it must be regularly cleaned.

NOTE!- With low temperatures, the electric panel fan will remain OFF

11.15 DMC50 electronic control unit

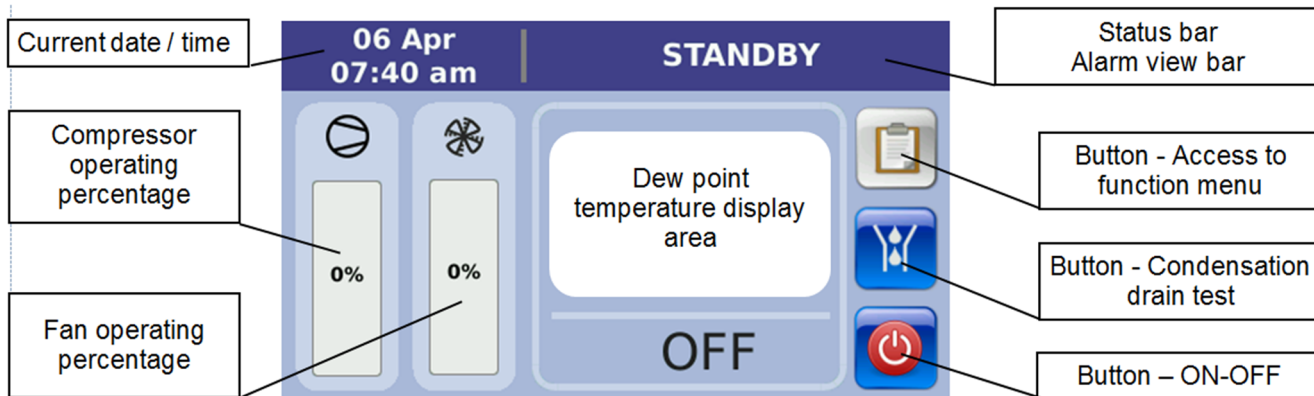

The DMC50 electronic control unit is a device which controls the dryer's functional processes, provides a dialogue interface for the operator, and consists of a controller module with touchscreen positioned on the front panel of the dryer. Both modules are connected together via connection cable (data transfer) and connection cable (power supply). The operator can use the touchscreen to manage operating functions, view alarms/service warnings, and set dryer process parameters.

Switch ON the dryer by means of the main switch (pos.1 of control panel - see section 11.1) and wait for the DMC50 control unit initialisation process. After about 45 seconds the display will show the main screen :



0.25

11.15.1 Starting the dryer ("ON" mode)

Hold the  button for 3 seconds to start the dryer. The dryer will begin the WARM-UP phase and the status bar will turn green and display .

NOTE!



During the WARM-UP phase, which lasts about 3 minutes, the compressor works at a set speed to enable the lubricating oil to circulate correctly in the compressor at the beginning. This phase is illustrated with a bar symbol under the compressor icon, which gradually becomes blue and shows the time that has lapsed since the dryer started. Once the dryer has warmed up the bar symbol disappears and the dryer start to operate in load dependent mode.

The display will show:

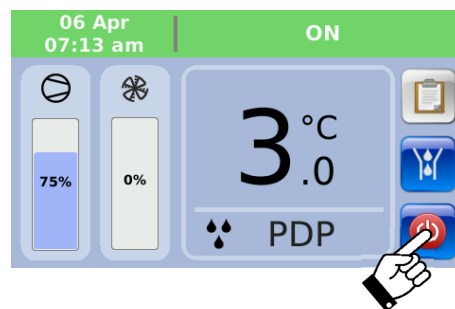
- ⇒ Compressor operating percentage (0-100%)
- ⇒ Fan operating percentage (0-100%) – Air-Cooled only
- ⇒ Dew point temperature
- ⇒ Dryer status, realtime clock and data



11.15.2 Stopping the dryer ("STANDBY" mode)

Hold the  button for 3 seconds to stop the dryer. The dryer will stop (STANDBY) and the status bar will turn blue and display .

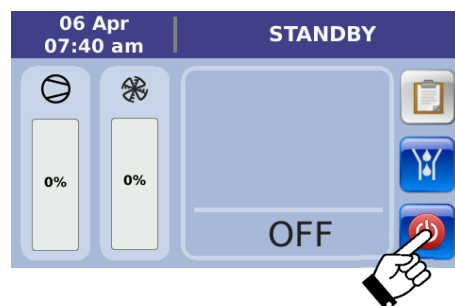

11.15.3 Performing the condensation drain test

Hold the  button to perform the condensation drain test. Release the button to finish the condensation drain test.

NOTE!



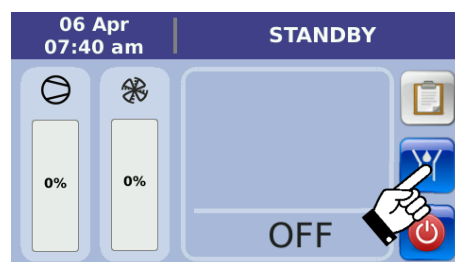

The condensation drain test can be performed at any time, regardless of the dryer status displayed on the status bar (ON, STANDBY, ALARM, SERVICE WARNING).





11.15.4 Displaying process values T1, T2, T3, T4, HP, LP, %, %

1- With the dryer operating (ON mode) press the  button to access the dryer's menu.

2- Press the  button to display the refrigeration circuit diagram and the dryer's instantaneous process values:



- **T1** - Value measured by the BT1 probe in °C or °F (Dew Point temperature)
- **T2** - Value measured by the BT2 probe in °C or °F (Air temperature at exchanger inlet)
- **T3** - Value measured by the BT3 probe in °C or °F (Temperature of refrigerant gas on compressor suction side)
- **T4** - Value measured by the BT4 probe in °C or °F (Temperature of refrigerant gas on compressor discharge side)
- **HP** - Value measured by the BHP probe in bar or psi (Pressure of refrigerant gas on compressor discharge side)
- **LP** - Value measured by the BLP probe in bar or psi (Pressure of refrigerant gas on compressor suction side)
- %  - Percentage value of compressor operation
- %  - Percentage value of fan operation
-  - Pressure balancing solenoid valve active (powered)
-  - Pressure balancing solenoid valve not active (not powered)

3- Hold the  button to perform the condensation drain test. Release the button to finish the condensation drain test.

4- Press the  button to display the log file process values expressed graphically or numerically for the last 60 minutes of dryer operation. The default graph includes traces for all 8 process values.

5- Use the **T1 T2 T3 T4 HP LP**   buttons to display/hide the corresponding coloured traces.

6- Touch the graph on the screen to position the cursor roughly near the required time.

7- Use the   buttons to fine tune the position of the graph cursor on the required time. Positioning accuracy is +/- 1 minute.

8- The table on the right of the screen displays the process values stored in the time period selected by the graph cursor in numerical format.

9- Press the  button to return to the previous screen.

NOTE!

The stored process values, which are available in numerical or graph format, relate to the last 60 minutes of dryer operation. Stored process values that are not within this time frame are permanently deleted automatically.

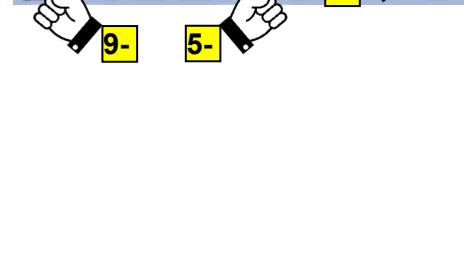
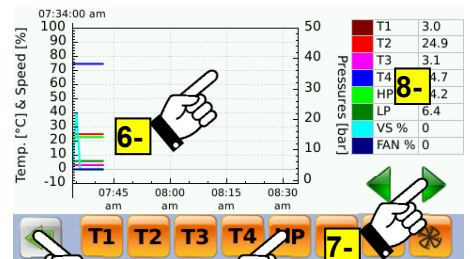
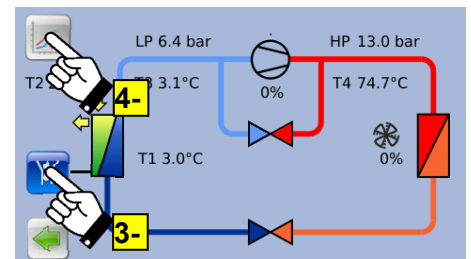
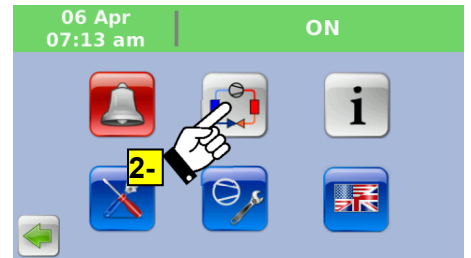
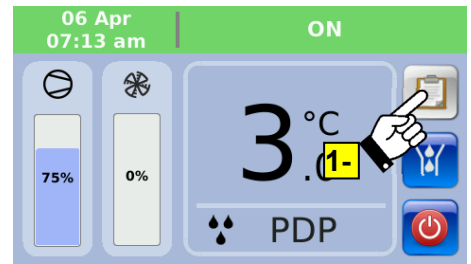

11.15.5 How the DMC50 control unit displays and processes a service warning

The **service warning** is an irregular event that must be flagged to operators/maintenance technicians. It does not jeopardise the safety of the machine/operators and it does not stop the dryer, with the exception of the HdS parameter (STOP dryer due to high dew point, see section 11.15.14), which can be set to stop the dryer.

In the presence of a service warning, the status bar shows a description of the event and turns flashing orange. In this condition it is not possible to reset the service warning as the cause is still present.

When a service warning is no longer active but has not been reset, the status bar shows a description of the event and is permanently lit (orange). In this condition the service warning can be reset as the cause has been removed.

With dryer operating (ON): the presence of one or more service warnings is flagged on the display with the status bar changing from green to orange.

With the dryer stopped (STANDBY): the presence of one or more service warnings is not flagged at all on the display.

It is only when the operator wants to start the dryer with the  button that the DMC50 control unit still enables the dryer to be started in the presence of a service warning, and displays the warning status by changing the colour of the status bar (orange).

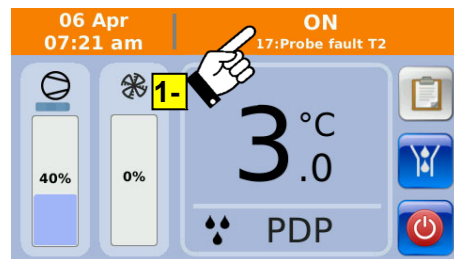

Resetting a service warning:

- 1- Touch the screen on the status bar where the service warning is shown.
- 2- Confirm the service warning is to be reset with OK, or exit without resetting with Cancel.

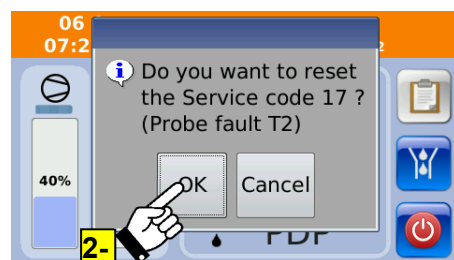

NOTE!

After resetting service warnings, the operator/maintenance technician must verify/solve the problem that caused the service warning.

Service warnings never reset automatically, with the exception of service warning no. 19 (malfunction of electronic condensation drainer), which is factory-set to enable automatic resetting (Ard parameter → Yes setting, see section 8.15.14).

Service ID	Description	Set	Delay	Reset
15	- Low Dew Point - Dew point temperature T1 too low	T1 < -1°C (30.2°F)	5 minutes	T1 > 0°C (32°F)
16	- High Dew Point - Dew point temperature T1 too high	T1 > HdA parameter	Parameter Hdd	Parameter HdA-1°K (2°F)
17	- Probe Fault T2 - T2 temperature probe fault	-	Flag immediately	Restore probe
18	- Probe Fault T3 - T3 temperature probe fault	-	Flag immediately	Restore probe
19	- Drainer - Malfunction of ELD electronic condensate drain	Contact open	20 minutes	Restore contact
20	- Programmed service - Scheduled service time expired	Parameter SrV	Flag immediately	-
21	- High Discharge Temperature - Temp. T4 compressor discharge over normal limits but within safe limits	T4 > 100°C (212°F)	60 seconds	T4 < 95°C (203°F)
22	- High Evaporating Pressure -	R134.a 4.0 barg (58,0 psig) R407C 6.8 barg (98,6 psig)	60 seconds	R134.a 4.0 barg (58,0 psig) R407C 6.8 barg (98,6 psig)
23	- Low Condensing Pressure -	Variable	180 seconds	Variable
24	- High Condensing Pressure -	Variable	180 seconds	Variable
169201 169318	Specific compressor variable speed drive service warnings Consult the variable speed drive manual			

NOTE!

Service warning no. 19 (drainer) could appear if the dryer operates without compressed air flow.

11.15.6 How the DMC50 control unit displays and processes an alarm

The alarm is an irregular event that always causes the dryer to stop to ensure the safety of operators and the machine. In the presence of an alarm the status bar shows a description of the event and turns flashing red. In this condition it is not possible to reset the alarm as the cause is still present.





When an alarm is no longer active but has not been reset, the status bar shows a description of the event and is permanently lit (red). In this condition the alarm can be reset as the cause has been removed.

With dryer operating (ON): the presence of one or more alarms is flagged on the display with the status bar changing from green to red.

With the dryer stopped (STANDBY): the presence of one or more alarms is not flagged at all on the display, with the exception of alarm no. 6 (ICE) which is the only alarm which is displayed and automatically resets with the dryer stopped (STANDBY).

It is only when the operator wants to start the dryer with the  button that the DMC50 control unit prevents the dryer starting up in the presence of an alarm and displays the alarm status by changing the colour of the status bar (red).

Resetting an alarm:

- 1- Touch the screen on the status bar where the alarm is shown to display the list of stored alarms.
- 2- Touch the screen on the alarm to be reset.
- 3- Confirm the alarm is to be reset with OK, or exit without resetting with Cancel.
- 4- Touch the screen on the alarm just reset to display the dryer process values for the 60 minutes of operation immediately preceding the occurrence of the event.
- 5- Scroll through the stored process values using the   buttons.
- 6- Press the  button to return to the previous screen.
- 7- Use the  button to download process values in .txt format for possible analysis/diagnostics. See the detailed procedure for downloading values in the section 11.15.8.
- 8- Press the  button to return to the previous screen at any time.

NOTE!

The dryer must be restarted manually by the operator/maintenance technician after alarms are reset. Automatic restart is not available after an alarm has been reset. Before restarting, the operator/maintenance technician must verify/solve the problem that caused the alarm on the dryer. Alarms are never reset automatically (with the exception of alarm no. 6 ICE with the dryer stopped (STANDBY)).

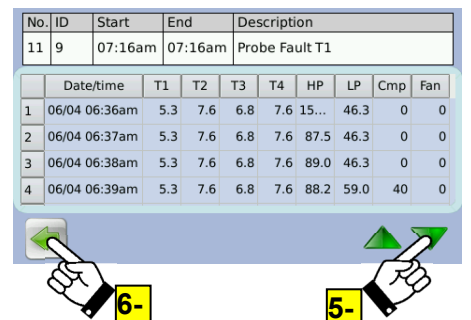
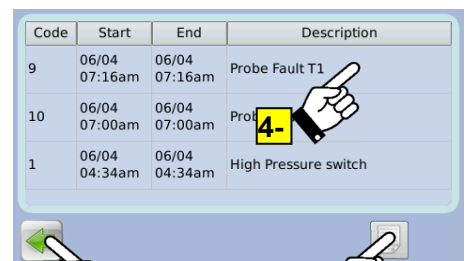
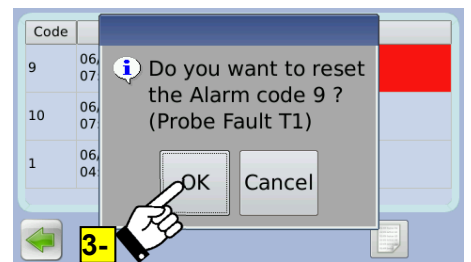
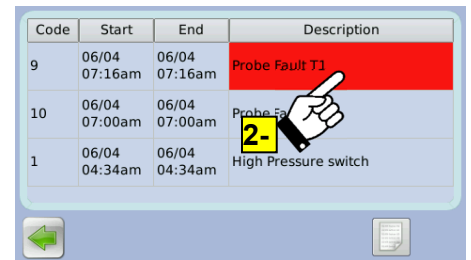
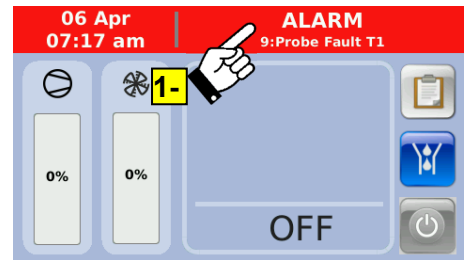



Alarm ID	Description	Set	Delay	Reset
1	- Pressure switches - Pressure switch HPS or LPS has triggered Refrigerant pressure High or LOW	Contact open	Flag immediately	Restore contact
2	- Expansion valve - Electronic Expansion Valve EEV fault	Contact open	Flag immediately	Restore contact
3	- Fan Protection - Fan electrical protection has triggered Fan motor overload	Contact open	Flag immediately	Restore contact
4	- High Discharge Temperature - Temperature T4 compressor discharge over safety limits	T4>110°C (230°F)	60 seconds	T4<100°C (212°F)
5	- Compressor Protection - QC1 circuit breaker has tripped Compressor overload	C. breaker tripped	Flag immediately	Restore C.breaker
6	- ICE - Temperature T1 exchanger too low. Condensation frozen	T1 < -3°C (26.6°F)	60 seconds	T1 > 0°C (32°F)
7	- Probe Fault LP - LP pressure transducer fault	-	Flag immediately	Restore transducer
8	- Probe Fault HP HP pressure transducer fault	-	Flag immediately	Restore transducer
9	- Probe Fault T1 - T1 temperature probe fault	-	Flag immediately	Restore probe
10	- Probe Fault T4 - T4 temperature probe fault	-	Flag immediately	Restore probe
11	- Low Differential Pressure - Low differential pressure between the values measured by BHP and BLP	HP-LP < 2.5 bar (96,3 psi)	60 seconds	HP-LP > 2.5 bar (96,3 psi)
12	- High Evaporating Pressure -	R134.a 4.5 barg (65,3 psig) R407C 7.3 barg (105,9 psi)	10...15 minutes	-
13	- Low Condensing Pressure -	Variable	10...15 minutes	-
1001	- Power Unit Communication Lost - Communication fault between the DMC50 electric control unit and the controller module			
1002	- Compressor variable speed drive Communication Lost - Communication fault between the DMC50 electric control unit and the compressor variable speed drive			
169001	Specific compressor variable speed drive alarms			
169118	Consult the variable speed drive manual			



11.15.7 Displaying the log file of stored alarms

1- With the dryer stopped (STANDBY) or operating (ON mode), press the  button to access the dryer's menu of functions.

2- Press the  button to display the log file for the last 50 alarms stored.

3- Scroll through the list of alarms using the   buttons. Alarms are stored chronologically. The most recent event is added to the top of the list and replaces the oldest which is removed from the bottom of the list.

4- Touch the screen on the alarm just reset to display the dryer process values for the 60 minutes of operation immediately preceding the occurrence of the alarm in question.

5- Scroll through the stored process values using the   buttons.

6- Press the  button to return to the previous screen.

7- Use the  button to download process values in .txt format for possible analysis/diagnostics. See the detailed procedure for downloading values in the section 11.15.8.

8- Press the  button to return to the previous screen at any time.

NOTE!

Only alarms are stored in the log file. Service warnings are not stored. If power is cut off from the dryer, the log file with the stored alarms will NOT be deleted.

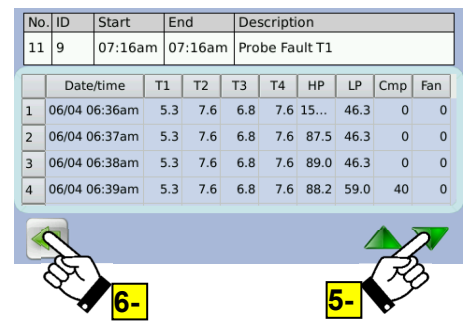
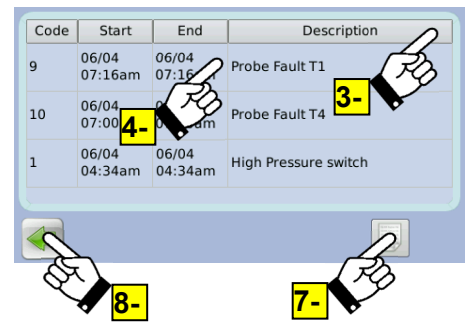
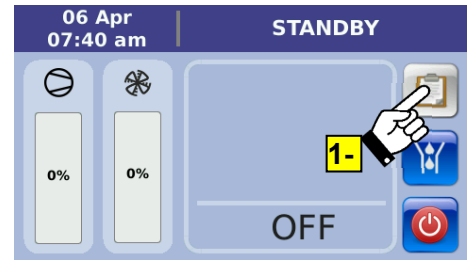

11.15.8 Downloading the process values stored following an alarm



NOTE!

The following operation must exclusively be carried out by authorised and qualified skilled personnel.

Process values for stored alarms can be downloaded in .txt format onto a USB stick after resetting an alarm (see section 11.15.6, step 7-), or from the screen for consulting the alarms log file (see section 11.15.7, step 7-).

Preliminary steps

- Switch OFF the dryer by means of the main switch (pos.1 of control panel - see section 11.1)
- Open the control panel door with the special key provided with the dryer.
- Insert a formatted USB stick in the relevant port on the back of the touch screen display module.
- Close the control panel door carefully.
- Switch ON the dryer.



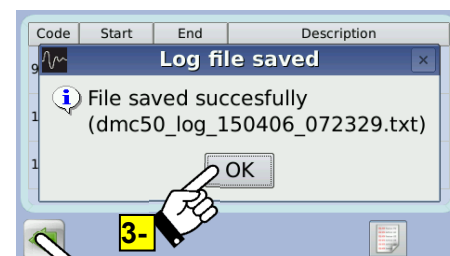
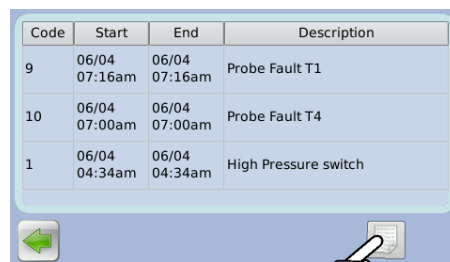

- 1- Press the  button to access the process value download function.
- 2- Confirm that the process values are to be downloaded with OK, or exit the operation with Cancel.
- 3- Confirm the download operation was successful with OK.
- 4- Press the  button to return to the previous screens

Final steps

- Switch OFF the dryer by means of the main switch (pos.1 of control panel - see section 11.1)
- Open the control panel door with the special key provided with the dryer.
- Remove the USB stick.
- Close the control panel door carefully.
- Switch ON the dryer.



11.15.9 Displaying instantaneous process values for the compressor inverter

- 1- With the dryer operating (ON mode), press the  button to access the dryer's menu of functions.
- 2- Press the  button to display the list of instantaneous process values for the compressor variable speed drive.
- 3- Scroll through the list of values using the   buttons.
- 4- Press the  button to return to the previous screen at any time.

NOTE!

The dryer must be started and the compressor running to show the current compressor variable speed drive process values. With dryer stopped (STANDBY) all values shown are "0"

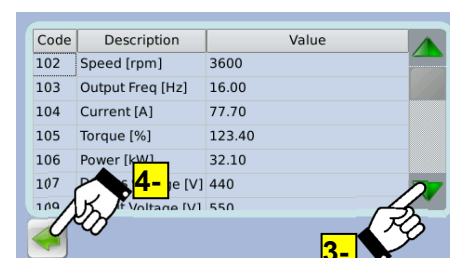
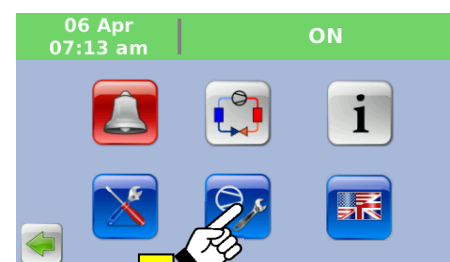
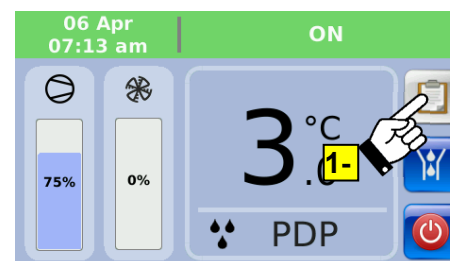

11.15.10 Displaying technical maintenance and energy savings data

1- With the dryer stopped (STANDBY) or operating (ON mode), press the  button to access the dryer's menu of functions.

2- Press the  button to display:

- 2a- The total percentage of energy savings for the variable speed dryer, with respect to its continuous operation at 100%.
- 2b- The partial percentage (starting from the last time the counter was zeroed) of energy savings for the variable speed dryer, with respect to its continuous operation at 100%.
- 2c- The date the partial energy savings counter was last zeroed.
- 2d- The total hours of dryer operation.
- 2e- The total hours of variable speed compressor operation.
- 2f- The total hours of 1st fixed speed compressor operation (not installed).
- 2g- The total hours of 2nd fixed speed compressor operation (not installed).
- 2h- The hours remaining till the next service.
- 2i- The partial hours of dryer operation, starting from the last time the counter was zeroed.

NOTE!

The following operation must exclusively be carried out by authorised and qualified skilled personnel.

3- With dryer stopped (STANDBY mode), press the Reset button to reset the count of the hours remaining before the next service (parameter SrV → default 8000 hours). This function is useful in the case of maintenance carried out on the dryer before the hours remaining till the next service have lapsed. This is a password-protected function (password code 3333) to prevent the counter being reset accidentally.

4- Press the Reset button to zero the partial energy savings counter.

5- Confirm the counter is to be zeroed with OK, or exit without zeroing with Cancel.

6- Press the  button to return to the previous screen at any time.

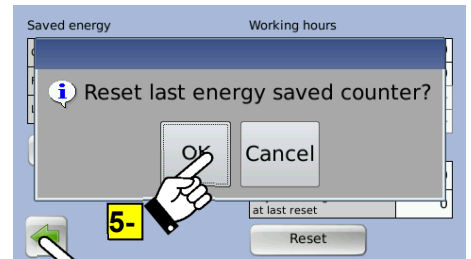
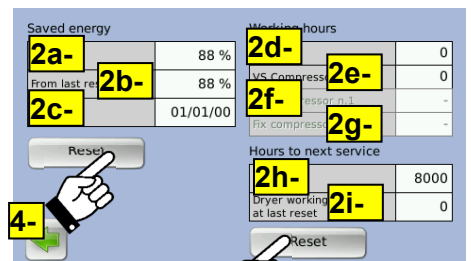
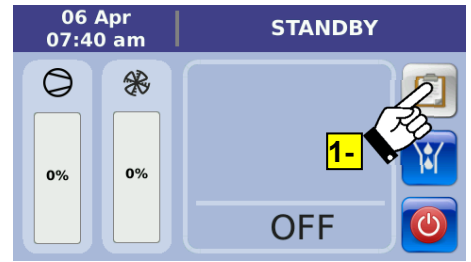

11.15.11 Controlling the dryer from a remote workstation

The controller module on the DMC50 control unit is provided with a digital input set up for dryer start up (ON) - stop (STANDBY) mode from a remote workstation.

1- Only qualified and skilled personnel are authorized to run electrically-operated devices. Prior to undertaking maintenance measures at the device, the following requirements must be met:

Make sure that the power supply is switched off and that the device is off and marked for maintenance measures. Please also ensure that the power supply cannot be re-established during the works

2- Wire a clean contact, free from electric potential, to terminals 17 and 18 on the DCM50 control unit's main module.

3- Set the DrC parameter to REMOTE mode (see section 11.15.14).

4- Close the contact. The dryer will start up and the status bar will turn green and display REMOTE ON.

5- Open the contact. The dryer will stop and the status bar will turn blue and display REMOTE STANDBY.

NOTE!

The dryer cannot be started up and stopped from the touch screen display when in REMOTE mode. However it is possible to carry out all other operations, such as the condensation drain test, the management of alarms/service warnings, and access functions menus.



Use dry contacts only (potential free) suitable for low voltage. Ensure an adequate insulation on potentially dangerous powered parts.

11.15.12 How the alarm / service warning flagging contact operates

The controller module on the DMC50 control unit is provided with a clean contact, free from electric potential, for remotely flagging dryer alarm/warning conditions.

1- Set the ACM (Alarm Contact Management) parameter to the required mode (see section 11.15.14).

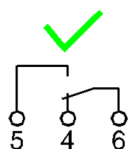

Dryer powered and absence of the conditions checked with the ACM parameter settings

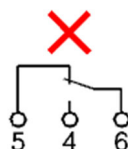

Dryer not powered or presence of at least one of the conditions checked with the ACM parameter settings

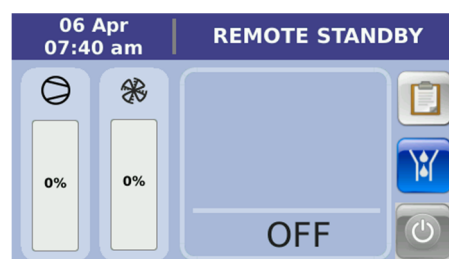
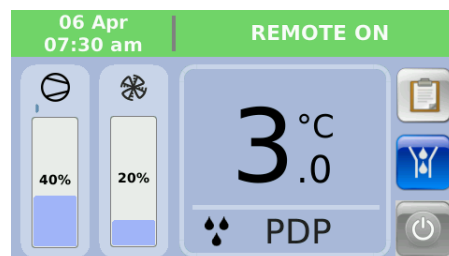
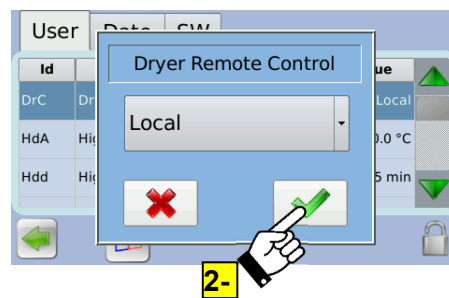

11.15.13 How the RS485 serial communication port operates

DMC50 power module is provided with a data communication connection for remote dryer monitoring operations.

Contact the manufacturer for further information on using this application.

If the fieldbus is used, is mandatory to install a galvanic isolator between the DMC50 and the communication network, in order to guarantee the DMC50 safety.



11.15.14 Displaying / changing process user parameters

1- With the dryer stopped (STANDBY) or operating (ON mode), press the  button to access the dryer's menu of functions.

2- Press the  button to display the list of process user parameters and respective current settings.



3- Scroll through the list of parameters using the   buttons.

4- Touch the screen on the parameter to be changed to display the possible settings (see user parameter table), then select one of the settings. If the parameter to be changed requires a numerical value, set the new value using the numerical keypad within the max and min limits shown.

5- Confirm the setting or numerical value entered using the  button or press the  button to return to the parameter list without making any changes. Repeat operations 3- 4- 5- for all parameters to be changed.

6- Press the  button to return to the previous screen at any time.

7- Press the SW tab to show the firmware version of DMC50 electronic control unit. All other functions included in the SW tab screen are password protected and they do not contain user functions.



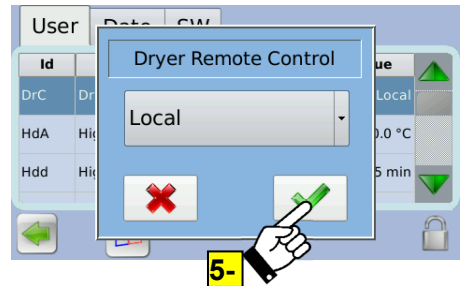
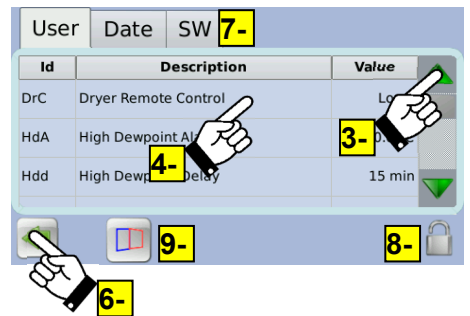
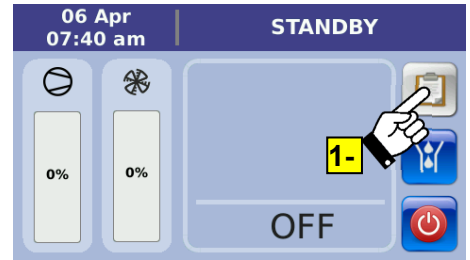

8-, 9- Buttons   are reserved for technical/diagnostic password-protected operations. They do not contain user functions.



ID	Description	Limits	Scale	Factory setting
DrC	- Dryer Remote Control - Enables/disables dryer remote control	Local / Remote	-	Local
HdA	- High Dewpoint Alarm - Sets the service warning intervention threshold high dew point	0...25.0°C or 32...77°F	0.5°C or 1°F	20.0°C or 68°F
Hdd	- High Dewpoint Delay - Sets the service warning delay time high dew point	1...20 minutes	1 minute	15 minutes
HdS	- High Dewpoint Alarm Stop - Select if high dew point service warning - Stops the dryer (Yes) - Does not stop the dryer (No)	Yes / No	-	No
SrV	- Service Setting - Sets the hours remaining till the next service NOTA : 00.0 = counter disabled	12.0 (x1000) hours	0.5 (x1000) hours	8.0 (x1000) hours
SCL	- Scale - Sets the temperature/pressure units of measurement °C = Temperature in °C and pressure in bar °F = Temperature in °F and pressure in psi	°C / °F	-	°C
AS	- Auto Restart - Enables/disables automatic dryer restart after restoring the electricity supply. Yes = the dryer restarts automatically after restoring the electricity supply (if it had been started) No = The dryer must be restarted using the  button.	Yes / No	-	No
Ard	- Auto Reset Service Warning Drain - Enables/disables the electronic condensation drain fault to be reset automatically. Yes = reset automatically No = reset manually	Yes / No	-	Yes
ACM	- Alarm Contact Management - Selects the switching logic for the alarm contact on the DCM50 control unit's controller module: 1 = any alarm and high dew point 2 = any alarm and any service warning 3 = any alarm	1...3	1	1
IPA	- IP Address - Selects the IP address to use in the serial connection line	1...255	1	1



Technical description

11.15.15 Changing the system date / time

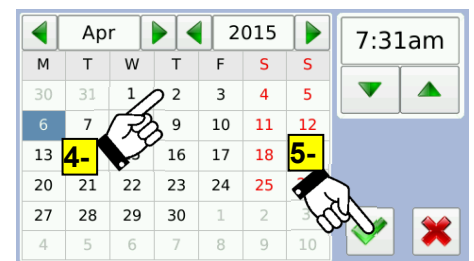
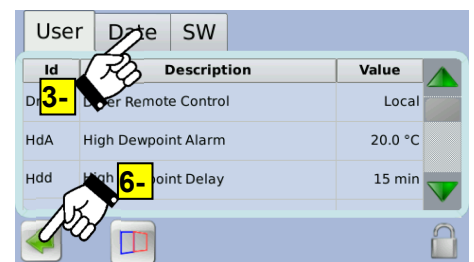
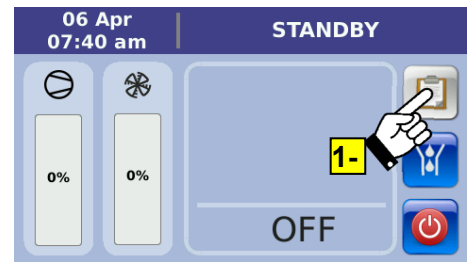
- 1- With the dryer stopped (STANDBY) or operating (ON mode), press the  button to access the dryer's menu of functions.
- 2- Press the  button to display the list of process user parameters and respective current settings.
- 3- Touch the Date tab on the screen.
- 4- Set the current date and time.
- 5- Confirm using the  button or press the  button to return to the parameter list without making any changes.
- 6- Press the  button to return to the previous screen at any time.



11.15.16 Changing the user interface language

- 1- With the dryer stopped (STANDBY) or operating (ON mode), press the  button to access the dryer's menu of functions.
- 2- Press the  button to display the list of available languages.
- 3- Choose the required language.
- 4- Press the  button to return to the previous screen at any time.

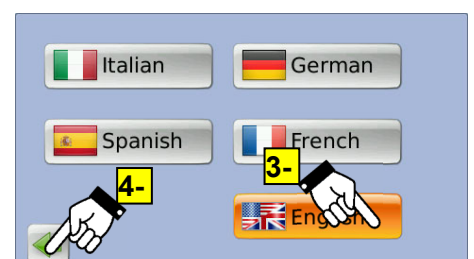
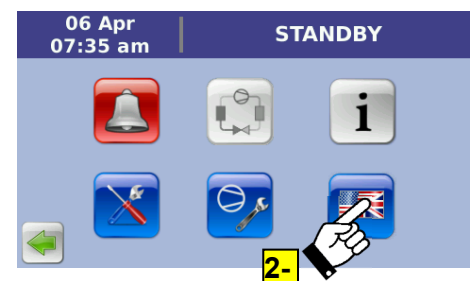
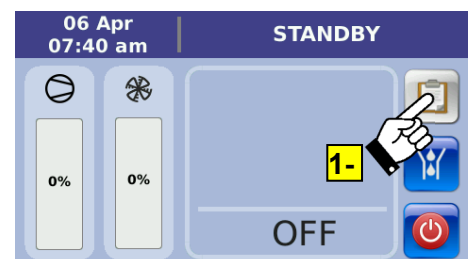

11.16 Electronically level-controlled BEKOMAT condensate drain

The electronically level-controlled BEKOMAT condensate drain is provided with a special condensate management which ensures that condensate is discharged safely and without an unnecessary loss of compressed air. This drain has a condensate collection container in which a capacitive sensor continuously monitors the liquid level. As soon as the switching level is reached, the capacitive sensor transmits a signal to the electronic control and a membrane solenoid valve opens to discharge the condensate. The BEKOMAT closes before compressed air emerges.

**Note!**

These BEKOMAT condensate drains were designed in particular for the operation in a **DRYPOINT RA eco** refrigeration dryer. The installation in other compressed-air processing systems or the replacement with another drain brand can lead to malfunction. The maximum operating pressure (see name plate) must not be exceeded!

Ensure that the upstream valve is open when the dryer starts operation.

To obtain detailed information regarding drain functions, troubleshooting, maintenance and spare parts, please read the installation and operating instructions of the BEKOMAT condensate drain.

12 Maintenance, troubleshooting, spare parts and dismantling

12.1 Checks and maintenance



Certified skilled personnel

Installation works must exclusively be carried out by authorised and qualified skilled personnel. Prior to undertaking any measures on the DRYPOINT® RA 1300-4400 eco compressed-air refrigeration dryer, the certified skilled personnel⁴ shall read up on the device by carefully studying the operating instructions. The operator is responsible for the adherence to these provisions. The respective directives in force apply to the qualification and expertise of the certified skilled personnel.

For safe operation, the device must only be installed and operated in accordance with the indications in the operating instructions. In addition, the national and operational statutory provisions and safety regulations, as well as the accident prevention regulations required for the respective case of application, need to be observed during employment. This applies accordingly when accessories are used



Danger!

Compressed air!

Risk of serious injury or death through contact with quickly or suddenly escaping compressed air or through bursting and/or unsecured plant components.

Compressed air is a highly dangerous energy source.

Never work on the dryer when the system is under pressure.

Never direct the compressed-air outlet or condensate drain hoses at persons.

The user is responsible for the proper maintenance of the dryer. Non-observance of the instructions in the "Installation" and "Maintenance, troubleshooting, spare parts and dismantling" chapters leads to the expiration of the guarantee. Improper maintenance may result in dangerous situations for the personnel and/or the device.



Danger!

Supply voltage!

Contact with non-insulated parts carrying supply voltage involves the risk of an electric shock resulting in injuries and death.

Only qualified and skilled personnel are authorised to run electrically-operated devices. Prior to undertaking maintenance measures at the device, the following requirements must be met:

Make sure that the power supply is switched off and that the device is off and marked for maintenance measures. Please also ensure that the power supply cannot be re-established during the works.



Prior to carrying out maintenance works at the dryer, switch it off main switch (control panel pos.1) and wait for at least 30 minutes.



Caution!

Hot surfaces!

During operation, several components can reach surface temperatures of more than +60°C. There is the risk of burns.

All components concerned are installed inside of the closed housing. The housing must only be opened by certified skilled personnel.

Some components can reach high temperatures during operation. Avoid any contact until the system or the component has cooled down.



DAILY:

- Check whether the dew point indicated on the electronics is correct.
- Ensure that the condensate drain system functions properly.
- Make sure that the condenser is clean.

⁴ Certified skilled personnel are persons who are authorised by the manufacturer, with experience and technical training, who are well-grounded in the respective provisions and laws and capable of carrying out the required works and of identifying and avoiding any risks during the machine transport, installation, operation and maintenance. Qualified and authorised operators are persons who are instructed by the manufacturer regarding the handling of the refrigeration system, with experience and technical training, and who are well-grounded in the respective provisions and laws.

EVERY 200 HOURS OR MONTHLY



- Clean the condenser using an air jet (max. 2 bar / 30 psig) inside out. Make sure not to damage the aluminium lamellae of the cooling package.
- Remove the filter of the electrical panel and clean the filter material with a jet of compressed air. If necessary replace the filter material
- Finally, verify the operation of the device.

EVERY 1,000 HOURS OR ANNUALLY



- Verify all screws, clamps and connections of the electric system to make sure that they are fastened securely. Check the device for broken and ruptured cables or cables without insulation.
- Check the refrigeration cycle for signs of oil and refrigerant leaks.
- Measure the current strength and note it down. Ensure that the read values are within the permissible limit values, as indicated in the specification table.
- Check the hose lines of the condensate drain and replace them, if required.
- Finally, verify the operation of the device.

EVERY 8,000 HOURS



- Replace BEKOMAT(S) Service Unit(s)

12.2 Troubleshooting



Certified skilled personnel

Installation works must exclusively be carried out by authorised and qualified skilled personnel. Prior to undertaking any measures on the DRYPOINT® RA 1300-4400 eco compressed-air refrigeration dryer, the certified skilled personnel shall read up on the device by carefully studying the operating instructions. The operator is responsible for the adherence to these provisions. The respective directives in force apply to the qualification and expertise of the certified skilled personnel.

For safe operation, the device must only be installed and operated in accordance with the indications in the operating instructions. In addition, the national and operational statutory provisions and safety regulations, as well as the accident prevention regulations required for the respective case of application, need to be observed during employment. This applies accordingly when accessories are used.



Danger!

Compressed air!

Risk of serious injury or death through contact with quickly or suddenly escaping compressed air or through bursting and/or unsecured plant components.

Compressed air is a highly dangerous energy source.

Never work on the dryer when the system is under pressure.

Never direct the compressed-air outlet or condensate drain hoses at persons.

The user is responsible for the proper maintenance of the dryer. Non-observance of the instructions in the "Installation" and "Maintenance, troubleshooting, spare parts and dismantling" chapters leads to the expiration of the guarantee. Improper maintenance may result in dangerous situations for the personnel and/or the device.



Danger!

Supply voltage!

Contact with non-insulated parts carrying supply voltage involves the risk of an electric shock resulting in injuries and death.

Only qualified and skilled personnel are authorised to run electrically-operated devices. Prior to undertaking maintenance measures at the device, the following requirements must be met:

Make sure that the power supply is switched off and that the device is off and marked for maintenance measures. Please also ensure that the power supply cannot be re-established during the works.



Prior to carrying out maintenance works at the dryer, switch it off main switch (control panel pos.1) and wait for at least 30 minutes.



Caution!

Hot surfaces!

During operation, several components can reach surface temperatures of more than +60°C. There is the risk of burns.

Maintenance, troubleshooting, spare parts and dismantling

All components concerned are installed inside of the closed housing. The housing must only be opened by certified skilled personnel.

Some components can reach high temperatures during operation. Avoid any contact until the system or the component has cooled down.

SYMPTOM	POSSIBLE CAUSE – SUGGESTED ACTION
◆ The dryer does not start.	<ul style="list-style-type: none">⇒ Check the power supply.⇒ Check the electric cabling.⇒ Fuse breakdown (see FU1/FU2/FU3 in the electric diagram) in the auxiliary circuit – replace it and check the proper operation of the dryer.⇒ Verify that dryer is in local mode.⇒ Electronic controller DMC50 in alarm condition – see the corresponding point.
◆ The refrigerating compressor does not work.	<ul style="list-style-type: none">⇒ The Dew Point displayed on DMC50 is sufficiently low, so the compressor is not active – wait that the temperature becomes higher⇒ Verify the electric wiring.⇒ Electronic controller DMC50 in alarm condition – see the corresponding point.⇒ Check that the compressor contactor (KC1) and/or circuit breaker (QC1) properly work.⇒ If the compressor still doesn't work, replace it and/or its variable speed drive.
◆ Condenser's fan doesn't work properly (Air-Cooled).	<ul style="list-style-type: none">⇒ The condensing pressure (HP) measured is sufficiently low, so the fan is not active – wait that the condensing pressure becomes higher.⇒ Verify the electric wiring.⇒ Electronic controller DMC50 in alarm condition – see the corresponding point.⇒ If the fan still doesn't work, replace it and/or its variable speed drive.⇒ Condensing pressure measured with DMC50 and BHP pressure transducer is not correct. Contact a refrigeration engineer to verify and compare the correct condensing pressure value. If required replace BHP pressure transducer and/or DMC50 controller.
◆ Dew point too high	<ul style="list-style-type: none">⇒ The dryer doesn't start - see specific point.⇒ The DewPoint probe doesn't correctly detect the temperature - ensure the sensor is pushed into the bottom of probe well.⇒ Failure temperature probe BT1 – check the electrical cabling and/or replace the probe.⇒ The Compressor doesn't work - see specific point.⇒ The ambient temperature is too high or the room aeration is insufficient - provide proper ventilation (Air-Cooled).⇒ The inlet air is too hot - restore nominal conditions.⇒ The inlet air pressure is too low - restore nominal conditions.⇒ The inlet air flow rate is higher than the rate of the dryer - reduce the flow rate - restore nominal conditions.⇒ The condenser is dirty - clean it (Air-Cooled)⇒ The condenser fan doesn't work - see specific point (Air-Cooled).⇒ The cooling water is too hot - restore nominal conditions (Water-Cooled).⇒ The cooling water flow is insufficient - restore nominal conditions (Water-Cooled).⇒ The dryer doesn't drain the condensate - see specific point.⇒ There is a leak in the refrigerant circuit - contact a refrigeration engineer. In case of refrigerant leak, dewpoint could be high, compressor runs at low speed and does not stop even at no load and low ambient, BT3 (refrigerant compressor suction) temperature is high and condensing pressure is low.⇒ Evaporating pressure measured with DMC50 and BLP pressure transducer is not correct. Contact a refrigeration engineer to verify and compare the correct evaporating pressure value. If required replace BLP pressure transducer and/or DMC50 controller.⇒ One or more Electronic Expansion Valve EEV doesn't work properly - see specific point.

◆ Dew point too low.	<p>NOTE: Slightly negative DewPoint peaks are normal with low loads and refrigerant compressor cycling ON/OFF</p> <p>⇒ The fan is always on – verify the correct operation pressure transducer (see BHP on the electric diagram) – (Air-Cooled).</p> <p>⇒ Ambient temperature is too low - restore nominal conditions (Air-Cooled).</p> <p>⇒ Evaporating pressure measured with DMC50 and BLP pressure transducer is not correct. Contact a refrigeration engineer to verify and compare the correct evaporating pressure value. If required replace BLP pressure transducer and/or DMC50 controller</p> <p>⇒ The DewPoint probe doesn't correctly detect the temperature - ensure the sensor is pushed into the bottom of probe well.</p>
◆ Extreme pressure drop in the dryer.	<p>⇒ The dryer doesn't drain the condensate - see specific point.</p> <p>⇒ The DewPoint is too low - the condensate is frost and blocks the air - see specific point.</p> <p>⇒ Check for throttling the flexible connection hoses.</p> <p>⇒ Check heat exchanger cleaning and prefilter installation.</p>
◆ The dryer does not drain the condensate.	<p>⇒ The condensate drain service valve is closed - open it.</p> <p>⇒ Verify the electric wiring.</p> <p>⇒ The DewPoint is too low - the condensate is frost and blocks the air - see specific point.</p> <p>⇒ Inlet compressed air pressure is too low and condensate is not drained – restore nominal conditions.</p> <p>⇒ BEKOMAT-discharge unit does not work properly (see BEKOMAT manual).</p>
◆ The dryer continuously discharges condensate.	<p>⇒ BEKOMAT discharge unit is dirty (see BEKOMAT manual).</p>
◆ Water within the line.	<p>⇒ Verify that the air inlet and outlet connections are correctly connected to the compressed air system (not reversed connection).</p> <p>⇒ The dryer doesn't start - see specific point.</p> <p>⇒ If installed - Untreated air flows through the by-pass unit - close the by-pass.</p> <p>⇒ The dryer doesn't drain the condensate - see specific point.</p> <p>⇒ DewPoint too high - see specific point.</p>
◆ HPS high pressure switch has been activated.	<p>⇒ Check which of the following has caused the activation:</p> <ol style="list-style-type: none"> 1. The ambient temperature is too high or the room aeration is insufficient - provide proper ventilation (Air-Cooled). 2. The condenser is dirty - clean it (Air-Cooled). 3. Check HPS electrical wiring. 4. The condenser fan doesn't work - see specific point (Air-Cooled). 5. The cooling water is too hot - restore nominal conditions (Water-Cooled). 6. The cooling water flow is insufficient - restore nominal conditions (Water-Cooled). <p>⇒ Reset the pressure switch pressing the button on the controller itself - verify the dryer for correct operation.</p> <p>⇒ Condensing pressure measured with DMC50 and BHP pressure transducer is not correct. Contact a refrigeration engineer to verify and compare the correct condensing pressure value. If required replace BHP pressure transducer and/or DMC50 controller</p> <p>⇒ HPS pressure switch is faulty - contact a refrigeration engineer to replace it.</p>
◆ LPS low pressure switch has been activated.	<p>⇒ Check LPS electrical wiring.</p> <p>⇒ There is a leak in the refrigerating fluid circuit - contact a refrigeration engineer.</p> <p>⇒ The pressure switch reset automatically when normal conditions are restored - check the proper operation of the dryer.</p> <p>⇒ Evaporating pressure measured with DMC50 and BLP pressure transducer is not correct. Contact a refrigeration engineer to verify and compare the correct evaporating pressure value. If required replace BLP pressure transducer and/or DMC50 controller.</p>
◆ Compressor discharge temperature too high.	<p>⇒ Check which of the following has caused the failure:</p> <ol style="list-style-type: none"> 1. Excessive thermal load – restore nominal conditions. 2. The inlet air is too hot - restore nominal conditions. 3. The ambient temperature is too high or the room aeration is insufficient - provide proper ventilation (Air-Cooled). 4. The condenser unit is dirty - clean it (Air-Cooled). 5. The fan doesn't work - see specific point (Air-Cooled). 6. Refrigerant gas leak - contact a refrigeration engineer. 7. One or more Electronic Expansion Valve EEV doesn't work properly - see specific point.
◆ Condensing pressure too high	<p>⇒ Check which of the following has caused the failure:</p> <ol style="list-style-type: none"> 1. The ambient temperature is too high or the room aeration is insufficient - provide proper ventilation (Air-Cooled). 2. The condenser unit is dirty - clean it (Air-Cooled). 3. Failure refrigerant pressure transducer BHP – verify condensing pressure (HP) measure from BHP (value available on DMC 50 display) with a pressure gauge and if they doesn't match replace the transducer. 4. The fan doesn't work properly - does not achieve the full speed- see specific point (Air-Cooled). 5. The temperature of the cooling water is too hot – restore nominal conditions (Water-Cooled). 6. Cooling water flow is not sufficient – restore nominal conditions (Water-Cooled).

- | | |
|--|--|
| ◆ Condensing pressure too low | ⇒ Check which of the following has caused the failure: <ol style="list-style-type: none">1. Ambient temperature is too low - restore nominal conditions (Air-Cooled).2. Air flows through the condenser even with fan off – protect dryer against wind or external air flows (not caused by dryer's fan) (Air-Cooled).3. The temperature of the cooling water is too low – restore nominal conditions (Water-Cooled).4. The cooling water flow adjusting valve requires re-adjusting - contact a specialized technician to restore nominal setting (Water-Cooled).5. Failure refrigerant pressure transducer BHP – verify condensing pressure (HP) measure from BHP (value available on DMC 50 display) with a pressure gauge and if they doesn't match replace the transducer.6. Refrigerant gas leak - contact a refrigeration engineer.7. The fan doesn't work properly - it runs at speed too high - see specific point (Air-Cooled).8. Compressor does not work – see specific point. <hr/> |
| ◆ Evaporating pressure too high | ⇒ Find out the reason for the fault: <ol style="list-style-type: none">1. Excessive thermal load – re-establish the nominal conditions.2. The inlet air is too hot – re-establish the nominal conditions.3. The ambient air temperature is too high or the room ventilation insufficient – ensure sufficient ventilation.4. The condenser is dirty – please clean it (air-cooled).5. The fan does not work – see the corresponding section (air-cooled).6. Check by-pass solenoid valve proper functioning.7. The adjusting valve for the cooling-water flow needs to be re-adjusted - contact a specialist to have the nominal calibration re-established (water-cooled).8. Evaporating pressure measured with DMC50 and BLP pressure transducer is not correct. Contact a refrigeration engineer to verify and compare the correct evaporating pressure value. If required replace BLP pressure transducer and/or DMC50 controller9. One or more Electronic Expansion Valve EEV doesn't work properly - see specific point.10. Compressor does not work – see specific point. <hr/> |
| ◆ Low differential pressure between HP-LP values | ⇒ Find out the reason for the fault: <ol style="list-style-type: none">1. The fan doesn't work properly - it runs at speed too high - see specific point (Air-Cooled).2. The ambient temperature is too low – re-establish the nominal conditions.3. Air flows through the condenser although the fan is switched off – protect the dryer against wind or external air flows (not caused by the fan of the dryer) - (air-cooled).4. The cooling-water temperature is too low – re-establish the nominal conditions (water-cooled).5. The adjusting valve for the cooling-water flow needs to be re-adjusted - contact a technician for refrigeration plants to have the nominal calibration re-established (water-cooled).6. Check by-pass solenoid valve proper functioning.7. Evaporating pressure measured with DMC50 and BLP pressure transducer is not correct. Contact a refrigeration engineer to verify and compare the correct evaporating pressure value. If required replace BLP pressure transducer and/or DMC50 controller8. Condensing pressure measured with DMC50 and BHP pressure transducer is not correct. Contact a refrigeration engineer to verify and compare the correct condensing pressure value. If required replace BHP pressure transducer and/or DMC50 controller9. Refrigerant gas leak – contact a technician for refrigeration plants.10. Compressor does not work – see specific point. <hr/> |

- ◆ Electronic controller DMC50 in alarm condition (status area red colour) - See section 11.15.6
- ⇒ Status area blinking red: one or more alarms are active. The display shows the ID code and the description of the active alarm.
 - ⇒ Status area steady red: one or more alarms need to be reset. The display shows the ID code and the description of alarm which is no longer active but which still need to be reset.
 - ⇒ Alarms are shown by following codes and descriptions:
 1. **Pressure Switches** - HPS pressure switch triggered (refrigerant high pressure) because the refrigerant pressure is too high – see the specific point. Or LPS pressure switch triggered (low pressure) because the refrigerant pressure is too low – see the specific point.
 2. **Expansion Valve** – One or more Electronic Expansion Valve EEV doesn't work properly – see the specific point.
 3. **Fan protection (air-cooled)** - At least one of electrical protections of the fan has triggered or the variable speed drive is in alarm condition or fault - see electric diagram.
 - Circuit breaker QV1 has tripped - reset circuit breaker, restart and check the perfect functioning of the dryer.
 - Variable speed drive INV2 in alarm condition – For complete information refer to the manual of the condenser fan drive. To reset the alarm conditions, switch off the dryer main switch (Control panel pos.1) wait at least 60 seconds, and then restore the power.
 If one or more alarms are active, the condenser fan drive's display will show active alarm code number.
 To reset the alarm, press the [Reset] button on the fan variable speed drive, the alarm LED will switch off.
 Fan variable speed drive has an internal alarm log accessible from the drive display as per following procedure:
 Push "Menù" button two times
 Push "UP" or "DOWN" button until display shows "15-__" and push "OK" button
 Push "UP" or "DOWN" button until display shows "15-30" and push "OK" button
 The latest alarms are logged and displayed with their alarm code.
 The total alarm logged are 10, starting with number 0 to 9.
 Alarm code and description:
 - 2 – Fault in condenser fan drive, replace the driver.
 - 4 – Mains phase loss – Missing phase on supply side, or too high voltage imbalance.
Check supply voltage.
 - 7 – DC over voltage – Intermediate circuit voltage exceeds limit.
Check static or transient overvoltages in the input power supply. Restore it in the proper operating limits.
 - 8 – DC under voltage – Intermediate circuit voltage drops below "voltage warning low" limit.
Check and correct:
 - missing phase in input power supply
 - blown fuse
 - undervoltage on mains
 - 9 – Fan driver overloaded – More than 100% load for too long time.
Check and correct:
 - ambient temperature is too high - restore nominal conditions.
 - condenser cleaning or any obstruction to fan ventilation (condenser fan canalization not admitted)
 - fan motor current adsorption is higher than nominal – check proper fan motor functioning
 - 10 – Motor ETR over temperature – Motor is too hot due to more than 100% load for too long time.
Wait 30 minutes, restart and check the perfect functioning of the dryer.
 - 11 – Motor thermistor over temperature – Thermistor or thermistor connection is disconnected.
Check and correct fan motor internal thermal protection(s) and their connection to the fan driver. Wait 30 minutes, restart and check the perfect functioning of the dryer.
 - 12 – Fault in condenser fan drive, replace the driver.
 - 13 – Over current – Output current limit is exceeded.
Check and correct:
 - fan cable or connections.
 - low input voltage to fan driver.
 - faulty fan.
 - 14 – Earth fault – Discharge from output phases to ground.
Check and correct ground fault on motor or motor-to- fan driver cables.
 - 16 – Short Circuit – Short circuit in motor or on motor terminals/connections.
Check and correct short circuit on motor or motor-to- fan driver cables.
 - 17 – Fault in condenser fan drive, replace the driver.
 - 25 – Fault in condenser fan drive, replace the driver.

- 27 – Fault in condenser fan drive, replace the driver.
- 28 – Fault in condenser fan drive, replace the driver.
- 29 – Power board over temp – Heatsink cut-out temperature has been reached.
Check and correct:
 - ambient temperature is too high - restore nominal conditions (Air-Cooled).
 - obstruction in the fan driver cooling air flow.
 - dirt or dust coating in the fan driver heat sink.
 - excessive fan motor load.
 - fan driver cooling fan failure – replace the fan driver.
 - electrical box cooling fan failure – replace the electrical box cooling fan.
- 30 – Motor phase U missing – Motor phase U is missing. Check the phase.
- 31 – Motor phase V missing – Motor phase V is missing. Check the phase.
- 32 – Motor phase W missing – Motor phase W is missing. Check the phase.
- 38 – Fault in condenser fan drive, replace the driver.
- 44 – Earth fault – Discharge from output phases to ground.
Check and correct ground fault on motor or motor-to-fan driver cables.
- 47 – Control Voltage Fault – 24 V DC may be overloaded. Check the fan driver 24 V DC output cables.
- 51 – Fault in condenser fan drive, replace the driver.
- 52 – Fault in condenser fan drive, replace the driver.
- 63 – Fault in condenser fan drive, replace the driver.
- 80 – Fault in condenser fan drive, replace the driver.

Note : “error 85” can appear trying to access a locked fan driver function pushing a display button. This error isn’t related to a condenser fan drive malfunction.

Fault variable speed drive INV2 - Replace the variable speed drive.

- 4. **High Discharge Temperature** - The outlet temperature protection of the compressor has triggered as a result of a very high temperature, over safety limits (probe T4) – see the specific point.
- 5. **Compressor protection** - The electrical protection of the compressor has tripped (see QC1 on the electric diagram) – reset, restart and check the perfect functioning of the dryer.
- 6. **Ice**: The temperature inside the exchanger (probe BT1) is too low – the dew point is too low – see the specific point.
Note: is the only alarm which is displayed and automatically resets with the dryer stopped (STANDBY).
- 7. **Probe Fault LP** - Failure pressure transducer BLP - see electric diagram - check the electric cabling and/or replace the transducer.
- 8. **Probe Fault HP** - Failure pressure transducer BHP - see electric diagram - check the electric cabling and/or replace the transducer.
- 9. **Probe Fault T1** - Failure temperature probe BT1 - see electric diagram - check the electric cabling and/or replace the probe.
- 10. **Probe Fault T4** - Failure temperature probe BT4 - see electric diagram - check the electric cabling and/or replace the probe.
- 11. **Low Differential Pressure** - Low differential pressure between HP-LP values - see the corresponding paragraph.
- 12. **High Evaporating Pressure** - The evaporating pressure is too high – see the corresponding paragraph.
- 13. **Low Condensing Pressure** - The condensing pressure is too low - see the corresponding paragraph
- 1001. **Power Unit Communication Fault** - Data communication between display and DMC50 power module is lost - Check the cable connection between two modules and / or replace the cable.
- 1002. **Variable speed drive Communication Fault** - Data communication between DMC50 power module and compressor variable speed drive is lost.
Variable speed drive INV 1 not powered - check that the compressor contactor (KC1) and/or circuit breaker (QC1) properly work/not triggered. Check proper variable speed drive wiring.
Cable data connection broken - Check the cable connection between the two modules and / or replace the cable.
DMC 50 power module failure – Replace the power module.
Fault variable speed drive INV1 - Replace the variable speed drive.

169001 → 169118 **Variable speed drive INV1 in alarm condition** – For complete information refer to the manual of the refrigerant compressor driver. To reset the alarm conditions, switch off the

dryer main switch (Control panel pos.1) wait at least 60 seconds, and then restore the power. If one or more alarms are active, the compressor drive's display will show active alarm code number.

To reset the alarm, press the [Reset] button on the fan variable speed drive, the alarm LED will switch off.

169001. Pwr.Card Temp - FC 101 fault number: 69 – The temperature sensor on the power card exceeds the upper or lower limits.
Check and correct:
- Ambient temperature is too high or too low - restore nominal conditions.
 - Obstruction in the compressor driver cooling air flow.
 - Dirt or dust coating in the compressor driver heat sink.
 - Excessive compressor load.
 - Compressor driver cooling fan failure – replace the compressor driver.
 - Check electrical box filter cleaning.
 - Electrical box cooling fan failure – replace the electrical box cooling fan.
169002. Earth Fault – FC 101 fault number: 14 – Discharge from output phases to ground.
Check and correct ground fault on motor or motor-to-compressor driver cables
169004. Fault in compressor variable speed drive, replace the driver.
169005. Over Current – FC 101 fault number: 13– Output current limit is exceeded.
Check and correct:
- Compressor cable or connections.
 - Low input voltage to compressor driver.
 - Faulty compressor.
169008. Fault in compressor variable speed drive, replace the driver.
169009. Inverter overld. - FC 101 fault number: 9 – More than 100% load for a long time.
Check and correct:
- Excessive dryer thermal load – restore nominal conditions.
 - Compressor motor current adsorption is higher than nominal – check proper compressor motor functioning.
169010. DC under Volt - FC 101 fault number: 8 – Intermediate circuit voltage drops below “voltage warning low” limit.
Check and correct:
- missing phase in input power supply.
 - blown fuse.
 - undervoltage on mains.
169011. DC over Volt - FC 101 fault number: 7 – Intermediate circuit voltage exceeds the limit.
Check static or transient overvoltages in the input power supply. Restore it in the proper operating limits.
169012. Short Circuit - FC 101 fault number: 16 – Short-circuit in motor or on motor terminals/connections.
Check and correct short circuit on motor or motor-to-compressor driver cables.
169014. Mains ph. loss - FC 101 fault number: 4 – Missing phase on the supply side or too high voltage imbalance.
Check the supply voltage.
169015. Fault in compressor variable speed drive, replace the driver.
169016. Fault in compressor variable speed drive, replace the driver.
169017. Fault in compressor variable speed drive, replace the driver.
169019. U phase Loss - FC 101 fault number: 30 – Motor phase U is missing. Check phase.
169020. V phase Loss - FC 101 fault number: 31 – Motor phase V is missing. Check phase.
169021. W phase Loss - FC 101 fault number: 32 – Motor phase W is missing. Check phase.
169023. 24 V supply low - FC 101 fault number: 47 – 24 V DC may be overloaded. Check the compressor driver 24 V DC output cables.
169028. Earth fault - FC 101 fault number: 44 – Discharge from output phases to ground.
Check and correct ground fault on motor or motor-to-compressor driver cables.
169029. Fault in compressor variable speed drive, replace the driver.
169100. Fault in compressor variable speed drive, replace the driver.
169104. Fault in compressor variable speed drive, replace the driver.
169108. Fault in compressor variable speed drive, replace the driver.
169112. Fault in compressor variable speed drive, replace the driver.
169118. Fault in compressor variable speed drive, replace the driver.
-

Maintenance, troubleshooting, spare parts and dismantling

- ◆ Electronic controller DMC50 in service warning condition (status area orange colour) - See section 11.15.5
- ⇒ Status area blinking orange : one or more service warnings are active. The display shows the ID code and the description of the active warning.
- ⇒ Status area steady orange : one or more service warnings need to be reset. The display shows the ID code and the description of warning which is no longer active but which still need to be reset
- ⇒ Service warnings are shown by following codes and descriptions :
15. **Low Dew Point** - Dew point too low – see the corresponding paragraph.
 16. **High Dew Point** - Dew point too high (higher than adjusted value on HdA parameter) – see the corresponding paragraph.
 17. **Probe Fault T2** - Failure temperature probe BT2 - see electric diagram - check the electric cabling and/or replace the probe.
 18. **Probe Fault T3** - Failure temperature probe BT3 - see electric diagram - check the electric cabling and/or replace the probe.
 19. **Drainer** - The condensate drain ELD (and/or ELD2 if installed) does not work properly (ALARM contact is open) – see electric diagram and corresponding paragraph.
 20. **Programmed service** - Maintenance notification time is expired (over than adjusted value on SrV parameter) – carry out the scheduled maintenance and reset the hour meter.
 21. **High discharge temperature** - The outlet temperature protection of the compressor has triggered as a result of a very high temperature but within safety limits (probe T4) – see the corresponding paragraph.
 22. **High Evaporating Pressure** - The evaporating pressure is too high – see the corresponding paragraph.
 23. **Low Condensing Pressure** - The condensing pressure is too low - see the corresponding paragraph.
 24. **High Condensing Pressure** - The condensing pressure is too high - see the corresponding paragraph.
- 169201 → 169318 **Variable speed drive INV1 in warning condition** – For complete information refer to the manual of the refrigerant compressor driver. Compressor variable speed drive warning disappear when abnormal condition is removed.
169201. Pwr.Card Temp - FC 101 fault number: 69 – The temperature sensor on the power card exceeds the upper or lower limits. See alarm “169001”
169204. Fault in compressor variable speed drive, replace the driver.
169205. Over Current - FC 101 fault number: 13 – Compressor variable speed drive peak current limit is exceeded. See alarm “169005”.
169208. Fault in compressor variable speed drive, replace the driver.
169209. Inverter overld. - FC 101 fault number: 9 – More than 100% load for a long time. See alarm “169009”.
169210. DC under Volt - FC 101 fault number: 8 – Intermediate circuit voltage drops below voltage warning low limit. See alarm “169010”.
169211. DC over Volt. - FC 101 fault number: 7 - Intermediate circuit voltage exceeds the limit. See alarm “169011”.
169214. Mains ph. loss - FC 101 fault number: 4 – Missing phase on the supply side or too high voltage imbalance. See alarm “169014”.
169216. Fault in compressor variable speed drive, replace the driver.
169223. 24 V Supply Low - FC 101 fault number: 47 – 24 V DC supply may be overloaded. See alarm “169023”.
169225. Current Limit - FC 101 fault number: 59 – The current exceeds the peak value.
Check and correct:
- Compressor cable or connections
- Low input voltage to compressor driver
169226. Low temp. - FC 101 fault number: 66 – Heat sink temperature too low.
Restore nominal conditions.
169308. Fault in compressor variable speed drive, replace the driver.
169315. Fault in compressor variable speed drive, replace the driver..
169318. Fans Warning - FC 101 fault number: 24 – Fault in compressor variable speed drive, replace the driver.
-

- ◆ Electronic Expansion Valve EEV doesn't work properly

Each dryer is equipped with a DRVD display (display for DRV available in the following picture) required for DRV troubleshooting.

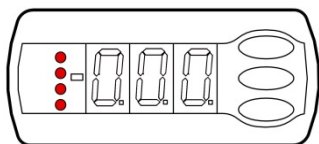

1. DRVD display

Connect the DRVD display to each DRV, one by one, in order to check which of the following has caused the activation:

1. DRVD display is not powered:
 - Verify the DRV(1...n) electric wiring power supply included.
 - Verify that all DRV connectors are properly tight.
 - Blow of fuse (see FU(4...n) according to dryer model) of DRV (EEV controller) power supply - Replace it and check the proper dryer operation.

2. DRVD display is powered and shows the four vertical led on the left part blinking.

This condition means that one or more alarms are active.

Press once the upper button and display will show one or more of the following alarm code:

E24 – Temperature sensor error – Failure temperature probe BS(1...n) - see electric diagram - check the electric cabling and/or replace the probe .

E20 – Pressure sensor error – Failure pressure transducer BP(1...n) - see electric diagram - check the electric cabling and/or replace the transducer.

A44 – Fault in controller – replace the DRV controller.

E1 – Fault in controller – replace the DRV controller.

A11 – Fault in controller – replace the DRV controller.

E19 – Fault in controller – replace the DRV controller.

E25 – Fault in controller – replace the DRV controller.

As soon as the problem is solved, the four led on the left of the display will be OFF (not blinking).

Verify that the actual evaporator refrigerant super-heating (in °K) shown by the DRV is matching with the effective super-heating of that evaporator.

NOTE! – Never restart the dryer with one or more DRV still in alarm (four led on the left of the display are blinking). Non-observance will cause damage.

3. DRVD display is powered and it is not in alarm (the four vertical led on the left part are not powered).

This condition means that the alarm contact on the DRV(1...n) was open but currently the DRV is not in alarm.

Press once the upper button, display shows “non” to confirm that no alarm is active.

- The relay KDA (1...n) is not powered - Check that all wires are properly connected and tight, verify that proper operation of the relay or replace it.
- Verify the DRV(1...n) electric wiring of (EEV controller).

Check that all DRV connectors are properly tight.

If the problem still persists, one or more DRV is defect – Find which one/s is defect and replace it/them.

12.3 Recommended spare parts

Spare parts list is printed on a dedicated sticker applied inside the dryer. On this sticker each spare part is identified with its ID Number and related Spare Part Number. Here below the cross reference table between ID Numbers and exploded drawings Ref. with their description and quantity installed in the dryers.

NOTE: To order the recommended spare parts or other elements, the data on the name plate must be indicated.

ID N.	DESCRIPTION	DRYPOINT® RA 1300-4400 eco						
		1300	1800	2200	2400	2900	3600	4400
1 - 1.1	Heat exchanger replacement kit	1	1	1	2	2	2	2
2	LPS Pressure switch	1	1	1	1	1	1	1
4	HPS Pressure switch	1	1	1	1	1	1	1
6	MC1 Compressor	1	1	1	1	1	1	1
6.1		Compressor crankcase heater	1	1	1	1	1	1
8	Condenser	1	1	1	2	2	2	2
9	MF1 Complete fan	1	1	1	2	2	2	2
10	Filter drier	1	1	1	1	1	1	1
12	BTn Temperature probe	4	4	4	4	4	4	4
19	Water regulating valve (water cooled only)	1	1	1	1	1	1	1
21	ELD BEKOMAT condensate drain	1	1	1	2	2	2	2
21.1		BEKOMAT service unit	1	1	1	2	2	2
35	EEVn Electronic expansion valve	1	1	1	2	2	2	2
35.1		Coil for electronic expansion valve	1	1	1	2	2	2
37	BHP Pressure transducer	1	1	1	1	1	1	1
39	BLP Pressure transducer	1	1	1	1	1	1	1
82	CHV Check valve	1	1	1	1	1	1	1
85	EVB Pressure balancing solenoid valve	1	1	1	1	1	1	1
85.1		Coil for pressure balancing solenoid valve	1	1	1	1	1	1
86	BSn EEV temperature probe	1	1	1	2	2	2	2
87	BPn EEV pressure transducer	1	1	1	2	2	2	2
60	QS Main switch	1	1	1	1	1	1	1
	A1 DMC50 power module	1	1	1	1	1	1	1
	A2 DMC50 display	1	1	1	1	1	1	1
	A1.1 DMC50 power cable - power module to display	1	1	1	1	1	1	1
	A1.2 DMC50 data cable - power module to display	1	1	1	1	1	1	1
	A1.3 DMC50 data cable - power module to compressor driver	1	1	1	1	1	1	1
	INV1 Compressor variable speed drive	1	1	1	1	1	1	1
	INV2 Condenser fan drive (air cooled only)	1	1	1	1	1	1	1
	INV2D Operating panel for INV2	1	1	1	1	1	1	1
	MCP Electrical panel fan	1	1	1	1	1	1	1
	DRVn EEV controller	1	1	1	2	2	2	2
	DRVD Operating panel for DRV	1	1	1	1	1	1	1
	QC1 Circuit breaker	1	1	1	1	1	1	1
	QV1		1	1	1	1	1	1
	FU Fuse kit	1	1	1	1	1	1	1
	KC1 Contactor	1	1	1	1	1	1	1
	KC1.1 Auxiliary contact	1	1	1	1	1	1	1
	KEN Relay	1	1	1	1	1	1	1
	KDR				1	1	1	1
	TF Transformer	1	1	1	1	1	1	1
HT Thermostat	1	1	1	1	1	1	1	

12.4 Maintenance works at the refrigeration cycle



Caution! Refrigerant!

Maintenance and repair works at refrigeration systems must only be carried out by BEKO service technicians in accordance with the local provisions.

The total amount of refrigerant in the system must be collected for recycling purposes, resource recovery or disposal.

The refrigerant must not be discharged into the environment.

When delivered, the dryer is ready to operate and filled with a refrigerant of the R134a or R407C type.



Should you detect a refrigerant leak, please contact a BEKO service technician. Prior to any intervention, the room needs to be ventilated.

When the refrigeration cycle needs to be refilled, please also contact a BEKO service technician.

You will find the refrigerant type and amount on the name plate of the dryer.

Properties of the refrigerant used:

Refrigerant	Chemical formula	MIK	GWP
R134a - HFC	CH ₂ FCF ₃	1000 ppm	1430
R407C - HFC	R32/125/134a (23/25/52) CHF ₂ CF ₃ /CH ₂ F ₂ /CH ₂ FCF ₃	1000 ppm	1773.85

12.5 Dismantling the dryer

When the dryer is dismantled, all parts and operating materials related to the plant need to be disposed of separately.



Component	Material
Refrigerant	R407C, R134a, oil
Roof and supports	Structural steel, epoxy paint coat
Refrigerating compressor	Steel, copper, aluminium, oil
Aluminium heat exchanger	Aluminium
Condenser unit	Aluminium, copper, structural steel
Pipe	Copper
Fan	Aluminium, copper, steel
Valve	Brass, steel
BEKOMAT condensate drain	PVC, aluminium, steel
Insulant	Synthetic rubber without CFCs, polystyrene, polyurethane
Electric cable	Copper, PVC
Electric parts	PVC, copper, brass



We recommend observing the safety provisions in force for the disposal of each material type.

The refrigerant contains lubricating-oil droplets which are released by the compressor.

The refrigerant must not be discharged into the environment. It must be sucked off from the dryer using a suitable device, and then needs to be supplied to a collection point.

13 Attachments

Exploded views – List of components

1	Alu-Dry module	42	Electrical panel fan
1.1	Insulation material	43	Oil separator
2	Refrigerant pressure switch LPS	44	Electrical panel filter
4	Refrigerant pressure switch HPS	51	Front panel
6	Compressor	52	Back panel
8	Condenser (Air-Cooled)	53	Right lateral panel
9	Condenser fan (Air-Cooled)	54	Left lateral panel
10	Filter dryer	55	Cover
12	BT1 temperature probe (dew point)	56	Base plate
13	Condensate drain service valve	57	Upper plate
17	Electronic instrument	58	Support beam
18	Condenser (Water-Cooled)	59	Support bracket
19	Condenser water-regulating valve (Water-Cooled)	60	Control panel
20	Refrigerant accumulator	65	Condenser filter
21	BEKOMAT	66	Control panel door
22	Main switch	67	Compressor suction strainer
34	Liquid sight glass	82	Check valve CHV
35	Electronic Expansion Valve EEV	83	Refrigerant service valve – H.P. side
36	Liquid separator	84	Refrigerant service valve – L.P. side
37	Refrigerant pressure transducer BHP	85	Pressure balancing solenoid valve EVB
39	Refrigerant pressure transducer BLP	86	EEV temperature sensor BS
40	Compressor variable speed drive INV1	87	EEV pressure transducer BP
41	Condenser fan variable speed drive INV2		

Electric diagrams – List of components

MC1	Compressor	LPS	Low pressure switch
RC	Compressor crankcase heater	EEV1-2	Electronic Expansion Valve
MF1-2	Condensers fans	BS1-2	EEV temperature sensor
A1	DMC50 – Power module	BP1-2	EEV pressure transduce
A2	DMC50 – Display module	DRV1-2	EEV controller
INV1	Compressor variable speed drive	ELD	BEKOMAT
INV2	Condenser fan drive	EVB	Pressure balancing solenoid valve
BT1-4	Temperature probes	QS	Main switch
BHP	Refrigerant High pressure transducer	HT	Electrical panel fan thermo switch
HPS	High pressure switch		
NT1	Air-Cooled only	NT5	Limit of equipment
NT2	Verify transformer connection according to power supply voltage	NT6	Timed drain output
NT3	Jump if not installed	NT7	Water Cooled only
NT4	Provided and wired by customer		
BN	Brown	OR	Orange
BU	Blue	RD	Red
BK	Black	WH	White
YG	Yellow / Green	WH / BK	White / Black

13.1 Dryers dimensions

13.1.1 DRYPOINT RA 1300-2200 eco

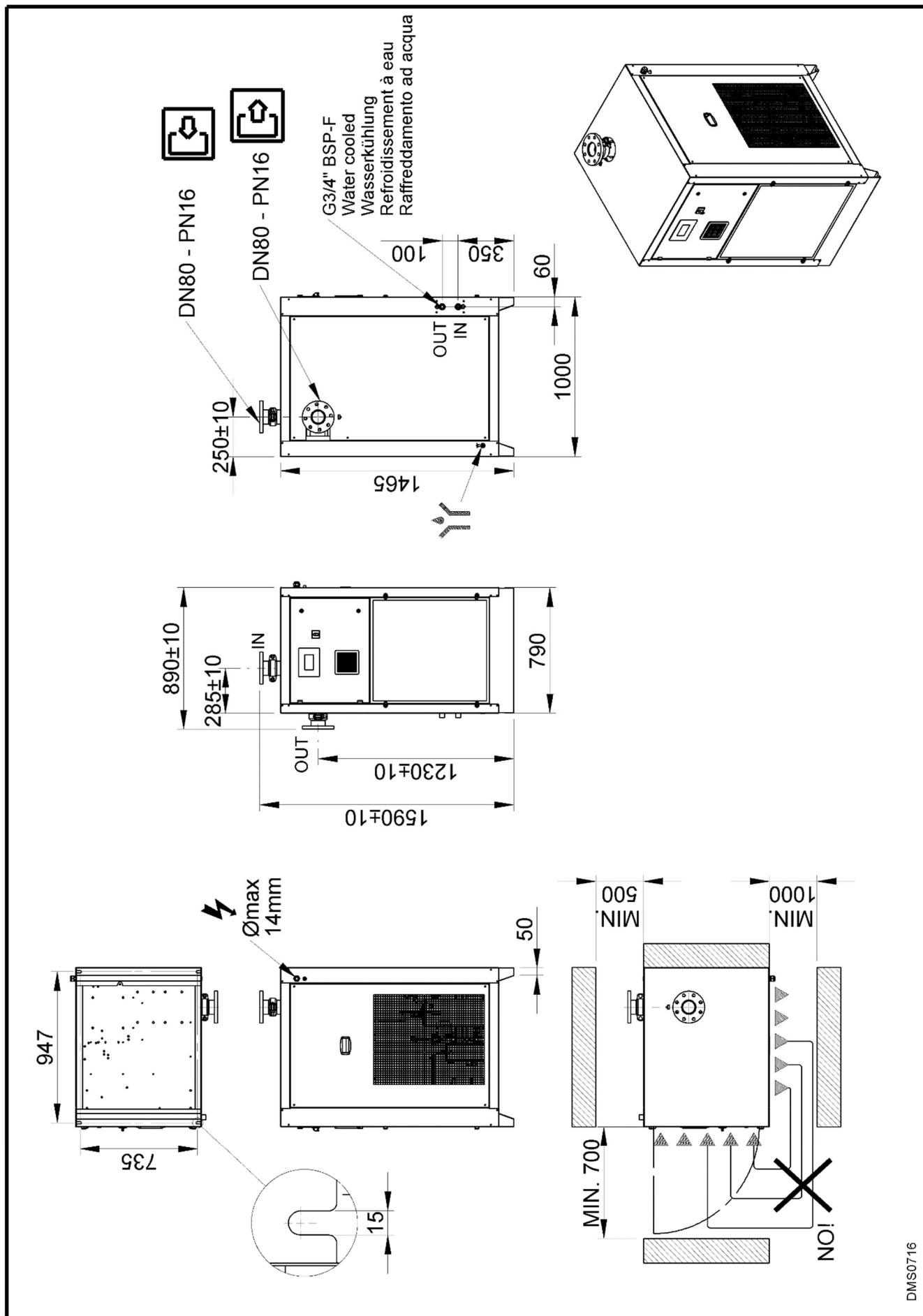

DMS0716

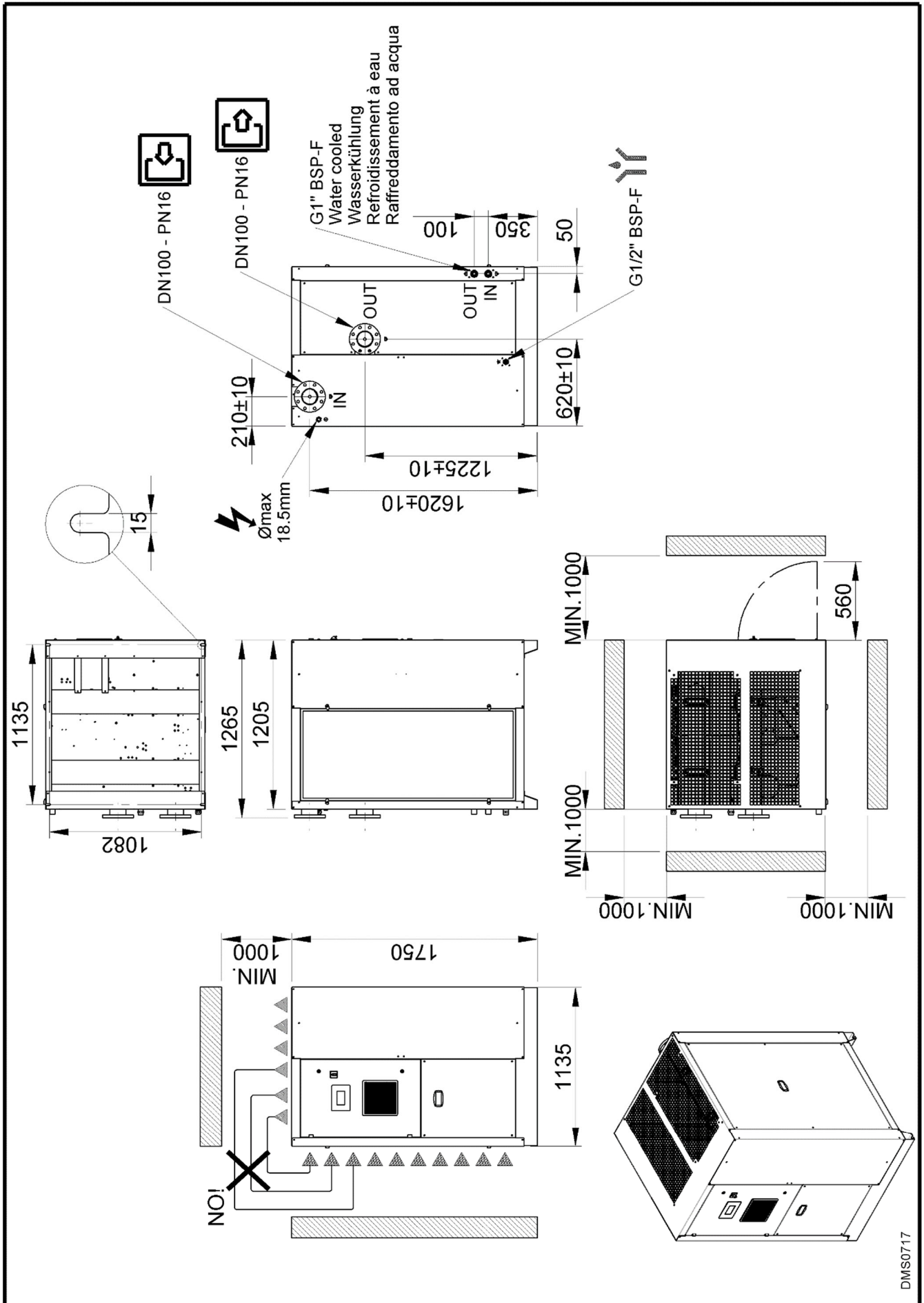

DMS0717

13.2 Exploded views

13.2.1 DRYPOINT RA 1300-2200 eco Air-cooled

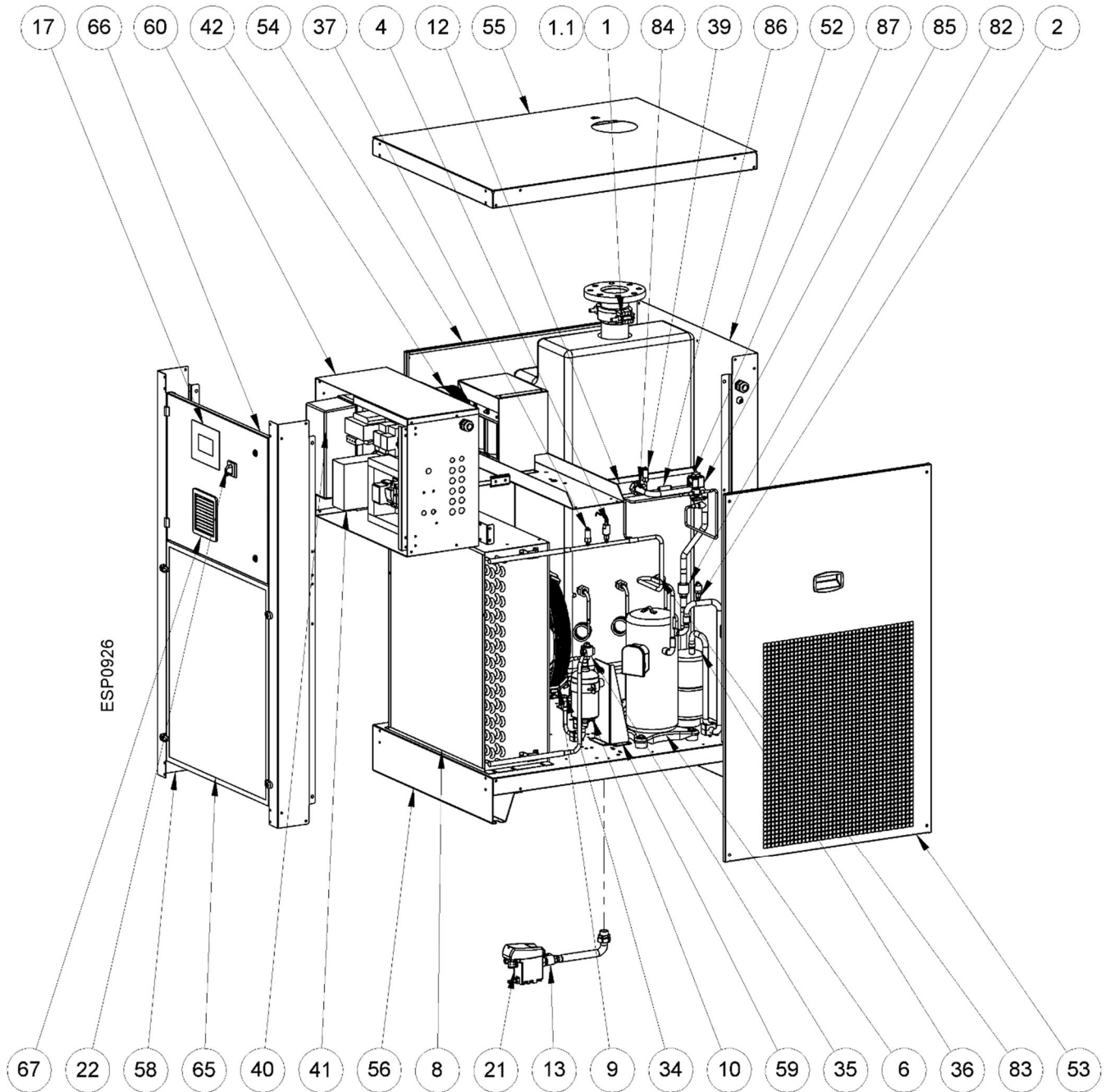

13.2.2 DRYPOINT RA 1300-2200 eco Water-cooled

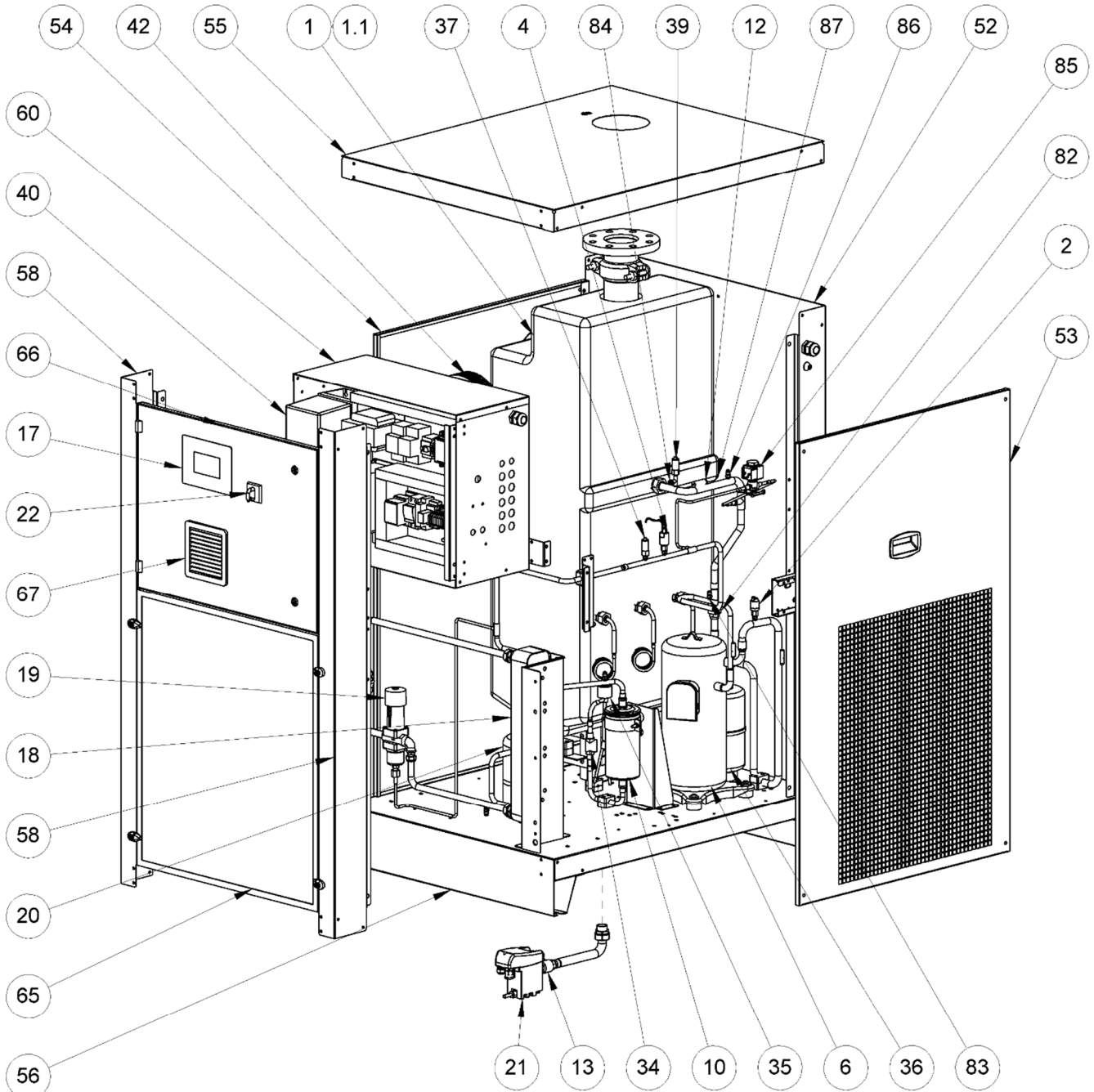

ESP0927

13.2.3 DRYPOINT RA 2400-4400 eco Air-cooled

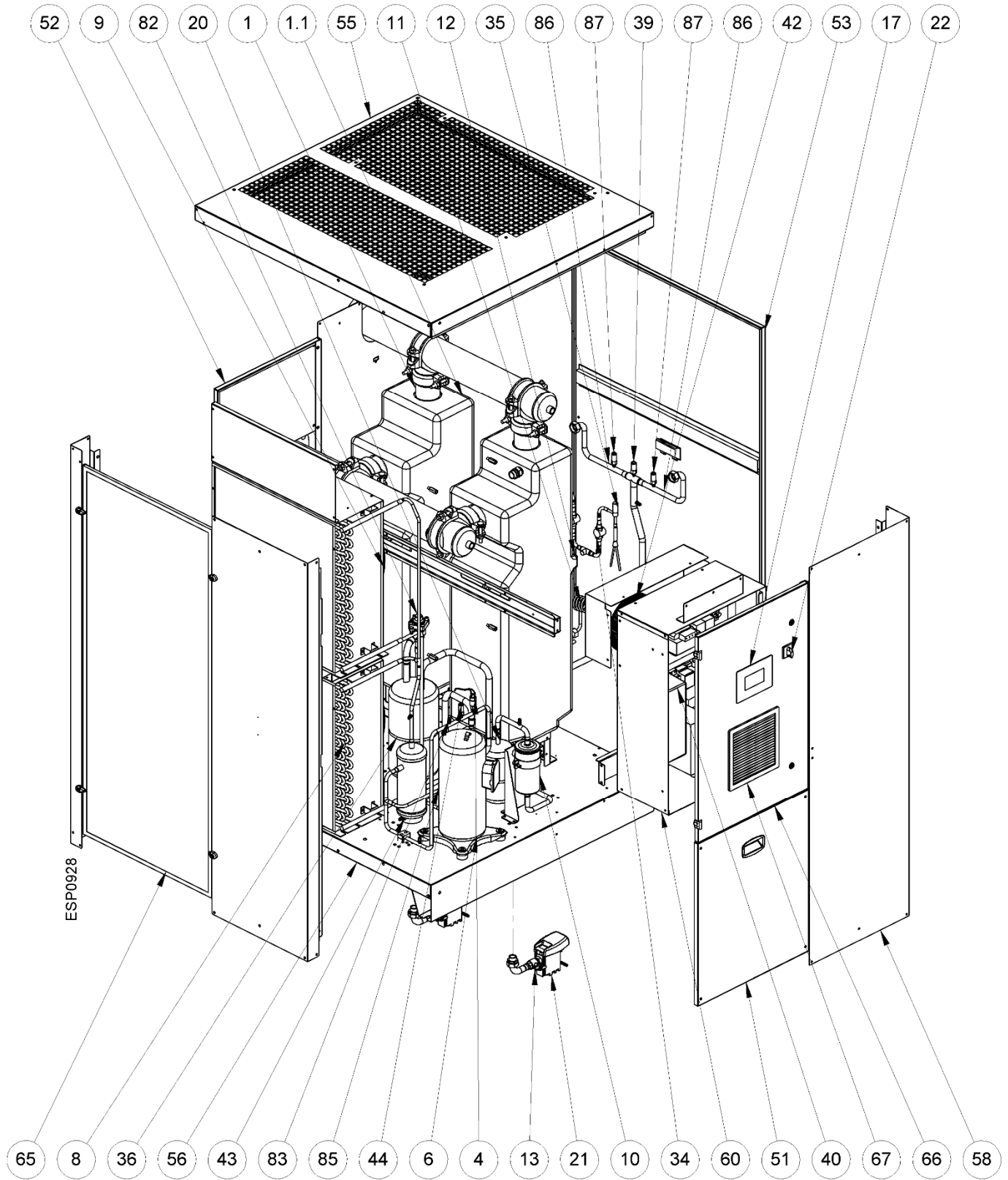

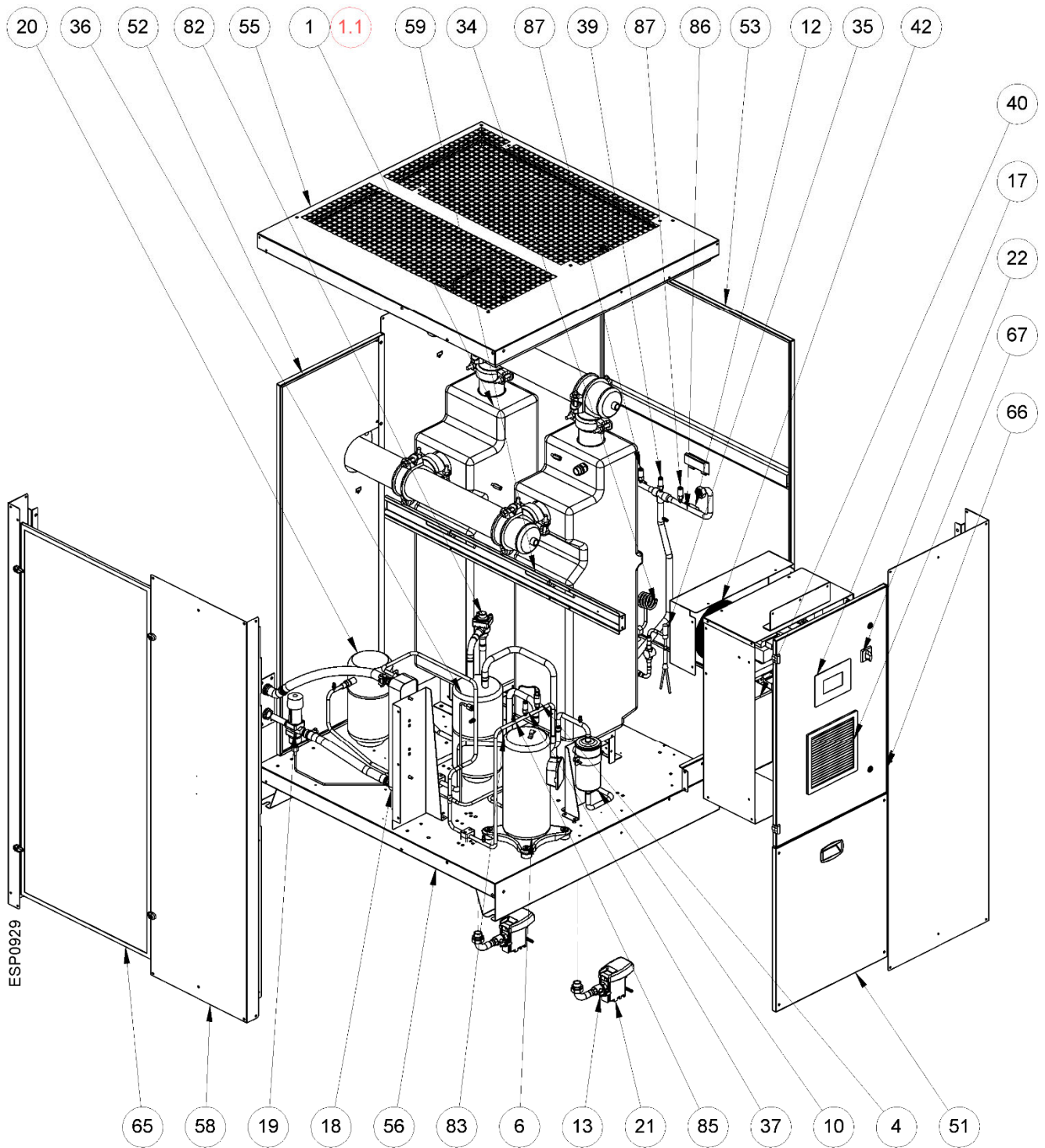

13.3 Electric diagrams

13.3.1 DRYPOINT RA 1300-2200 eco

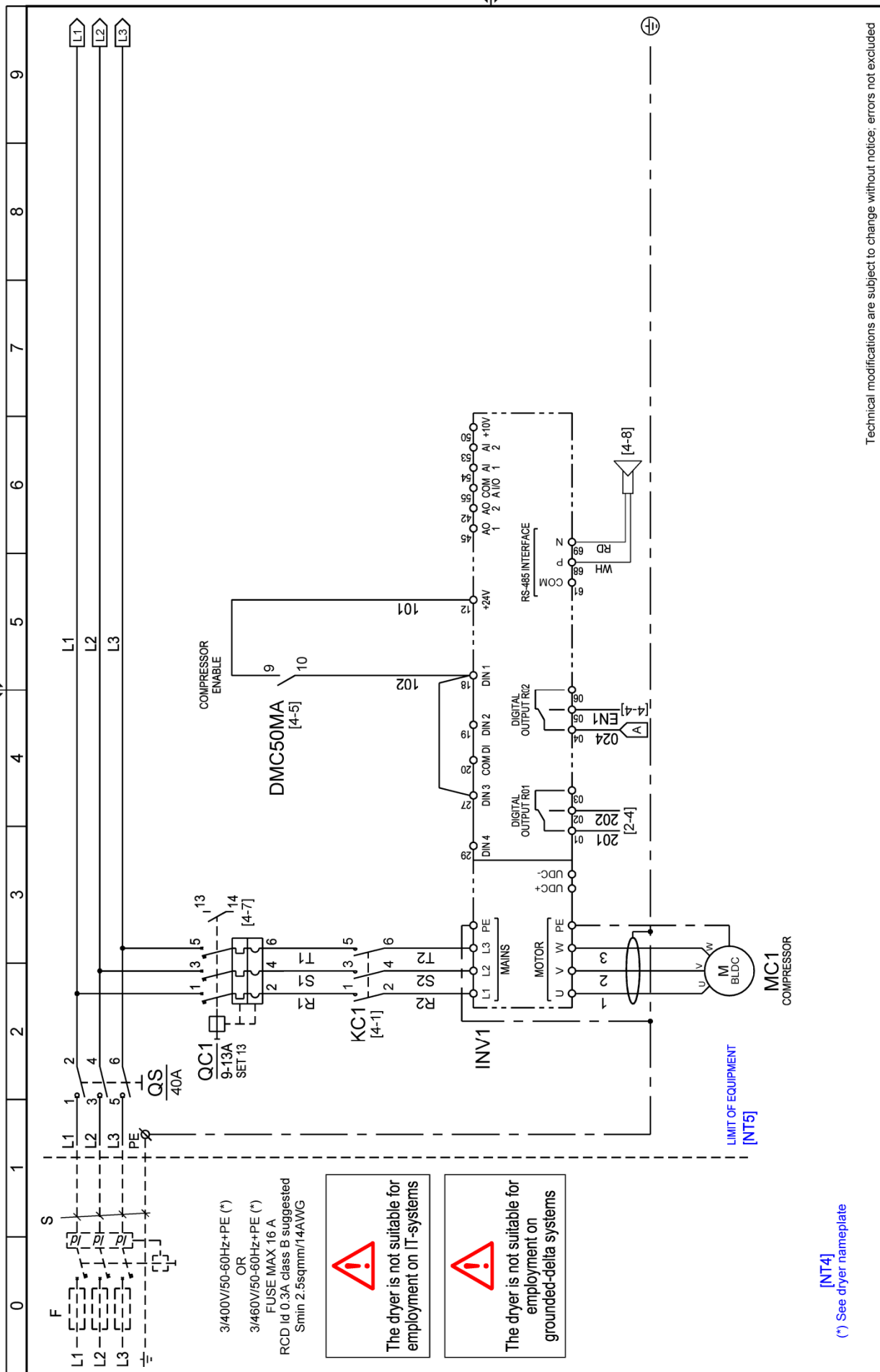

Technical modifications are subject to change without notice; errors not excluded

Drawing no.: **WD5478QCCD050_V00**
 Rev. **02**
 Note: **Sheet 01 of 06**

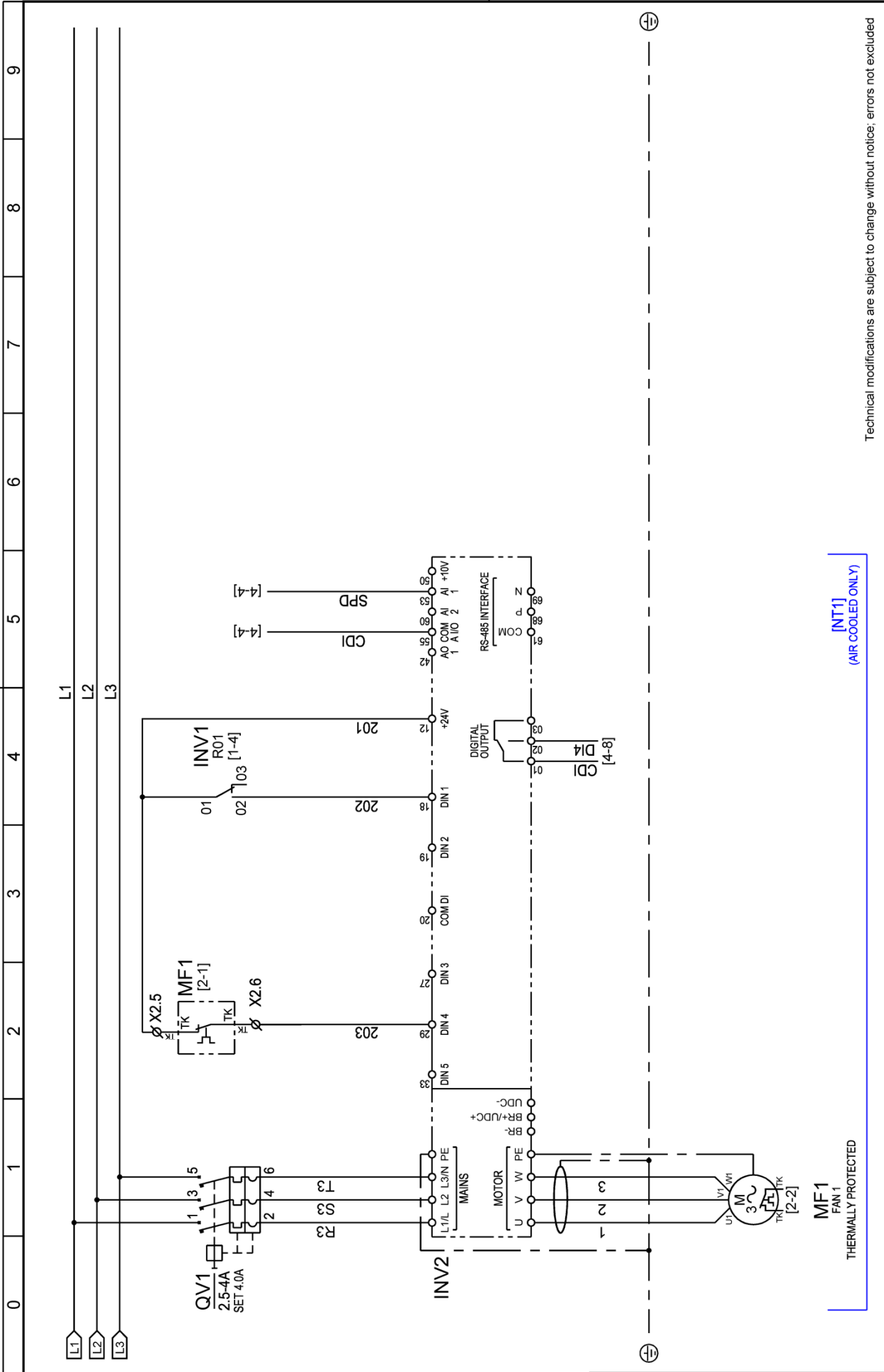

[NT1]
(AIR COOLED ONLY)

MF1
FAN 1
THERMALLY PROTECTED

Technical modifications are subject to change without notice; errors not excluded

Drawing no. : **WD5478QCD050_V00** Rev. **02**
 Note :
 Sheet **02** of **06**

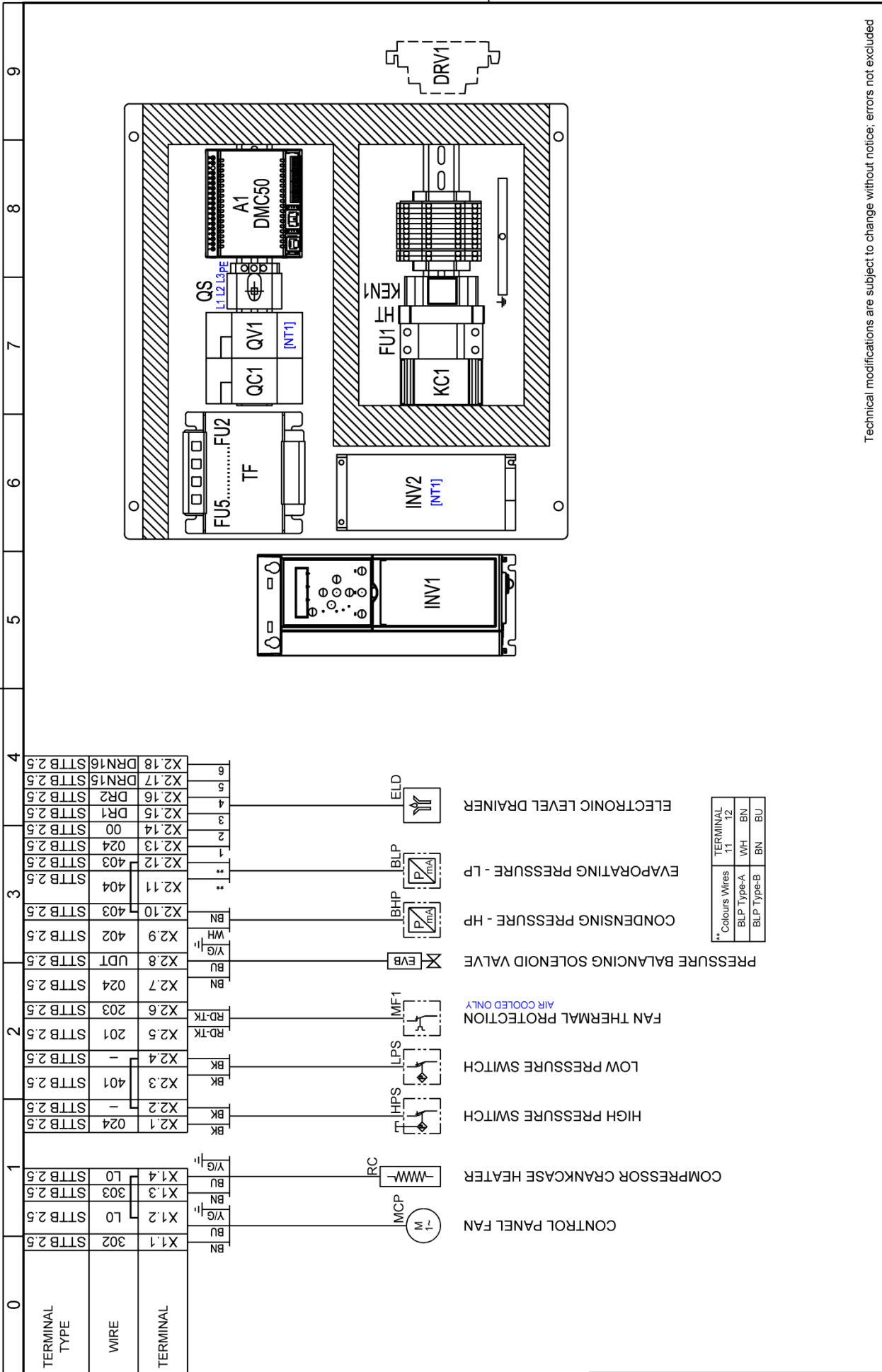

Technical modifications are subject to change without notice; errors not excluded

Drawing no.: **WD5478QCDD050_V00** Rev. **02**

Note: Sheet **06** of **06**

13.3.2 DRYPOINT RA 2400-2900 eco

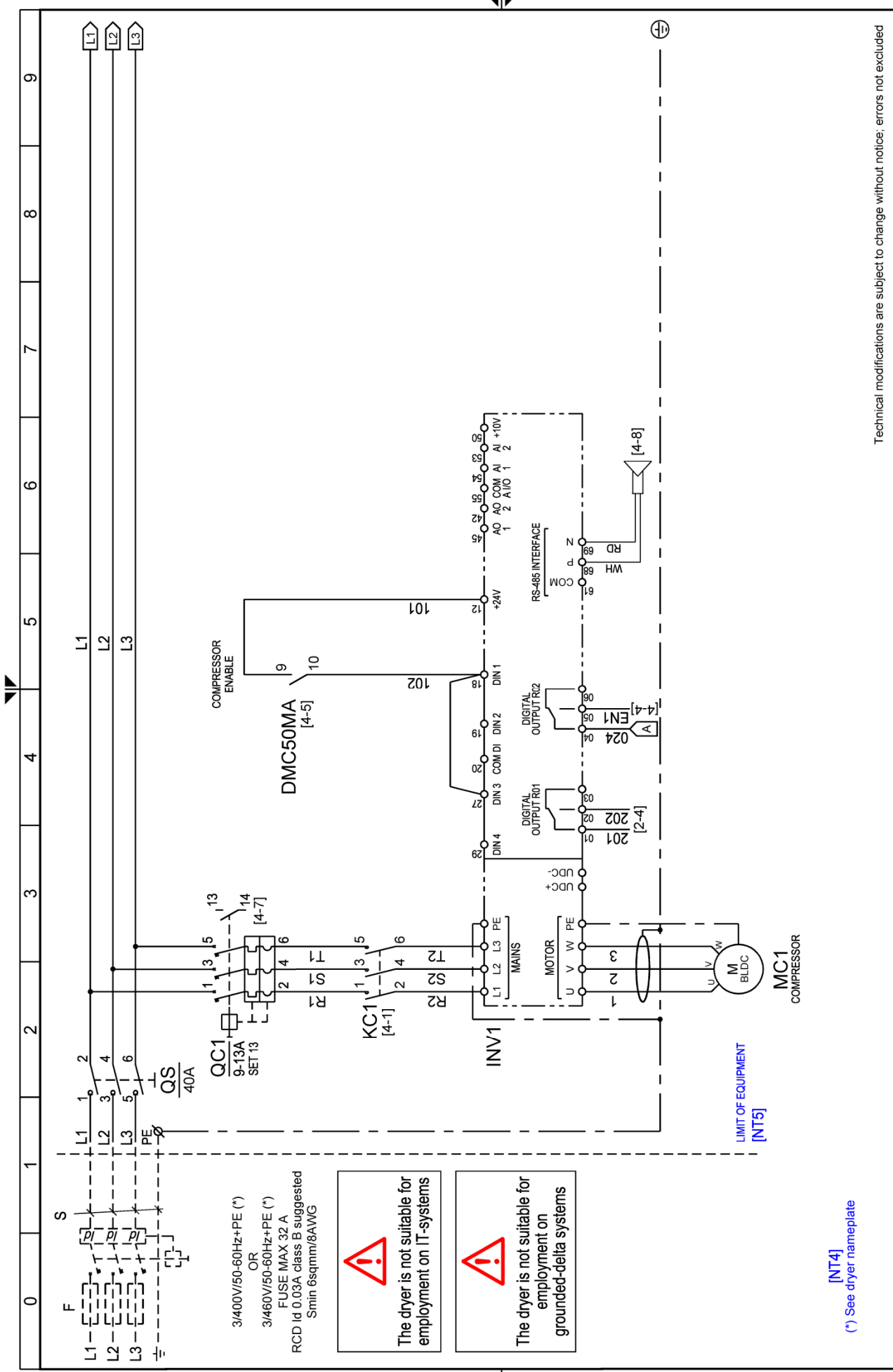

Technical modifications are subject to change without notice, errors not excluded

Rev.

WD5478QCD051_V00 02

Note :

Sheet 01 of 07

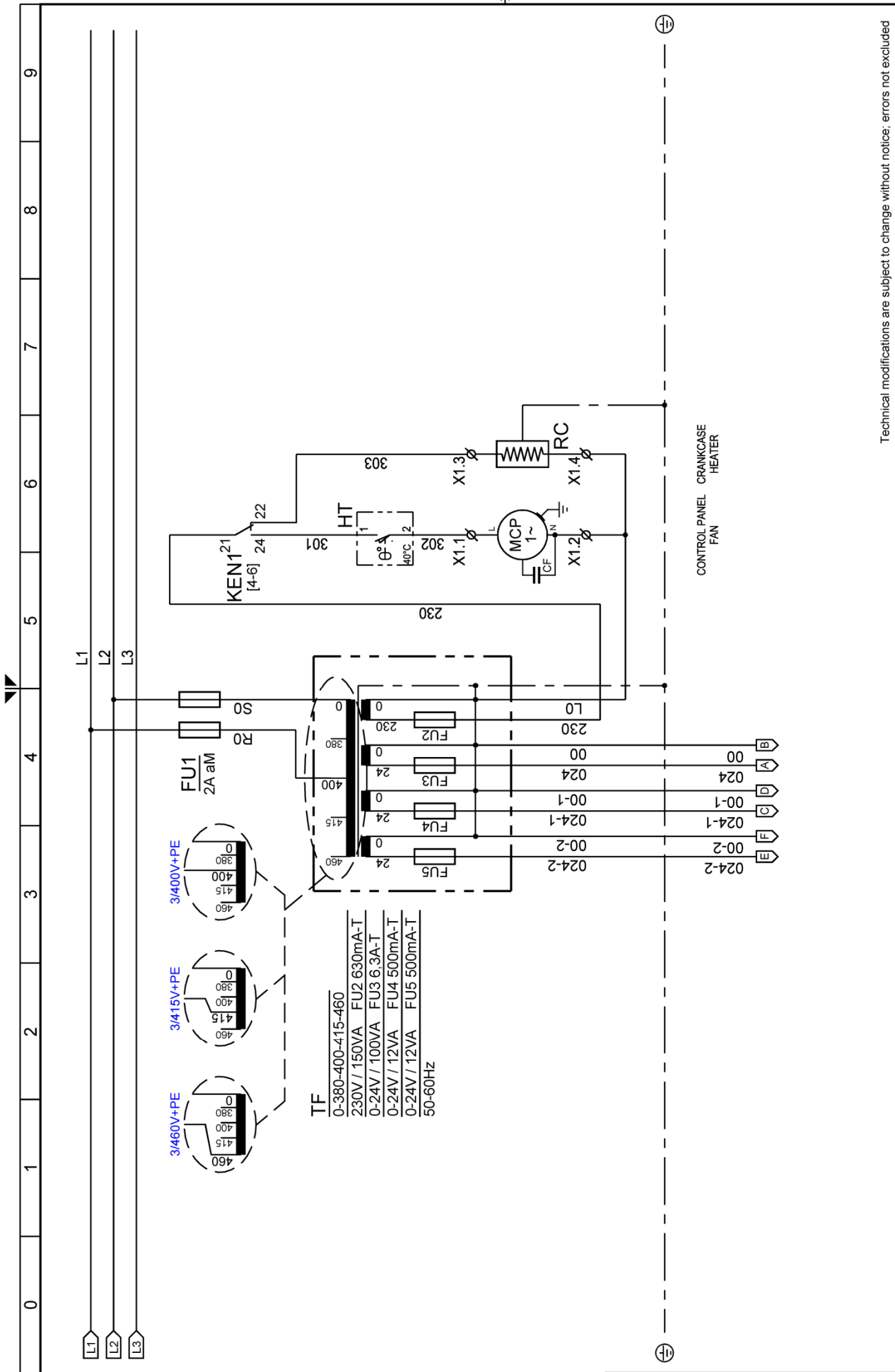

Technical modifications are subject to change without notice; errors not excluded

Drawing no. : WD5478QCD051_V00

Rev. : 02

Note : -

Sheet 03 of 07

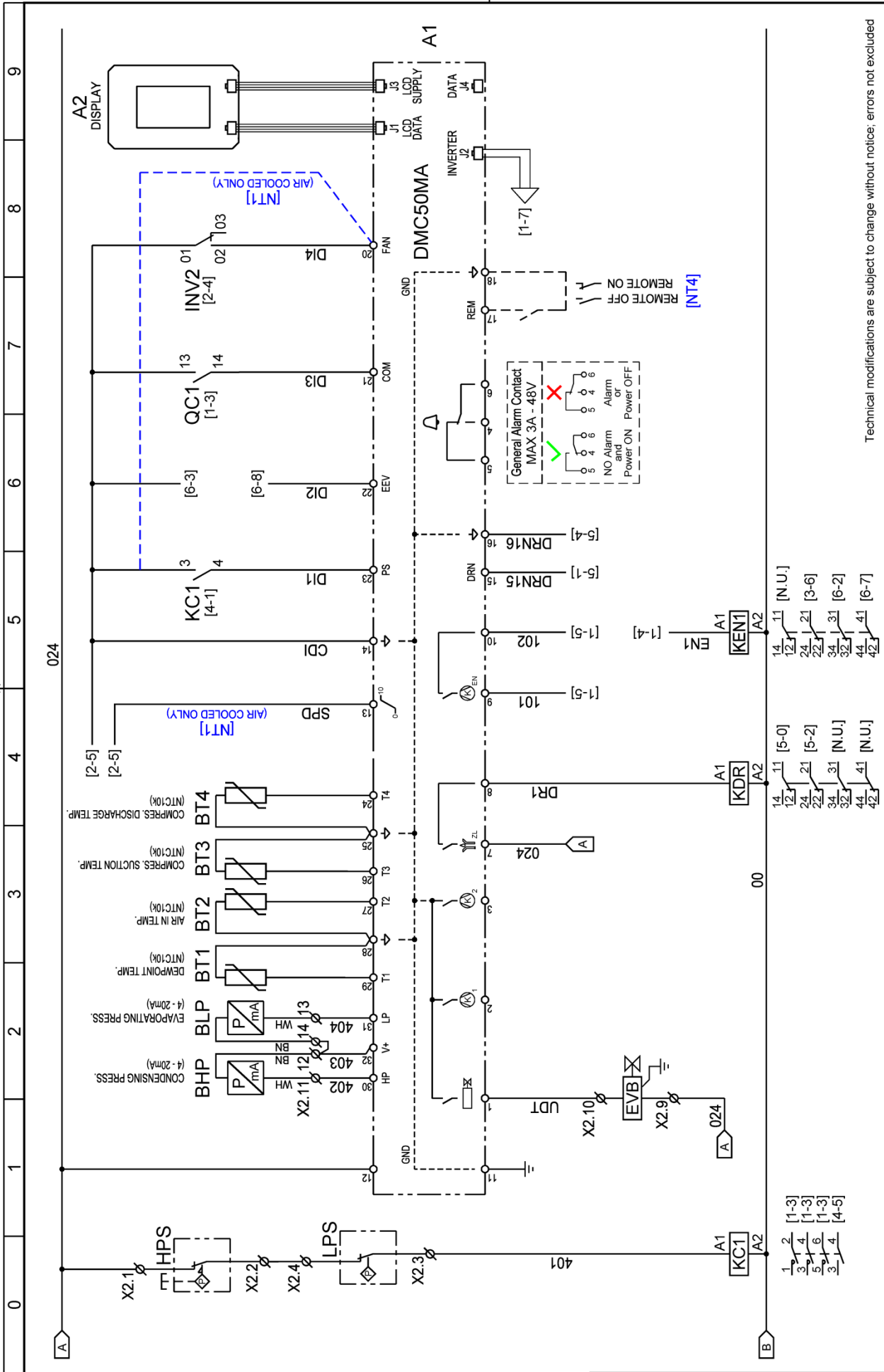

Technical modifications are subject to change without notice; errors not excluded

Drawing no.: **WD5478QCDD051_V00**

Rev.: **02**
 Note:

Sheet **04** of **07**

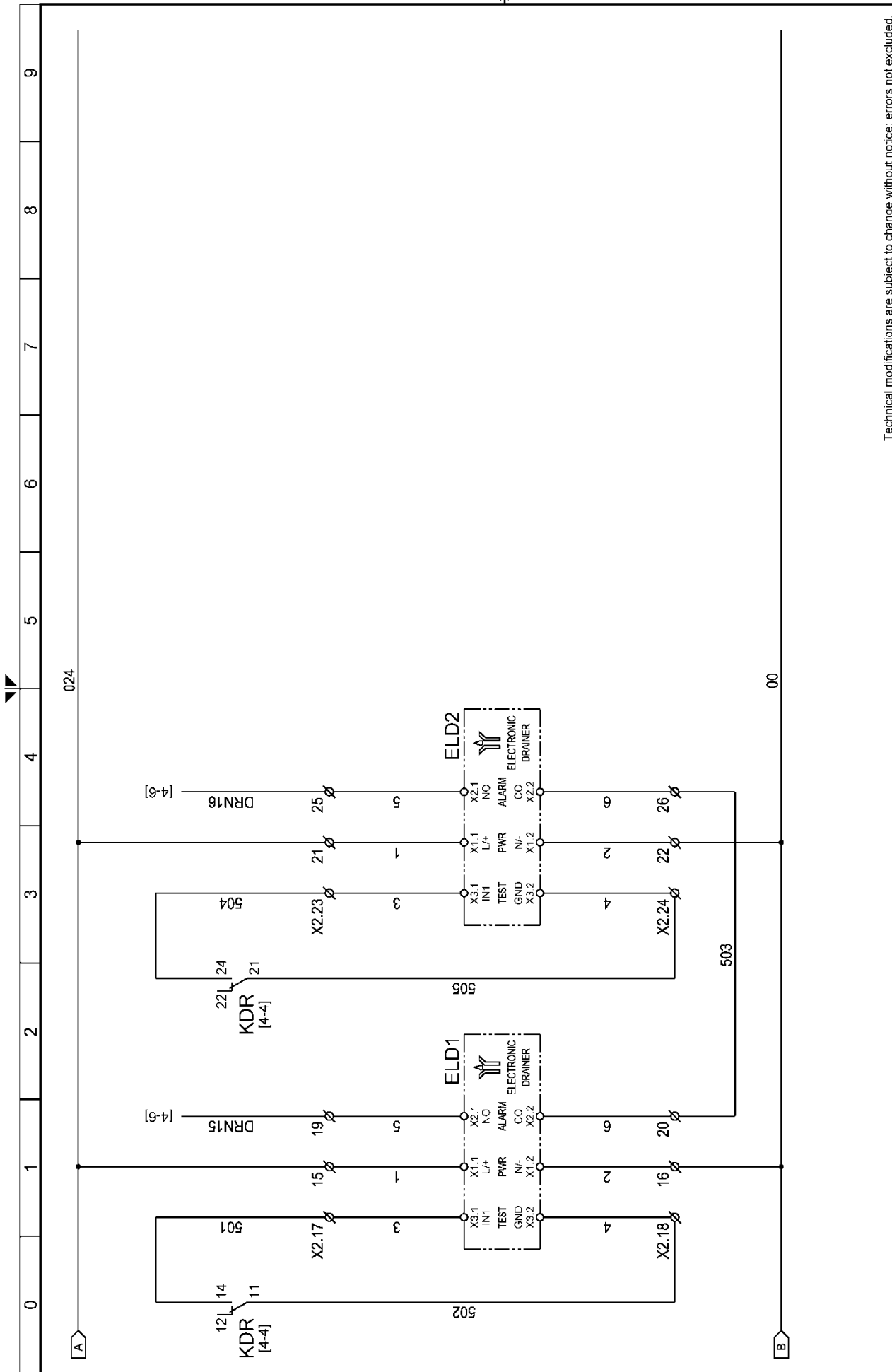

Technical modifications are subject to change without notice; errors not excluded.

Drawing no. : WD5478QCD051_V00

Rev. : 02

Note : -

Sheet 05 of 07

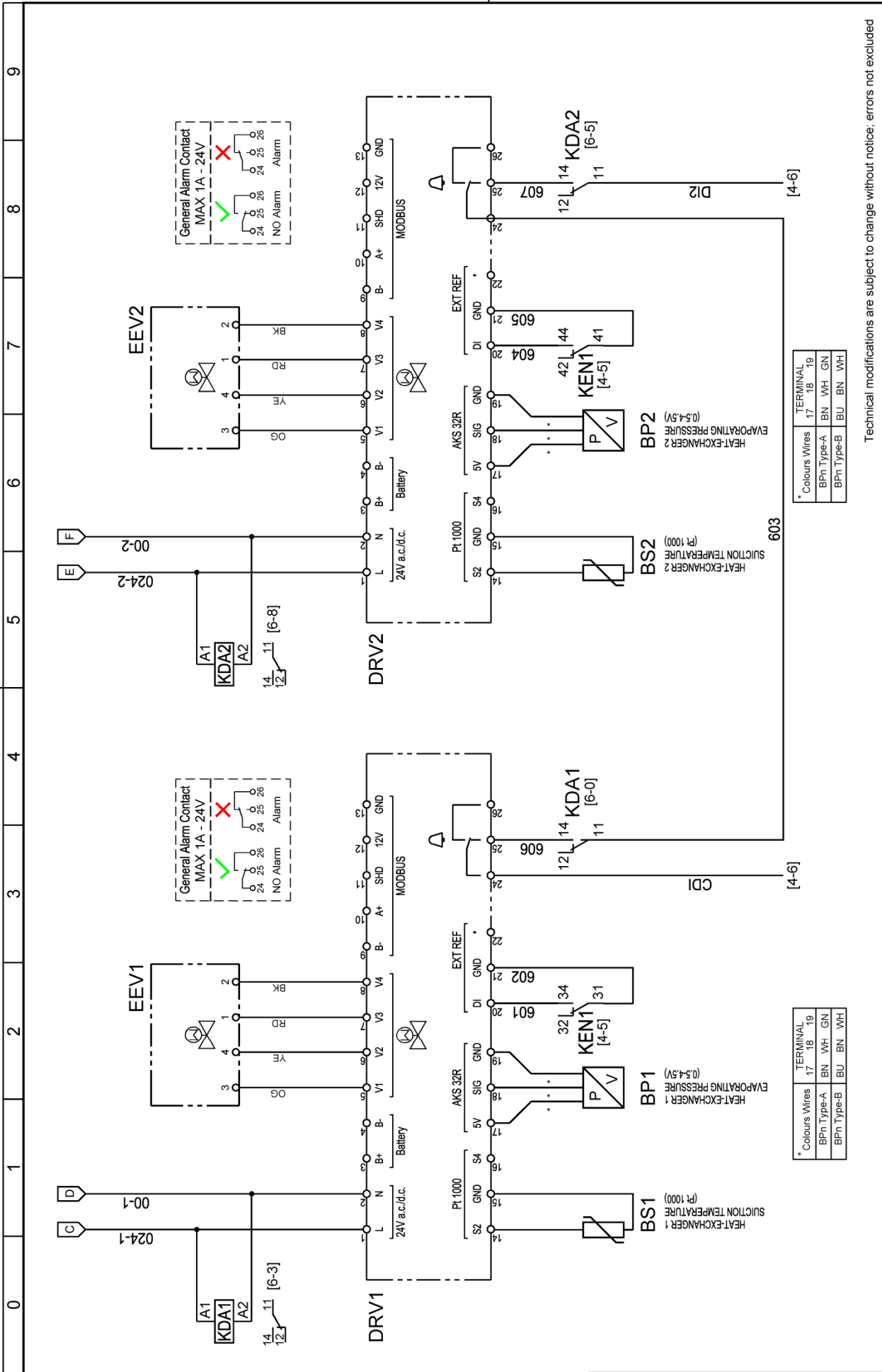

Technical modifications are subject to change without notice; errors not excluded

Drawing no. : WD5478QCD051_V00

Rev. 02

Note :

Sheet 06 of 07

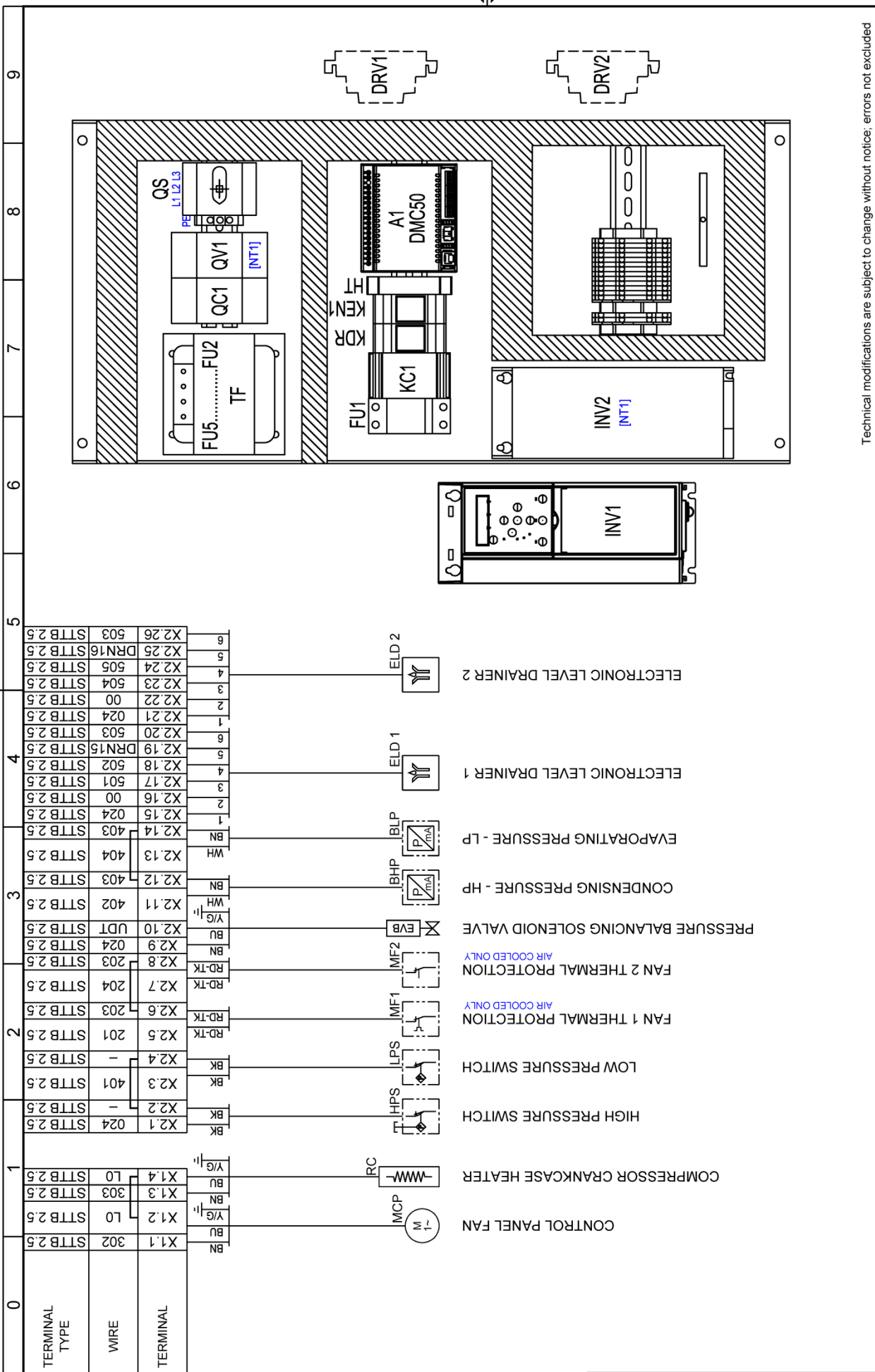

Technical modifications are subject to change without notice; errors not excluded

Drawing no. : **WD5478QCDD051_V00**
 Rev. **02**
 Note :

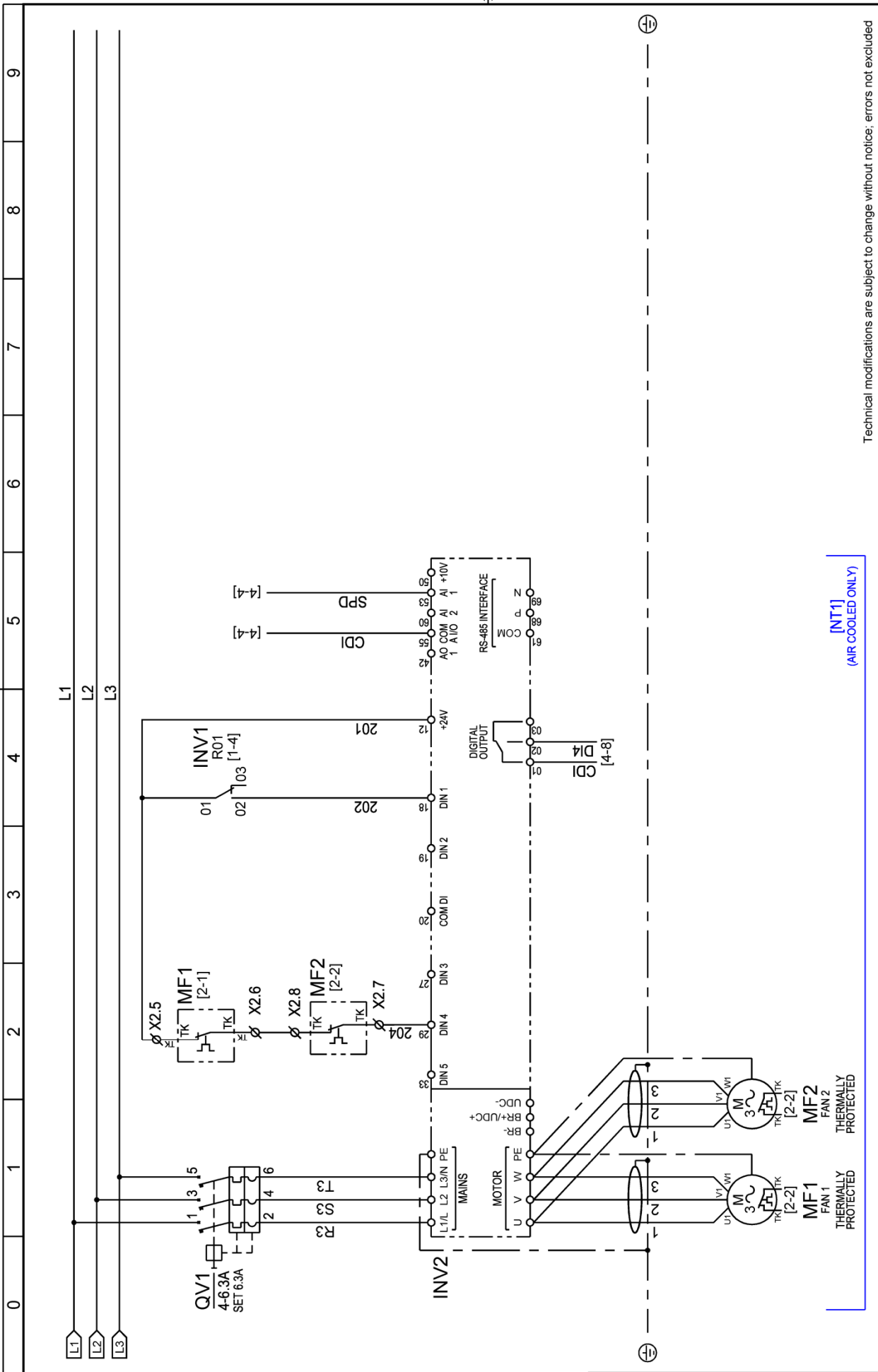

Technical modifications are subject to change without notice; errors not excluded

Drawing no. : WD5478QCD052_V00

Rev. : 01

Note : .

Sheet 02 of 07

[NT1]
(AIR COOLED ONLY)

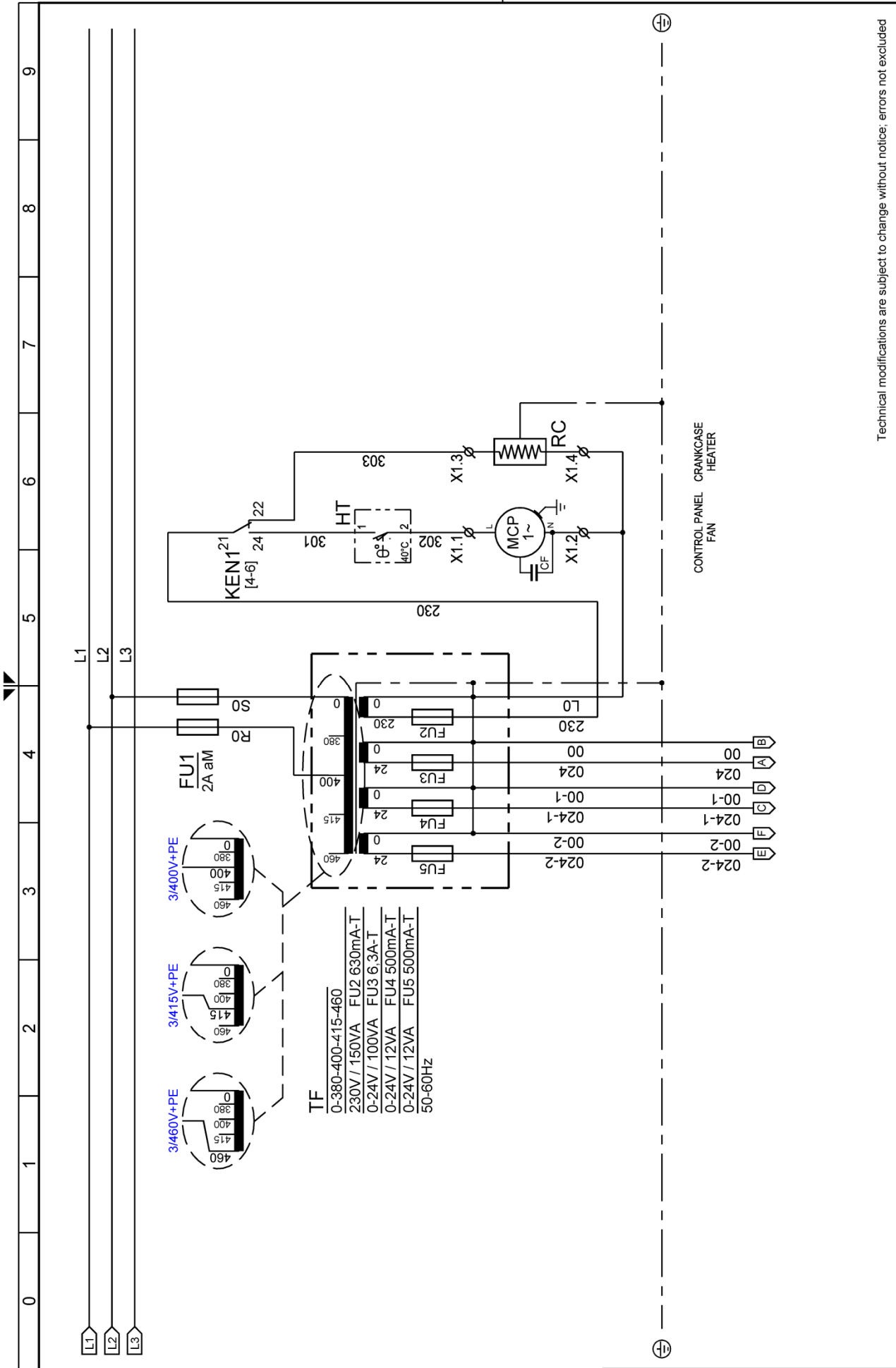

Technical modifications are subject to change without notice; errors not excluded

Drawing no. : WD5478QCCD052_V00

Rev. 01

Note :

Sheet 03 of 07

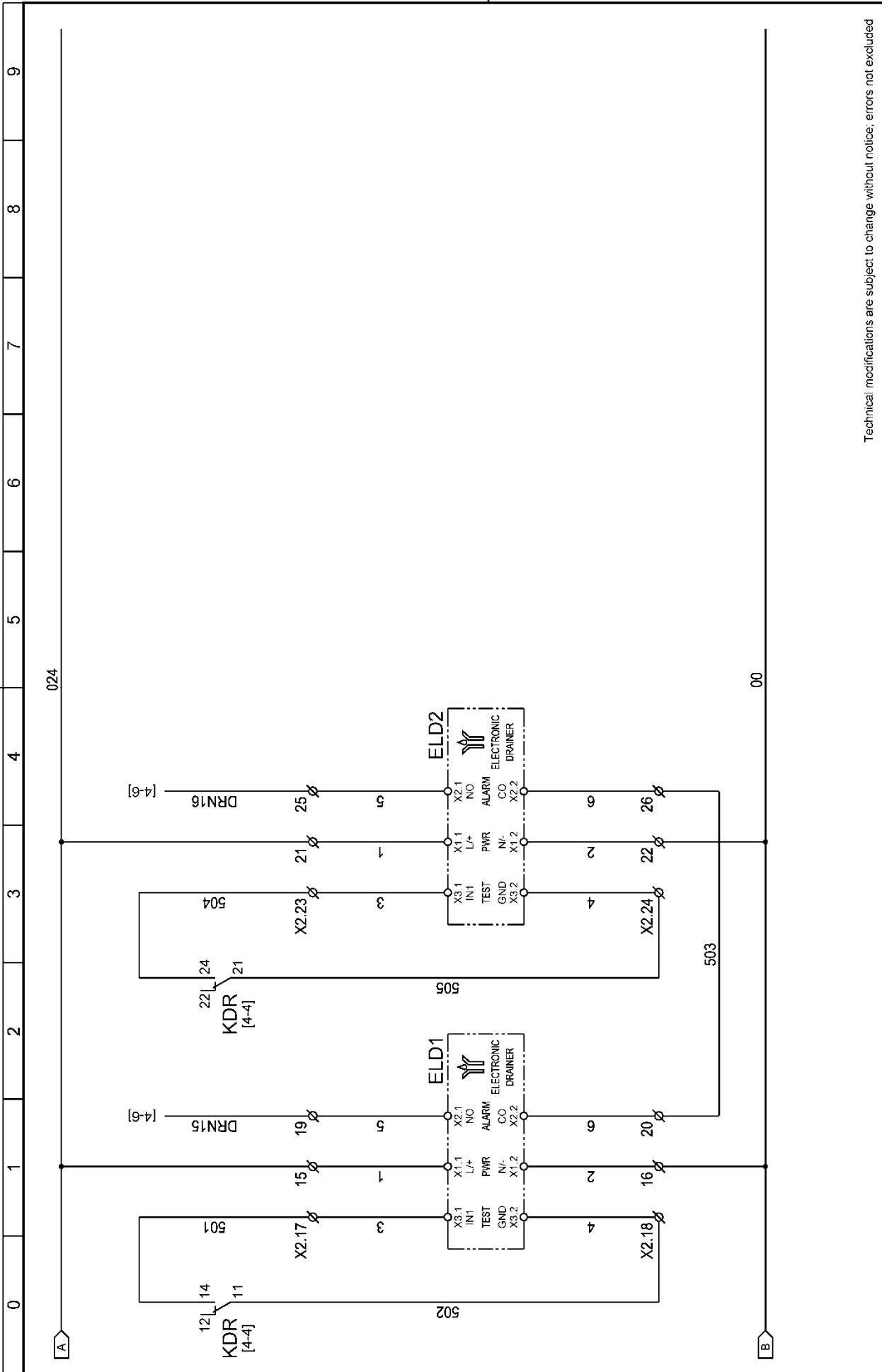

Technical modifications are subject to change without notice; errors not excluded

Drawing no. : WD5478QCD052_V00

Rev. 01

Note : -

Sheet 05 of 07

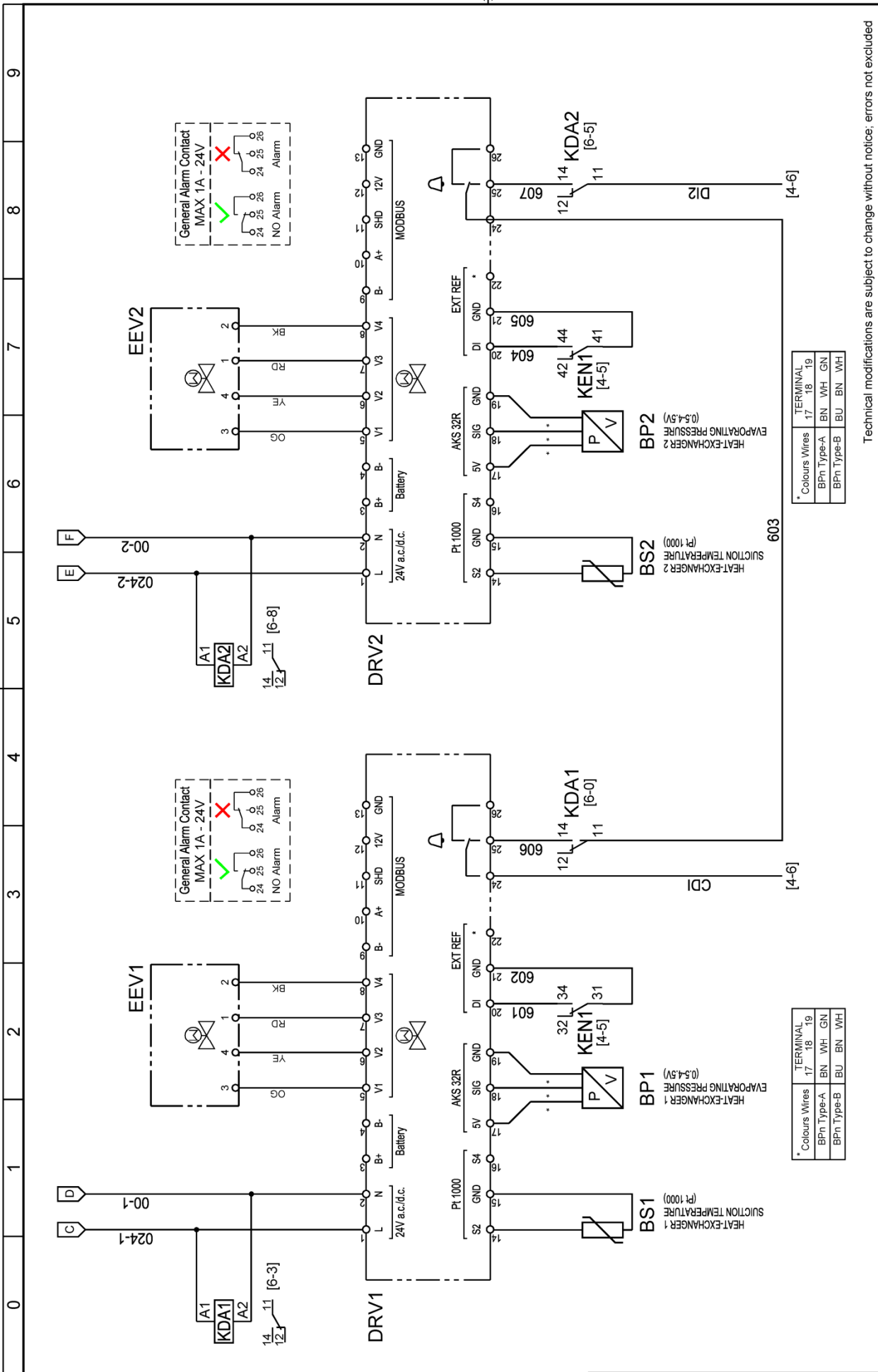

Technical modifications are subject to change without notice; errors not excluded

Drawing no. : WD5478QCD052_V00

Rev. 01

Note :

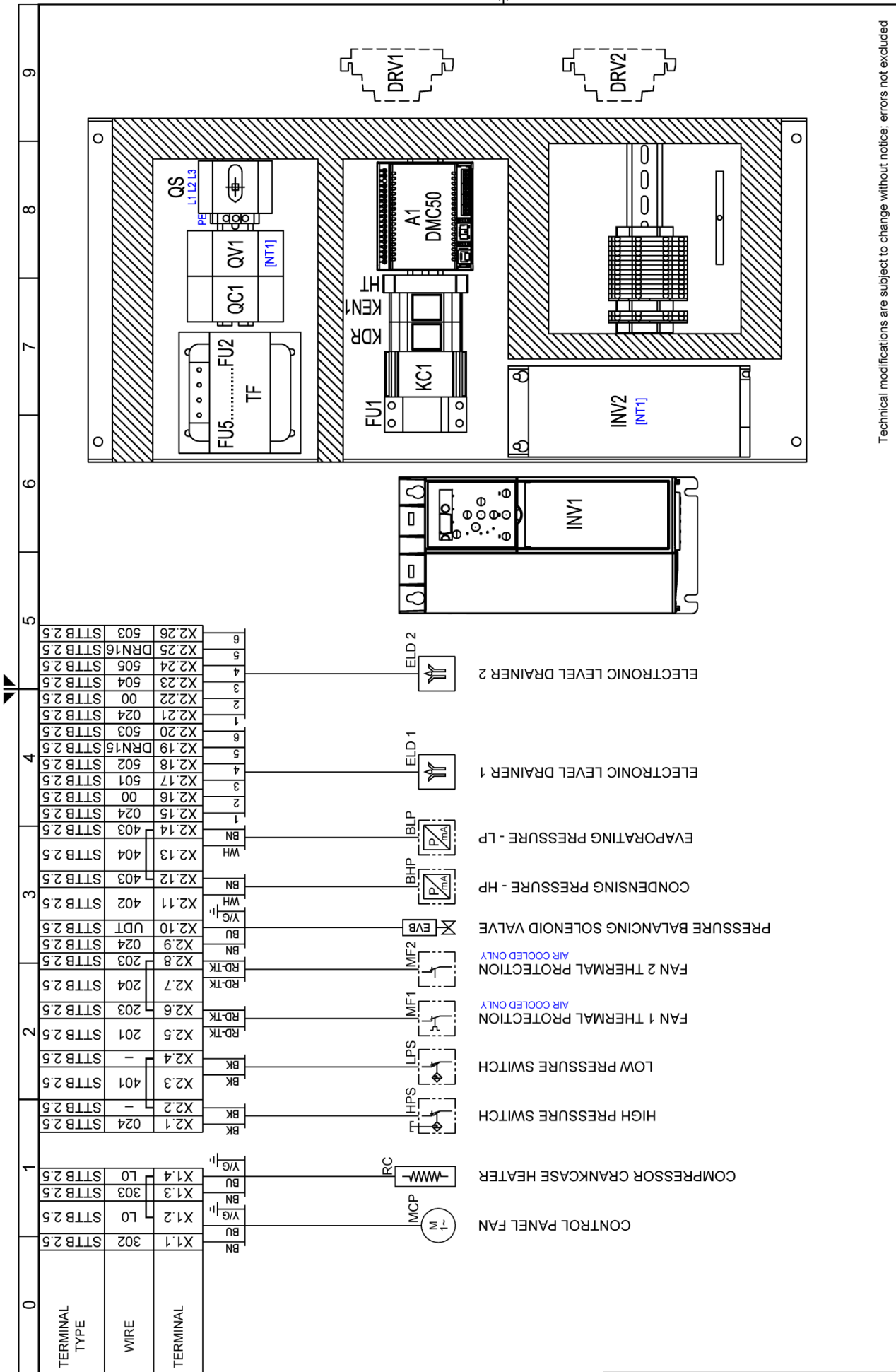

Technical modifications are subject to change without notice; errors not excluded

Drawing no. : WD5478QCDD052_V00

Rev. 01

Note :

Sheet 07 of 07

14 EC declaration of conformity

BEKO TECHNOLOGIES GMBH
Im Taubental 7
41468 Neuss

GERMANY

Phone: +49 2131 988-0
www.beko-technologies.com



EU Declaration of Conformity

We hereby declare that the products named below comply with the stipulations of the relevant directives and technical standards. This declaration only refers to products in the condition in which they have been placed into circulation. Parts which have not been installed by the manufacturer and/or modifications which have been implemented subsequently remain unconsidered.

Product designation:	DRYPOINT® RA ... AC or AC TAC or AC TAC OF and DRYPOINT® RA ... WC or WC TBH or WC TBH OF
Types:	750 eco, 870 eco, 960 eco, 1300 eco, 1800 eco, 2200 eco, 2400 eco, 2900 eco, 3600 eco, 4400 eco, 5400 eco, 6600 eco, 7200 eco, 8800 eco, 10800 eco
Supply voltage versions:	115, 230, 400, 440, 460 VAC (50 ... 60 Hz)
Max. operating pressure:	14 bar(g)
Product description and function:	Refrigeration dryer to reduce the pressure dew point in compressed air

Machinery Directive 2006/42/EC

Applied harmonised standards:	EN 14119, EN 14120, EN 12100, EN 13849-1; EN 60204-1
Name of the authorised Documentation Representative:	Jürgen Hütter, Im Taubental 7, 41468 Neuss, Germany

Pressure Equipment Directive 2014/68/EU

Applied harmonised standards:	ASME VIII Div. 1, EN 378-2, EN 10028-3, EN 12451
Applied conformity assessment procedure:	Module A2
Notified body:	British Engineering Services, Manchester, UK

Low Voltage Directive 2014/35/EU

Applied harmonised standards:	EN 60204-1
-------------------------------	------------

EMC Directive 2014/30/EU

Applied harmonised standards:	EN 61000-6-2:2016, EN 61000-6-4:2018
-------------------------------	--------------------------------------

RoHS II Directive 2011/65/EU

The products meet the requirements laid down in European Directive 2011/65/EU concerning the restriction of the use of certain hazardous substances in electrical and electronic devices.

The products bear the CE Mark:

CE 0040

The manufacturer shall have sole responsibility for issuing this declaration of conformity.

Neuss, 11.05.2020

Signed for and on behalf of:

BEKO TECHNOLOGIES GMBH

i.V. Christian Riedel

EU-decl_DP_RA_750_eco-RA_10800_eco_en_05_2020

BEKO TECHNOLOGIES GmbH

Im Taubental 7
 D - 41468 Neuss
 Tel. +49 2131 988 0
 Fax +49 2131 988 900
 info@beko-technologies.com
 service-eu@beko-technologies.com

DE

BEKO TECHNOLOGIES LTD.

Unit 11-12 Moons Park
 Burnt Meadow Road
 North Moons Moat
 Redditch, Worcs, B98 9PA
 Tel. +44 1527 575 778
 info@beko-technologies.co.uk

GB

BEKO TECHNOLOGIES S.à.r.l.

Zone Industrielle
 1 Rue des Frères Rémy
 F - 57200 Sarreguemines
 Tél. +33 387 283 800
 info@beko-technologies.fr
 service@beko-technologies.fr

FR

BEKO TECHNOLOGIES B.V.

Veenen 12
 NL - 4703 RB Roosendaal
 Tel. +31 165 320 300
 benelux@beko-technologies.com
 service-bnl@beko-technologies.com

NL

BEKO TECHNOLOGIES (Shanghai) Co. Ltd.

Rm.715 Building C, VANTONE Center
 No.333 Suhong Rd.Minhang District
 201106 Shanghai
 Tel. +86 (21) 50815885
 info.cn@beko-technologies.cn
 service1@beko.cn

CN

BEKO TECHNOLOGIES s.r.o.

Na Pankraci 58
 CZ - 140 00 Praha 4
 Tel. +420 24 14 14 717 /
 +420 24 14 09 333
 info@beko-technologies.cz

CZ

BEKO Tecnológica España S.L.

Torruella i Urpina 37-42, nave 6
 E - 08758 Cervelló
 Tel. +34 93 632 76 68
 Mobil +34 610 780 639
 info.es@beko-technologies.es

ES

BEKO TECHNOLOGIES LIMITED

Room 2608B, Skyline Tower,
 No. 39 Wang Kwong Road
 Kwoloon Bay Kwoloon, Hong Kong
 Tel. +852 2321 0192
 Raymond.Low@beko-technologies.com

HK

BEKO TECHNOLOGIES INDIA Pvt. Ltd.

Plot No.43/1 CIEEP Gandhi Nagar
 Balanagar Hyderabad
 IN - 500 037
 Tel. +91 40 23080275 /
 +91 40 23081107
 Madhusudan.Masur@bekoindia.com
 service@bekoindia.com

IN

BEKO TECHNOLOGIES S.r.l

Via Peano 86/88
 I - 10040 Leini (TO)
 Tel. +39 011 4500 576
 Fax +39 0114 500 578
 info.it@beko-technologies.com
 service.it@beko-technologies.com

IT

BEKO TECHNOLOGIES K.K

KEIHIN THINK Building 8 Floor
 1-1 Minamiwatarida-machi
 Kawasaki-ku, Kawasaki-shi
 JP - 210-0855
 Tel. +81 44 328 76 01
 info@beko-technologies.jp

JP

BEKO TECHNOLOGIES Sp. z o.o.

ul. Pańska 73
 PL - 00-834 Warszawa
 Tel. +48 22 314 75 40
 info.pl@beko-technologies.pl

PL

BEKO TECHNOLOGIES S. de R.L. de C.

BEKO Technologies, S de R.L. de C.V.
 Blvd. Vito Alessio Robles 4602 Bodega 10
 Zona Industrial
 Saltillo, Coahuila, 25107
 Mexico
 Tel. +52(844) 218-1979
 informacion@beko-technologies.com

MX

BEKO TECHNOLOGIES CORP.

900 Great Southwest Pkwy SW
 US - Atlanta, GA 30336
 Tel. +1 404 924-6900
 Fax +1 (404) 629-6666
 beko@bekousa.com

US

