

Original installation and operation manual

BEKOMAT® 13 Vario **BEKOMAT® 13 Vario CO**

- > BM13V
- > BM13VCO

■ Table of contents

1. Notes about the documentation	4
1.1 Contact	4
1.2 Information regarding installation and operation manual	4
1.3 Other applicable documents	4
2. Safety	5
2.1 Use	5
2.1.1 Intended use	5
2.1.2 Reasonably foreseeable inappropriate use	5
2.2 Responsibility of the operating company	6
2.3 Target group and personnel.....	7
2.4 Explanation of the symbols used	8
2.5 Safety instructions	9
3. Product information	11
3.1 Product description.....	11
3.2 Product overview	11
3.3 Function description	12
3.4 Type plate	13
3.5 Scope of delivery	13
4. Technical data	14
4.1 Operating parameters	14
4.2 Storage and transport parameters	15
4.3 Materials.....	15
4.4 Dimensions.....	15
4.5 Installation dimensions.....	16
4.6 Terminal diagrams.....	16
4.6.1 Power control board	16
4.6.2 Control PCB.....	16
5. Transport and storage	17
5.1 Transport	17
5.2 Storage.....	17
6. Assembly	18
6.1 Warning notices	18
6.1.1 General assembly instructions.....	19
6.2 Installation	21

7. Electrical installation	22
7.1 Warning notices	22
7.2 Connection work	23
7.2.1 Voltage supply connection.....	23
7.2.1.1 Power control board AC	23
7.2.1.2 Power control board DC	26
7.2.2 Connection of potential free contact	28
7.2.3 Connection of external TEST	29
8. Commissioning	30
8.1 Warning notices	30
8.2 Commissioning work.....	30
9. Operation	31
9.1 Operating states	31
10. Maintenance	33
10.1 Warning notices	33
10.2 Maintenance schedule	33
10.3 Maintenance work	34
10.3.1 Wear parts exchange	34
10.3.2 Cleaning work	42
10.3.3 Visual inspection	43
10.3.4 Leakage test.....	43
11. Consumables, accessories and spare parts	44
11.1 Order information.....	44
11.2 Accessories.....	44
11.3 Spare parts.....	45
12. Decommissioning	49
12.1 Warning notices	49
12.2 Decommissioning work	49
13. Disassembly	50
14. Disposal	51
14.1 Warning notices	51
14.2 Disposal work	52
15. Troubleshooting / FAQ	53
16. Appendices	54
16.1 Approval certificates and declarations of conformity.....	54
16.2 Exploded drawing	58


1. Notes about the documentation

This documentation contains all the necessary steps for installation and operation of the product and the accessories.

1.1 Contact

Manufacturer	Customer service and tools
BEKO TECHNOLOGIES GmbH Im Taubental 7 D-41468 Neuss Tel. + 49 2131 988 - 1000 info@beko-technologies.com www.beko-technologies.com	BEKO TECHNOLOGIES GmbH Im Taubental 7 D-41468 Neuss Tel. + 49 2131 988 - 1000 service-eu@beko-technologies.com www.beko-technologies.com


1.2 Information regarding installation and operation manual

INFORMATION	Copyright protection!
	The contents of the installation and operation manual in the form of text, figures, illustrations, photographs, technical drawings, diagrams and other representations are protected by the copyright of the manufacturer. This applies especially to duplication, reproduction, microfilming and storage as well as processing in electronic systems.

Publication date	Revision	Version	Reason for amendment	Scope of amendment
01/01/2020	00	00	Changes to standards and regulations	Completely new version
01/11/2025	01	00	Added tool	Section 10.3

The installation and operation manual, hereinafter referred to as the manual, must always be kept close to the product and be in a permanently legible condition.

The manual must be handed over along with the product if it is sold or passed on.

NOTE	Follow the instructions given in the manual!
	This manual contains all the basic information required for safe operation of the product and must therefore be read before any actions are performed. Otherwise personal and material hazards as well as malfunction and device failure are possible.

1.3 Other applicable documents

More detailed information can be obtained from the following documents:

- Installation and operation manual: Thermostatically controlled heating system and insulation shell
- Installation and operation manual: Trace heater

2. Safety

2.1 Use

2.1.1 Intended use

The **BEKOMAT**®, also termed product below, is an electronically level-controlled condensate drain used for draining off condensate in compressed gas systems.

Any use of this system other than the use described in this manual is hereby deemed to be non-intended and can cause a hazard for the safety of people and the environment.

The following must be noted for intended use:

- Read and follow the manual.
- Only operate the product and accessories with media which are free of caustic, aggressive, corrosive, toxic, flammable, oxidising or inorganic components.
In cases of doubt an analysis must be carried out.
- Only use the product and the accessories in wet surroundings where only splashwater, free of corroding components, can occur.
- Only use the product and accessories within the operating parameters given in the technical data and the agreed delivery conditions.
- Only use the product and accessories within the piping system designed for the technical data with appropriate connections, pipe diameters and assembly clearance.
- Only use the product and accessories in areas which are free of toxic and corrosive chemicals and gases.
- Only use the product and accessories outside potentially explosive atmospheres.
- Only use the product and accessories indoors and away from direct solar radiation and heat sources as well as areas subject to frost.
- Only combine the product and accessories with the products named and recommended by **BEKO TECHNOLOGIES GmbH** in the manual.
- Adhere to the prescribed maintenance schedule.

Before using the product and the accessories, the operating company must make sure that all conditions and prerequisites for intended use are given.

The product and the accessories have been exclusively designed for use in a commercial or industrial area. All the assembly, installation, operation, disassembly and disposal work described may only be performed by qualified skilled technical personnel.

2.1.2 Reasonably foreseeable inappropriate use

Reasonably foreseeable inappropriate use is deemed to have occurred if the product or the accessories are used in any other way than that described in the chapter "Intended use". Reasonably foreseeable inappropriate use includes the use of the product or the accessories in a manner not intended by the manufacturer or supplier but which may result from foreseeable human behaviour.

Reasonably foreseeable inappropriate use includes:

- The execution of any kind of modification, in particular constructive and process-technology related interventions.
- The suspension, bridging or non-application of existing or recommended safety equipment.

This list is not exhaustive as not all possible inappropriate use can be foreseen in advance. If the operating company is aware of any inappropriate use of the product or accessories which are not listed here, the manufacturer must be informed immediately.


2.2 Responsibility of the operating company

The responsible operating company must ensure the following to prevent accidents, incidents and adverse effects on the environment:

- Before all actions, check to ensure that the manual available does in fact belong to the product.
- The product and the accessories are used, serviced and repaired in accordance with the intended use.
- All applicable statutory requirements, safety regulations and accident prevention regulations are being adhered to.
- All regulations and operating guidelines for safe working and information regarding behaviour in the event of accidents and fires are accessible at the operating location at all are times.
- The product and accessories are only used with the recommended and fully operable safety equipment.
- All assembly, installation and maintenance work is carried out by qualified skilled technical personnel only.
- Personnel have the necessary personal protective equipment available and also use this equipment.
- Suitable technical safety measures are taken so that the permissible operating parameters are not exceeded or undershot.

2.3 Target group and personnel

This manual addresses the personnel listed below who are involved with work on the product or the accessories.

INFORMATION	Personnel requirements!
	<p>The personnel may not execute any actions on the product or the accessories when they are under the influence of drugs, medications, alcohol or other substances that may impair their consciousness.</p>

Skilled technical personnel - transport and storage

Skilled technical personnel - transport and storage are people who, due to their training, professional experience and qualifications, have all the necessary skills to safely execute all actions in connection with the transport and storage of the product, to instruct, to recognise possible dangerous situations independently and to execute measures to avoid danger.

The capabilities include, in particular, experience with hoists, forklifts and lifting equipment and knowledge of local laws, standards and guidelines relating to transport and storage.

Skilled technical personnel - compressed gas technology

Skilled technical personnel - compressed gas technology are people who, due to their training, professional experience and qualification, possess all the necessary capabilities to safely execute actions, and instruct all actions related to compressed gases and pressurised systems, to independently foresee potential hazardous situations and implement appropriate measures to avert any danger.

The capabilities include, in particular, experience in handling measurement and control technology as well as knowledge of the regionally applicable laws, standards and regulations for compressed gas technology.

Skilled technical personnel - electrical engineering

Skilled technical personnel - electrical engineering are people who, due to their training, professional experience and qualification, have all the necessary capabilities to safely execute all actions related to electricity, to instruct and to independently foresee potential hazardous situations and take appropriate measures to avoid any danger.











The capabilities include, in particular, experience in handling electric voltage plants, measurement and control technology as well as knowledge of the regionally applicable laws, standards and regulations (e.g. VDE 0100 / IEC 60364/ ATEX) applicable for handling electrical technology.

Skilled technical personnel - customer service

Skilled technical personnel - customer service are people who have the skills and qualifications of the skilled personnel named above. Skilled technical personnel - customer service must have documented proof of training for all work on the product and be authorised.

2.4 Explanation of the symbols used

The symbols used below indicate safety-relevant and important information which must be adhered to when handling the product and to ensure safe and optimum operation.


Symbol	Description/Explanation
	General warning symbol (danger, warning, caution)
	Warning: pressurised system
	Warning: electric voltage
	Note the installation and operating manual
	General note
	Wear safety footwear
	Use respiratory protection, protection class FFP 3 (particle-filtering half mask)
	Use protective gloves (cut-proof and liquid-resistant)
	Wear safety goggles with side shields
	General information

2.5 Safety instructions

Safety instructions warn against residual risks when handling the product and accessories.






These safety instructions must be strictly observed in order to prevent accidents, personal injury, damage to property and impairments during operation.

Structural design of the safety instructions:

SIGNAL WORD	Type and source of danger!
 Safety symbol	Possible consequences if the danger is ignored
	<ul style="list-style-type: none"> • Measure to prevent the danger

Signal words:

DANGER	Imminent hazard Consequences of non-compliance: Death or serious personal injury
WARNING	Imminent hazard Consequences of non-compliance: Death or serious personal injury are possible
CAUTION	Potential hazard Consequences of non-compliance: Personal injury or damage to property are possible
NOTE	Additional notes, information, tips Consequences of non-compliance: Malfunction and device failure during handling and maintenance are possible. No hazard to people or regarding the safe operation.

DANGER	Operation of plant outside the permissible limit range!
	<p>Operation of the product or accessories outside the permissible limits and operating parameters, unauthorised interference and modifications may result in death or serious injury.</p>
	<ul style="list-style-type: none"> • For safe operation of the product and accessories, always adhere to the limit values, operating parameters and maintenance intervals as well as the set-up and ambient parameters specified on the type plate and in the manual. • Inspect whether the operating parameters have been amended or restricted by the use of accessories.
DANGER	Pressurised system!
	<p>Death or serious personal injury can result through contact with fast or suddenly escaping compressed gas or through bursting system parts.</p>
	<ul style="list-style-type: none"> • All work on the compressed gas system must be carried out in the depressurised state and with the compressed gas system secured against unintentional pressure build-up. • Set up a safety area around the working area during all assembly, installation, maintenance and repair work. • Before building up pressure in the pipework, check all pipe connections and tighten if necessary. • Slowly pressurise the system with pressure. • Avoid pressure blows and high differential pressures. • Assemble all pipelines without stress. • Avoid any vibrations occurring in the pipe network by using vibration dampers.
DANGER	Electric voltage!
	<p>There is a danger of death or serious injuries following contact with components which are in contact with electric voltage. Malfunction and device failure as well as material damage can occur.</p>
	<ul style="list-style-type: none"> • The product and the accessories may only be connected to the current supply if they are undamaged. • Only carry out installation, maintenance and repair work on the product and accessories when they have been disconnected and secured against being switched back on again. • Set up a safety area around the working area during all installation, maintenance and repair work. • Only operate the product and accessories with the cover or housing complete and closed.
DANGER	Use of incorrect spare parts, accessories or materials!
	<p>The use of incorrect spare parts, accessories or materials, as well as auxiliary and operating materials, may result in death or serious injury. Malfunction and device failure as well as material damage can occur.</p>
	<ul style="list-style-type: none"> • For all work, only use undamaged original parts, auxiliary and operating materials which are specified by the manufacturer. • Use only the approved materials and suitable tools for the respective purpose and make sure that they are in proper working order. • Only use cleaned pipes that are free of dirt and corrosion.
CAUTION	Polluted condensate!
	<p>Contact with condensate containing substances which endanger health and the environment can pose a health hazard, causing irritation and/or damage to the eyes, skin and mucous membranes. Polluted condensate must be prevented from entering the sewerage system, waters or the ground.</p>
	<ul style="list-style-type: none"> • Use personal protective equipment. • Pick up and dispose of any escaped or spilled condensate in line with local regulations.

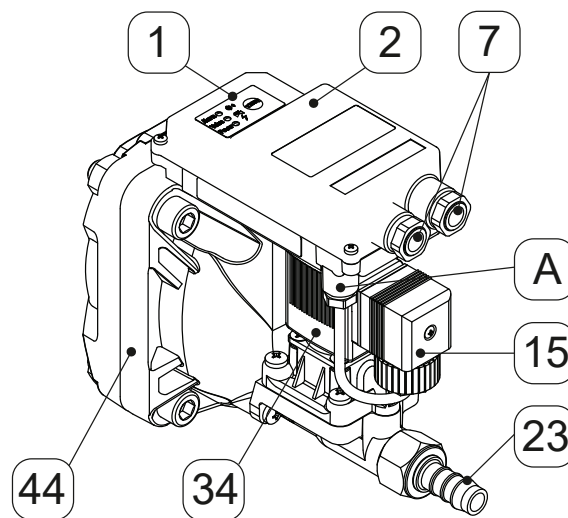
3. Product information

3.1 Product description

The **BEKOMAT®** is an electronically level-controlled condensate drain used for draining off condensate in compressed gas systems.

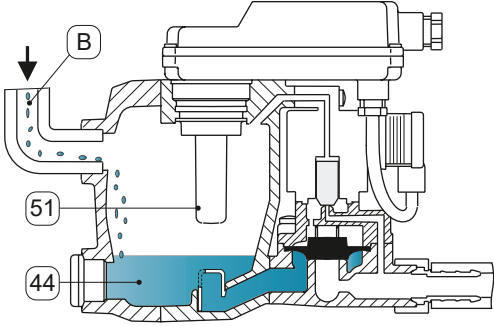
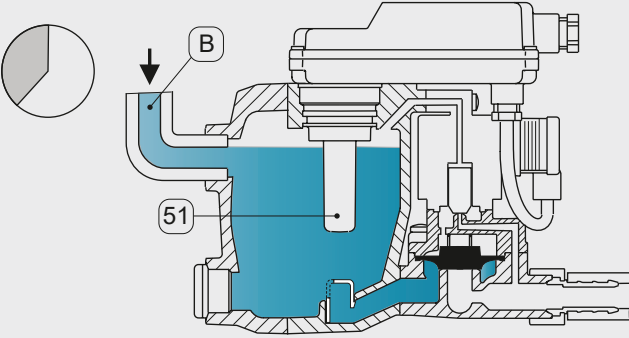
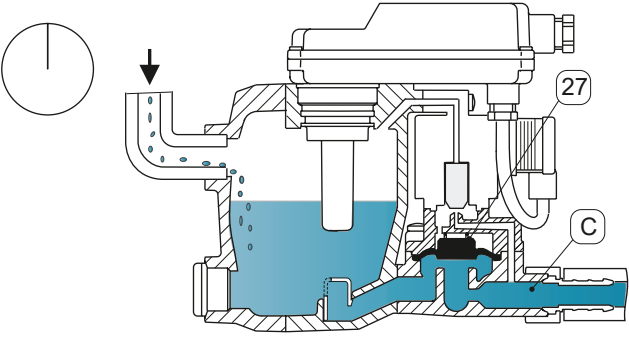
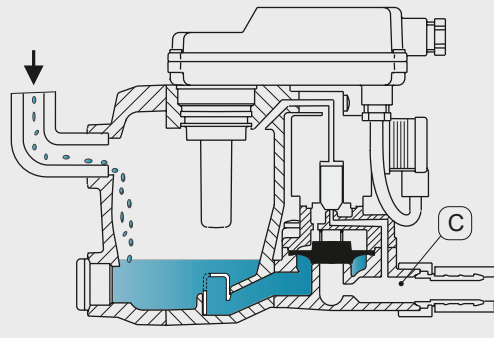
The condensate formed is collected in the **BEKOMAT®** and the filling level is monitored by an integrated capacitive sensor. When the defined filling level is reached, the condensate is discharged via a pilot-controlled solenoid valve.

3.2 Product overview



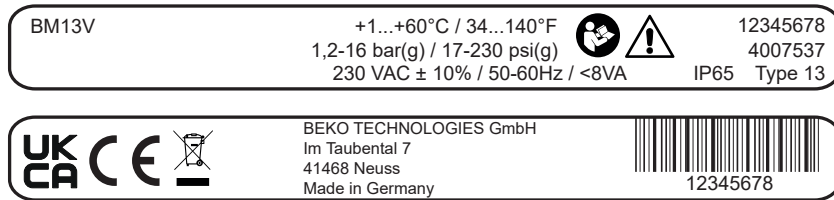
Item	Description / explanation	Item	Description / explanation
[1]	Operating label with TEST button	[15]	Solenoid valve connector
[2]	Top cover	[23]	Hose connector
[7]	Cable glands right: Voltage supply left: potential-free contact	[34]	Solenoid valve
[A]	Cable gland solenoid valve	[44]	Housing

3.3 Function description

Illustration	Description / explanation
	<p>The condensate flows via the condensate inlet [B] into the BEKOMAT® and collects in the housing [44]. The filling level in the housing [44] is permanently monitored by a capacitive sensor in the sensor tube [51].</p>
	<p>As soon as the condensate level reaches the filling level and thus the capacitive sensor [51], the preset delay time starts.</p> <p>During this time, condensate continues entering and fills the BEKOMAT® and then fills the inlet section [H] above the BEKOMAT®.</p>
	<p>After the delay time has elapsed, the pilot valve is switched and the area above the valve diaphragm is vented. The membrane [27] opens the condensate discharge [C] for condensate drainage.</p> <p>All condensate is released.</p>
	<p>Once the BEKOMAT® has been emptied completely, the condensate discharge [C] is closed tightly again before any loss of compressed gas can occur.</p>

3.4 Type plate

The type plate is located on the housing and contains all the identification and operating parameters of the **BEKOMAT®**. If you contact the manufacturer or supplier, always have this data at hand to identify your system.



Example illustrations

Position on type plate	Description / explanation
BM13V	Product name
1,2 ... 16 bar / 17 ... 230 psig	Operating temperature
+1° ... +60°C / 34° ... 140 °F	Operating pressure
230 Vac ± 10% / 50-60Hz/ <8VA	Operating voltage
4007537	Order reference
12345678	Serial number
IP65	IP degree of protection

NOTE	Handling the type plate!
	Never damage, remove or make the type plate illegible.

For more information regarding the symbols, refer to **“2.4 Explanation of the symbols used” on Page 8.**

3.5 Scope of delivery

The table below shows the scope of delivery of the **BEKOMAT®**:

Illustration	Description / explanation
	BEKOMAT®
	Original installation and operation manual

4. Technical data

4.1 Operating parameters

BEKOMAT®	13 Vario	13 Vario CO
Min. / max. operating pressure	0.8 ... 16 bar(g) 12 ... 230 psi(g)	
Min./max. operating temperature	+1 ... +60 °C +34 ... +140 °F	
Min./max. ambient temperature:	+1 ... +60 °C +34 ... +140 °F	
Min./max. ambient air humidity	10 ... 80 %, non-condensing	
Condensate inlet	2 x G1/2 (internal thread) 2 x 1/2" NPT (internal thread)	
Condensate discharge	G1/2 (internal thread)	
Media	Condensate, oil-contaminated	Condensate, oil-contaminated + oil-free
Empty weight	2.0 kg 4.4 lbs	
Operating voltage	230 / 115 / ... / 24 VAC ± 10%, 50 ... 60 Hz / 24 VDC ± 10% See type plate	
Power consumption	P < 8.0 VA (W)	
Fuse protection	recommended for AC: 1 A (time-lag) prescribed for DC: 1 A (time-lag)	
Recommended cable diameter	5.8 ... 8.5 mm 0.23 ... 0.34 inch	
Recommended wire cross-section (voltage supply)	3 x 0.75 ... 1.5 mm ² AWG 16 ... 18	
Recommended shortening of the cable jacket	PE= ~ 60 mm ~ 2.3 inch L N= ~ 50 mm ~ 1.96 inch	
Recommended stripping length of the cable wires	~ 6 mm ~ 0.24 inch	
Connection data potential-free contact for switching load	AC: max. 250 V / 1A DC: max. 30 V / 1A	
Degree of protection	IP65 / NEMA 13	
Overvoltage category	II	
Degree of pollution	3	

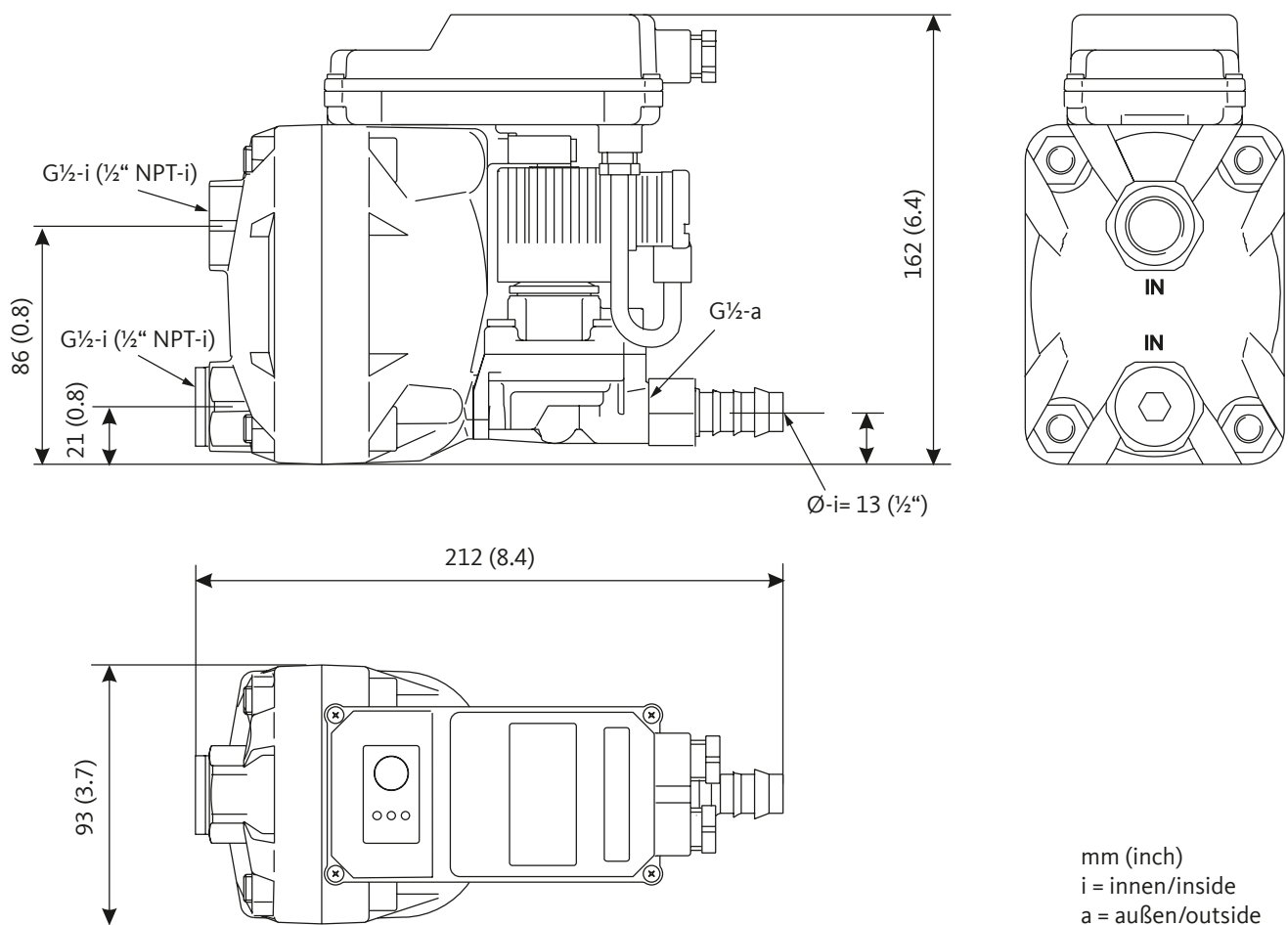
4.2 Storage and transport parameters

BEKOMAT®	13 Vario	13 Vario CO
Min. / max. storage and transport temperature		+1 ... +60 °C +34 ... +140 °F

4.3 Materials

BEKOMAT®	13 Vario	13 Vario CO
Housing	Aluminium	Aluminium, hardcoated
Membrane	FKM	

4.4 Dimensions



4.5 Installation dimensions

Illustration	Description / explanation
	<p>At the place of installation, allow sufficient assembly space above the top cover so that the LEDs are visible and the TEST button can be pressed.</p>

4.6 Terminal diagrams





4.6.1 Power control board

Illustration VAC board	Illustration VDC board											
<table border="1" style="margin-left: 20px;"> <tr><td>Normally Open (NO)</td></tr> <tr><td>Common (CO)</td></tr> <tr><td>Normally Closed (NC)</td></tr> </table> <table border="1" style="margin-left: 20px;"> <tr><td>Protective earth conductor (PE)</td></tr> <tr><td>Neutral conductor (N)</td></tr> <tr><td>Phase (L)</td></tr> </table>	Normally Open (NO)	Common (CO)	Normally Closed (NC)	Protective earth conductor (PE)	Neutral conductor (N)	Phase (L)	<table border="1" style="margin-left: 20px;"> <tr><td>Normally Open (NO)</td></tr> <tr><td>Common (CO)</td></tr> <tr><td>Normally Closed (NC)</td></tr> </table> <table border="1" style="margin-left: 20px;"> <tr><td>24V+</td></tr> <tr><td>24V-</td></tr> </table>	Normally Open (NO)	Common (CO)	Normally Closed (NC)	24V+	24V-
Normally Open (NO)												
Common (CO)												
Normally Closed (NC)												
Protective earth conductor (PE)												
Neutral conductor (N)												
Phase (L)												
Normally Open (NO)												
Common (CO)												
Normally Closed (NC)												
24V+												
24V-												

4.6.2 Control PCB

Illustration																							
	<table border="1" style="margin-left: 20px;"> <tr><td>1.0</td><td>+24V</td><td rowspan="3">Voltage supply from the power control board</td></tr> <tr><td>1.1</td><td>0V</td></tr> <tr><td>2.0</td><td>OT1</td></tr> <tr><td>2.1</td><td style="text-align: center;"> </td><td>not assigned</td></tr> <tr><td>2.2</td><td>INP1</td><td rowspan="2">External test button</td></tr> <tr><td>2.3</td><td>0V</td></tr> <tr><td>3.0</td><td>0V</td><td rowspan="3">Solenoid valve</td></tr> <tr><td>3.1</td><td>+24V</td></tr> <tr><td>3.2</td><td>OT2</td></tr> </table>	1.0	+24V	Voltage supply from the power control board	1.1	0V	2.0	OT1	2.1	 	not assigned	2.2	INP1	External test button	2.3	0V	3.0	0V	Solenoid valve	3.1	+24V	3.2	OT2
1.0	+24V	Voltage supply from the power control board																					
1.1	0V																						
2.0	OT1																						
2.1	 	not assigned																					
2.2	INP1	External test button																					
2.3	0V																						
3.0	0V	Solenoid valve																					
3.1	+24V																						
3.2	OT2																						

5. Transport and storage

WARNING	Insufficient qualification!
	Insufficient qualification of the personnel can lead to accidents, personal injury and damage to the device as well as impairments in operation during work on the product.
	The work on the product described below may only be executed and documented by skilled technical personnel - transport and storage.
CAUTION	Inappropriate transport or storage!
 	Inappropriate transport or storage may result in personal injury or damage to the device.
	<ul style="list-style-type: none"> • Wear protective gloves when working with packaging material • Use personal protective equipment, inspect it regularly for faultlessness and functionality and replace damaged parts immediately. • Handle packaging and product with care. • Pack all parts impact-proof using suitable material. • Transport and handle the packaging according to the markings (observe lifting gear attachment points, the centre of gravity and orientation e.g. keep vertical, do not throw etc.). • Use proper means of transport and lifting equipment that is in proper working order. • Always adhere to the specified transport and storage parameters. • Store the product only outside of areas exposed to direct sunlight and heat sources.
NOTE	Handling packaging material!
	Inappropriate disposal of packaging materials can cause environmental damage.
	<ul style="list-style-type: none"> • Dispose of the packaging material in accordance with the regional laws, provisions, guidelines and regulations of the country and place of use.

5.1 Transport

After transporting and removing the packaging material, inspect the product for possible transport damage. If you detect such damage, immediately notify the carrier company and **BEKO TECHNOLOGIES GMBH** or one of its agents.

Transport the product as follows:

- Only transport the product packaged.
- Handle packaging and the product with care.
- Note the transport weight specification and marking on the packaging.
- Secure the packaging and the product against slipping and falling during transport.





5.2 Storage

Store the product and the accessories as follows:

- Adhere to the storage conditions in chapter **“4.2 Storage and transport parameters” on Page 15.**
- Store in a closed, dry as well as frost-free room.
- Store protected from external influences of the weather, direct sunlight and sources of heat.
- Secure against falling over and protect against vibrations at the storage location.

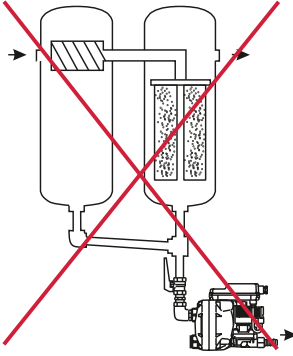
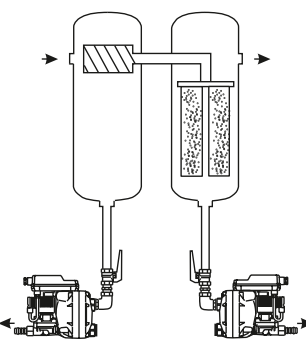

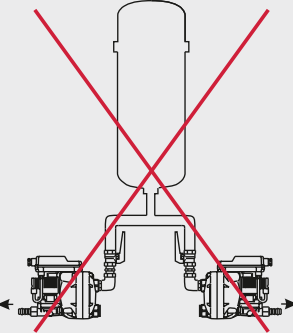
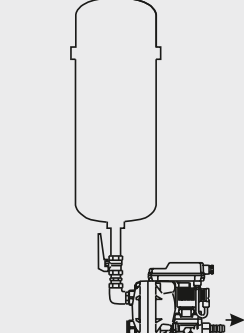

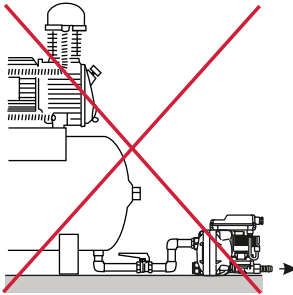
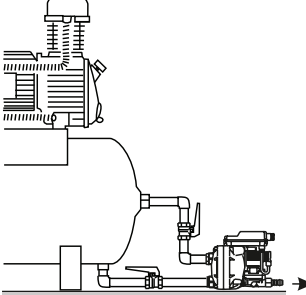

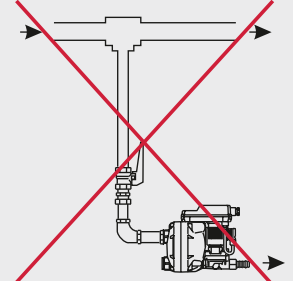
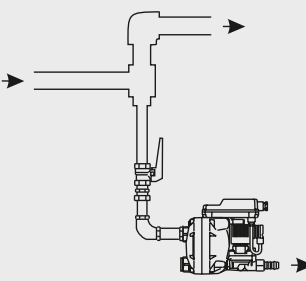

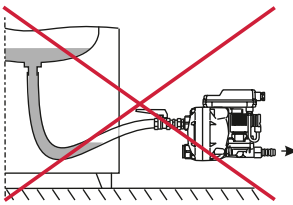
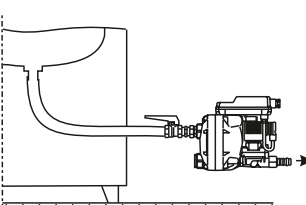

6. Assembly

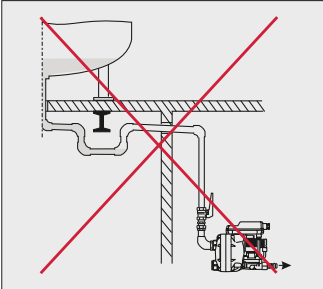
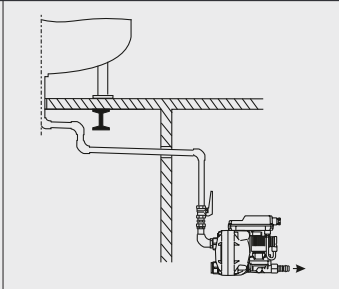

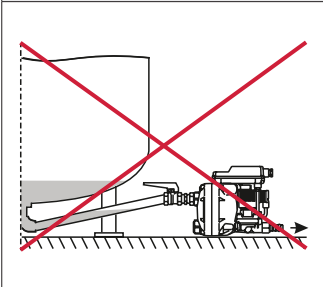
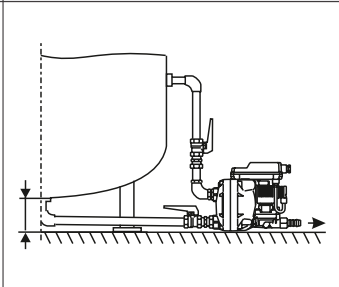

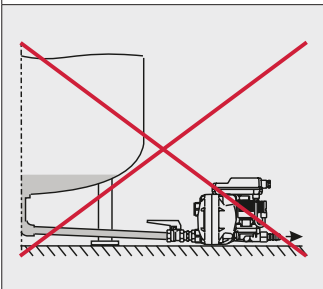
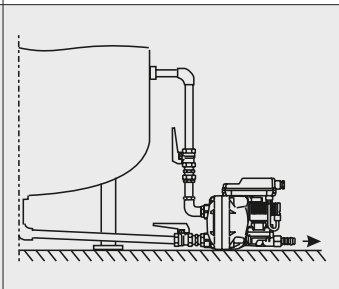

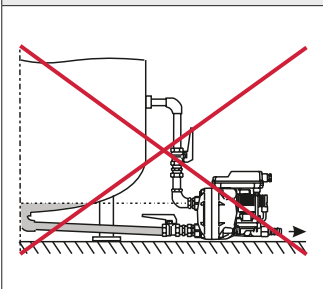
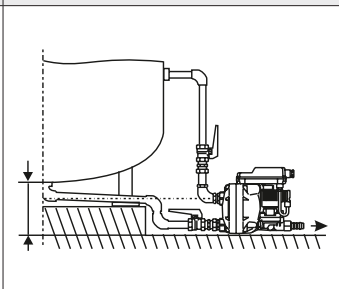

6.1 Warning notices

DANGER	Use of incorrect spare parts, accessories or materials!
	<p>The use of incorrect spare parts, accessories or materials, as well as auxiliary and operating materials, may result in death or serious injury. Malfunction and device failure as well as material damage can occur.</p> <ul style="list-style-type: none"> • For all work, only use undamaged original parts, auxiliary and operating materials which are specified by the manufacturer. • Use only the approved materials and suitable tools for the respective purpose and make sure that they are in proper working order. • Only use pipes that are free of dirt, damage and corrosion.
DANGER	Pressurised system!
	<p>Death or serious personal injury can result through contact with fast or suddenly escaping compressed gas or through bursting system parts.</p> <ul style="list-style-type: none"> • All work on the compressed gas system must be carried out in the depressurised state and with the compressed gas system secured against unintentional pressure build-up. • Set up a safety area around the working area during all assembly, installation, maintenance and repair work. • Before building up pressure in the pipework, check all pipe connections and tighten if necessary. • Slowly pressurise the system with pressure. • Avoid pressure blows and high differential pressures. • Assemble all pipelines without stress. • Install pipes tightly as feed and drain lines.
WARNING	Insufficient qualification!
	<p>Insufficient qualification of the personnel carrying out work on the product and accessories can lead to accidents, personal injury and damage to property as well as impair operation.</p> <ul style="list-style-type: none"> • All work on the product and accessories may only be carried out by skilled technical personnel - compressed gas technology.
CAUTION	Inappropriate assembly!
	<p>Inappropriate assembly of the product and the accessories can lead to personal injury and damage to property as well as impair operation.</p> <ul style="list-style-type: none"> • Fix hoses in such a way that they do not flap around.

6.1.1 General assembly instructions


Note the following assembly instructions at all times.

Wrong	Right	Description / explanation
		 <p>Bypassing the filter! Drain each point where condensate occurs separately in order to avoid bypassing the filters!</p>
		 <p>Avoid pressure ranges! Drain each point where condensate occurs using a BEKOMAT® to avoid pressure ranges in the pipework!</p>
		 <p>Ensure sufficient venting! If the gradient in the inflow is not sufficient or there are other problems with the inflow, a venting line must be laid!</p>
		 <p>Deflecting surface! In the case of direct drainage from the compressed gas line a deflection of the compressed gas flow is necessary!</p>
		 <p>Continuous slope! If a pressure hose is used for inflow, avoid the formation of a water pocket!</p>

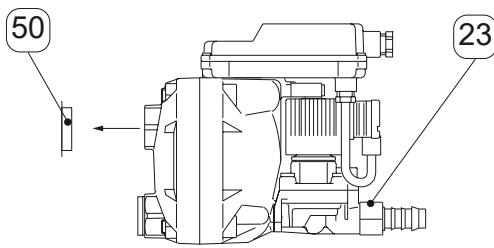
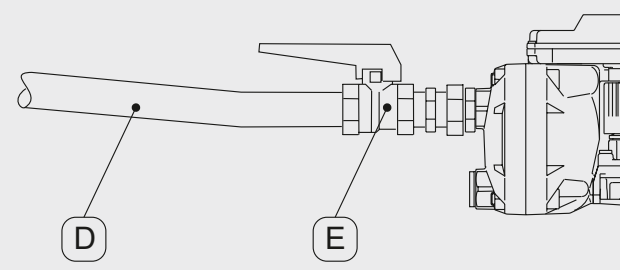
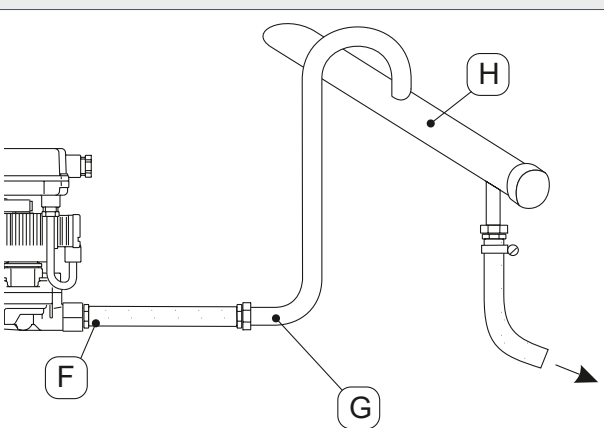
Wrong	Right	Description / explanation
		 <p>Continuous slope! When laying pipes for the feed line, avoid the formation of a water pocket.</p>
		 <p>Continuous slope! Lay the condensate inlet line with a continuous slope! If the installation height is limited, mount the lower inlet with a separate venting line.</p>
		 <p>Ensure sufficient venting! Large condensate quantities require installation of a separate venting line.</p>
		 <p>Note the minimum height of installation! The height of the condensate inlet must be located lower than the lowest point of the collecting tank (e.g. vessel).</p>

6.2 Installation

For assembly work to be carried out, the following prerequisites must be fulfilled and the preparatory tasks must have been completed.





Prerequisites		
Tools	Material	Protective equipment
<ul style="list-style-type: none"> e.g. adjustable spanner 	<ul style="list-style-type: none"> Sealants Feed line and discharge line 	Always to be worn: 

Preparatory tasks	
1.	Depressurise the compressed gas system or the respective system section and secure it against unintentional pressure build-up.
2.	Note the specified assembly instructions at all times.

Illustration	Description / explanation
	<ol style="list-style-type: none"> Remove the dust cap [50]. Screw the enclosed hose connection [23] to the condensate discharge.
	<p>Assembly instructions</p> <ul style="list-style-type: none"> The gradient of the condensate inlet line [D] must be $\geq 3\%$. Do not mount any filters in the condensate inlet line [D]. The diameter of the condensate inlet line [D] must be $\geq 1/2"$ (inner diameter ≥ 13 mm (0.5")). Recommendation: Equip the condensate inlet line [D] with a shut-off valve [E] to make simple product maintenance possible. <ol style="list-style-type: none"> For the condensate inlet line [D] apply sealant to the end of the pressure-resistant pipe and screw in at the condensate inlet.
	<p>Assembly instructions</p> <ul style="list-style-type: none"> The condensate discharge line [G] may be laid rising by max. 5 m (17 ft). The minimum pressure required increases by 0.1 bar (1.5 psi) per metre of incline. The diameter of the manifold [H] must be $\geq 3/4"$ and the gradient $\geq 3\%$. Do not use shut-off valves in the condensate discharge. Do not kink or block the pressure hose [F], or route it across storage or transport areas. <ol style="list-style-type: none"> For the drain, connect a short pressure hose [F] (designed for the system pressure) to the condensate discharge and the condensate discharge line [G] using a hose clamp.


7. Electrical installation

7.1 Warning notices

DANGER	Use of incorrect spare parts, accessories or materials!
	<p>The use of incorrect spare parts, accessories or materials, as well as auxiliary and operating materials, may result in death or serious injury. Malfunction and device failure as well as material damage can occur.</p> <ul style="list-style-type: none"> • For all work, only use undamaged original parts, auxiliary and operating materials which are specified by the manufacturer. • Use only the approved materials and suitable tools for the respective purpose and make sure that they are in proper working order.
DANGER	Electric voltage!
	<p>There is a danger of death or serious injuries as well as malfunction and device failure following contact with components which are in contact with electric voltage.</p> <ul style="list-style-type: none"> • Only carry out installation, maintenance and repair work on the product and accessories when they have been disconnected and secured against being switched back on again. • Set up a safety area around the working area during all installation, maintenance and repair work. • For installation of the device, adhere to all applicable regulations (e.g. VDE 0100 / IEC 60364/ ATEX). • Connect the protective conductor (earth connection) according to regulations.
WARNING	Insufficient qualification!
	<p>Insufficient qualification of the personnel carrying out work on the product and accessories can lead to accidents, personal injury and damage to property as well as impair operation.</p> <ul style="list-style-type: none"> • All work on the product and the accessories may only be carried out by skilled technical personnel - electrical engineering.
CAUTION	Inappropriate electrical installation!
	<p>Inappropriate electrical installation of the product and the accessories can lead to personal injury and damage to property as well as impair operation.</p> <ul style="list-style-type: none"> • Check all plug-type connections for a correct fit. • Avoid stumbling hazard through appropriate cable routing. • Avoid mechanical load on the cables through appropriate cable routing.

7.2 Connection work

For connection work to be carried out, the following prerequisites must be fulfilled and the preparatory tasks must have been completed.

Prerequisites		
Tools	Material	Protective equipment
<ul style="list-style-type: none"> Stripping tool Crimping tool for wire-end ferrules Screwdriver – cross-head, size 2.5 mm (0.09") Screwdriver - flat-blade size 2.5 mm (0.09") 	<ul style="list-style-type: none"> 3-wire cable for voltage supply 230 V 2-wire cable for voltage supply 24 V 2-wire cable for external test 2/3-wire cable for potential-free contact (depending on the application) Wire end ferrules 	<p>Always to be worn:</p> 

Preparatory tasks	
1.	Assembly must have been completed.
2.	Protect the cables for the voltage supply of the BEKOMAT® in accordance with the specifications in the technical data. AC = 1 A (time-lag) recommended DC = 1 A (time-lag) prescribed
3.	In the case of AC voltage supply an accessible circuit breaker (e.g. power plug or switch) that shuts off all energised conductors must be installed close to the unit.

7.2.1 Voltage supply connection

7.2.1.1 Power control board AC

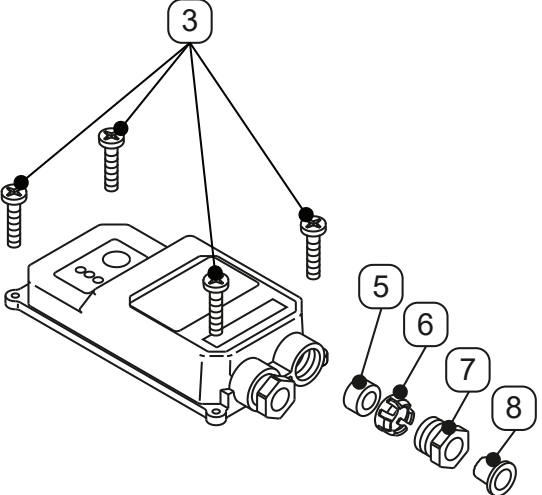
Illustration	Description / explanation
	<p>4. Loosen the 4 pan-head screws [3] in the top cover and unscrew the components of the cable gland [5, 6, 7, 8].</p>

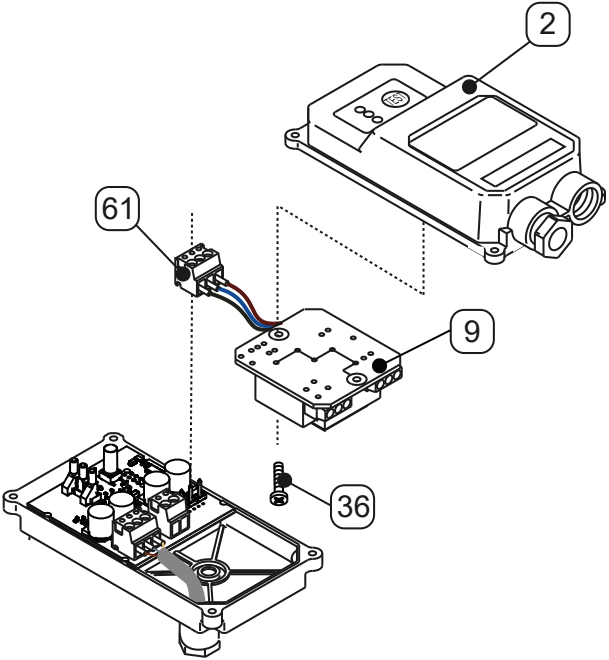
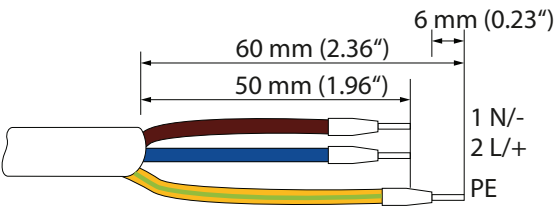
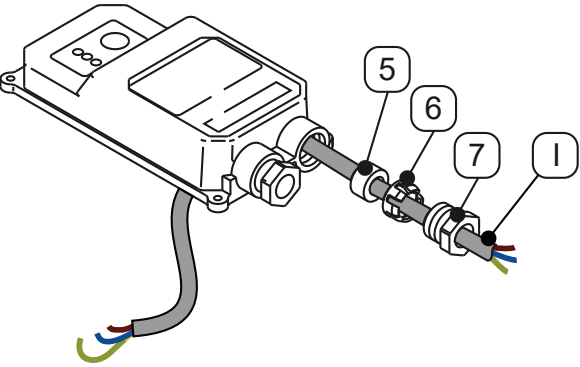
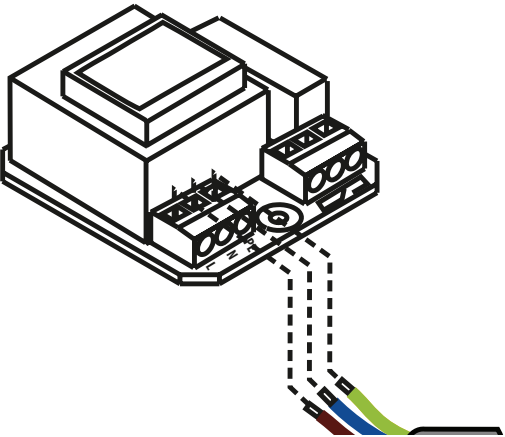
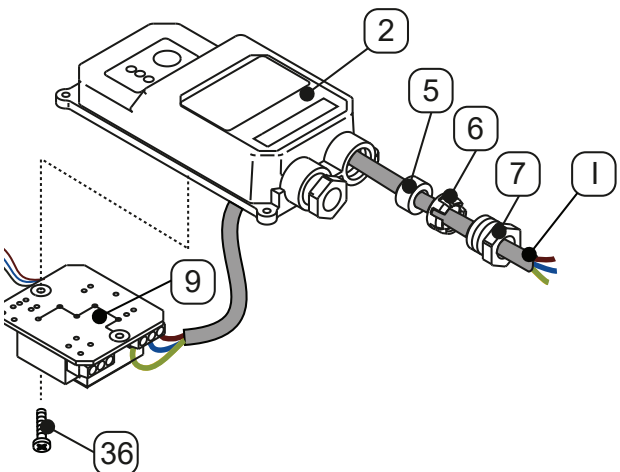
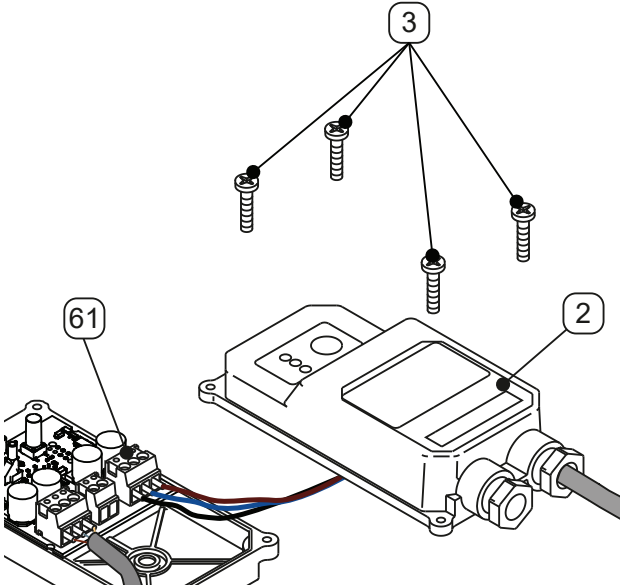
Illustration	Description / explanation
	<p>5. Raise the top cover [2] a little and pull the cable terminal [61] of the power control board up and off.</p> <p>6. Unscrew the pan-head screw [36] and take the power control board [9] out of the top cover [2].</p>
	<p>7. Prepare the 3-wire voltage supply cable.</p>
	<p>8. Slide the components of the cable gland [5, 6, 7] over the cable for voltage supply [1] and insert the cable into the top cover.</p>
	<p>9. Connect the voltage supply cable to the power control board in accordance with the terminal diagram ("4.6.1 Power control board" on Page 16).</p>

Illustration	Description / explanation
	<p>10. Insert the power control board [9] back into the top cover [2] and fasten using the pan-head screw [36]. Tighten the voltage supply cable [1] while doing this and screw the components of the cable gland [5, 6, 7] in place.</p>
	<p>11. Fit the screw terminal [61]. Set the top cover [2] in place and fix it using the pan-head screws [3].</p>

7.2.1.2 Power control board DC

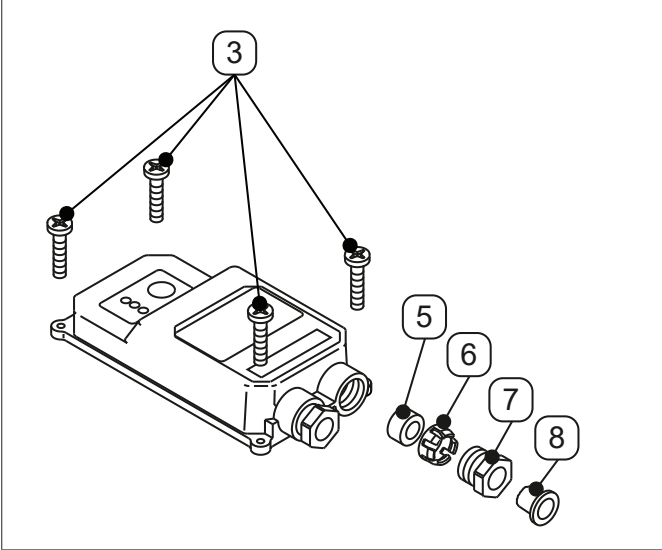
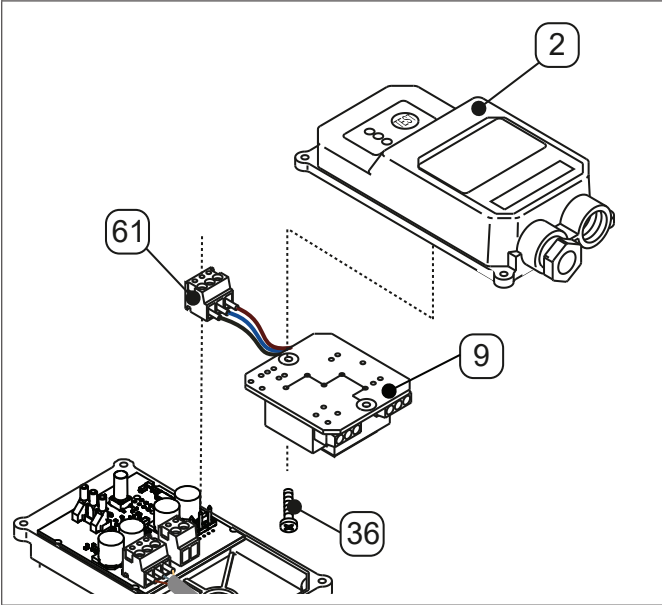
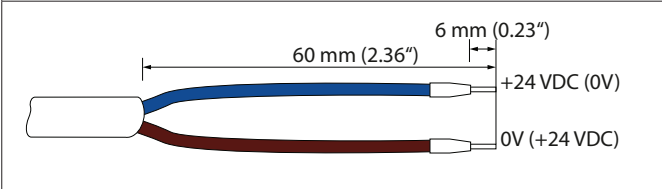
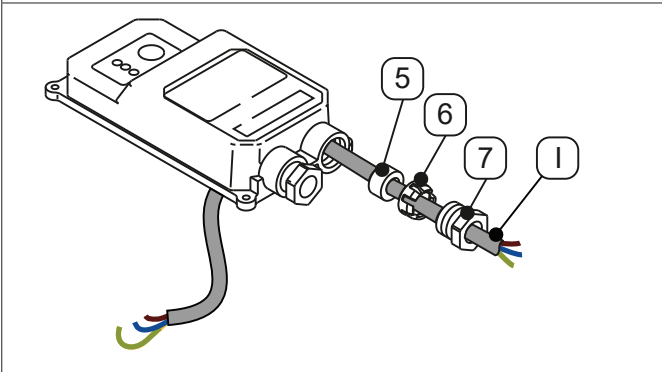
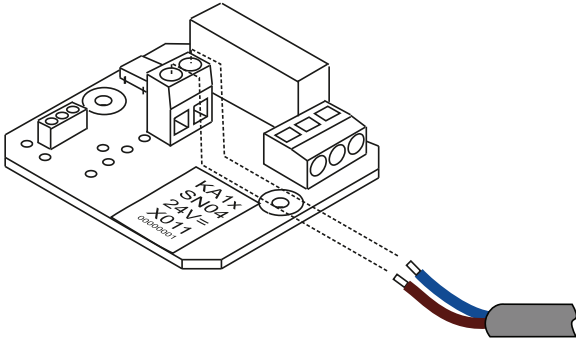
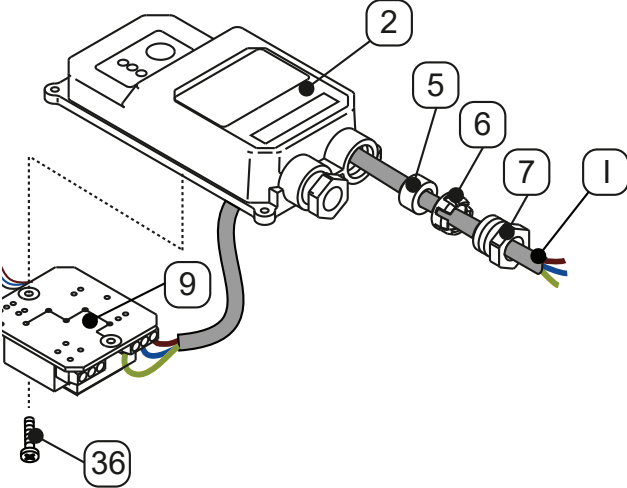
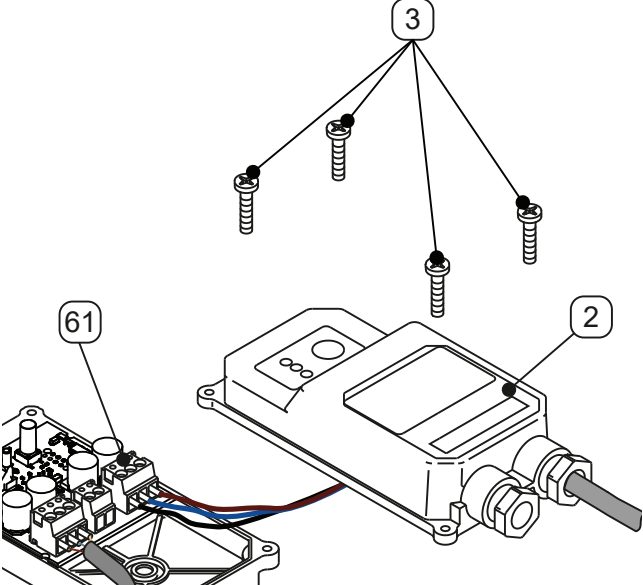
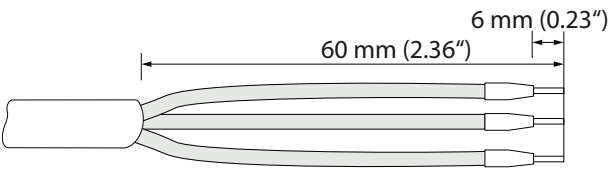

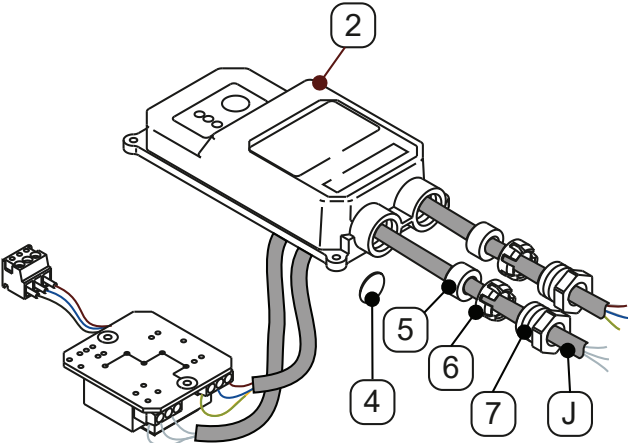
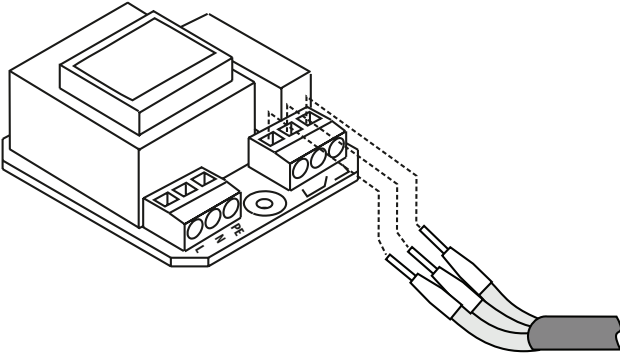
Illustration	Description / explanation
	<p>1. Loosen the 4 pan-head screws [3] in the top cover and unscrew the components of the cable gland [5, 6, 7, 8].</p>
	<p>2. Raise the top cover [2] a little and pull the cable terminal [61] of the power control board up and off. 3. Unscrew the pan-head screw [36] and take the power control board [9] out of the top cover [2].</p>
	<p>4. Prepare the 2-wire voltage supply cable.</p>
	<p>5. Slide the components of the cable gland [5, 6, 7] over the cable for voltage supply [1] and insert the cable into the top cover.</p>

Illustration	Description / explanation
	<p>6. Connect the voltage supply cable to the power control board in accordance with the terminal diagram (“4.6.1 Power control board” on Page 16).</p>
	<p>7. Insert the power control board [9] back into the top cover [2] and fasten using the pan-head screw [36]. Tighten the voltage supply cable [1] while doing this and screw the components of the cable gland [5, 6, 7] in place.</p>
	<p>8. Fit the screw terminal [61], set the top cover [2] in place and fasten using the pan-head screw [3].</p>

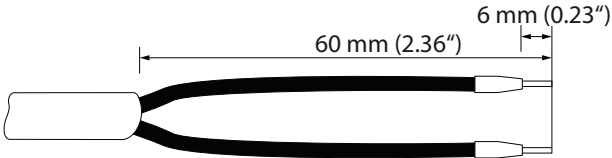

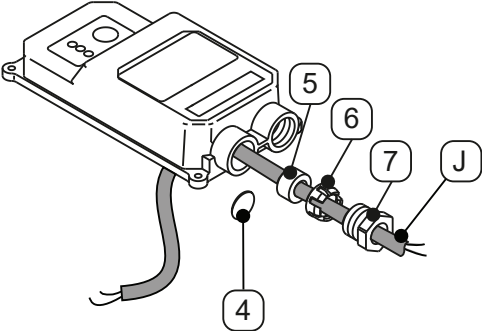
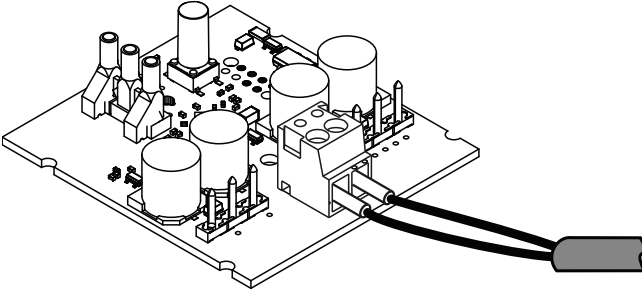
7.2.2 Connection of potential free contact

The **BEKOMAT®** has a potential-free contact on the power control board. A fault signal can be indicated at a remote maintenance centre through this.

Illustration	Description / explanation
	<ol style="list-style-type: none"> 1. Prepare the 2/3-wire cable of the potential-free contact (depending on the application). <p> If the external TEST button is to be connected in addition to the potential-free contact, a 4/5-wire cable must be used for the connection (depending on the application).</p>
	<ol style="list-style-type: none"> 2. Take the dust protection pane [4] out. 3. Slide the components of the cable gland [5, 6, 7] over the cable for potential-free contact [J] and insert the cable into the top cover.
	<ol style="list-style-type: none"> 4. Connect the cable of the potential-free contact to the power control board in accordance with the terminal diagram ("4.6.1 Power control board" on Page 16).




7.2.3 Connection of external TEST

The **BEKOMAT®** has an option for the connection of an external TEST button. This enables condensate to be discharged via remote control. If the external contact is closed, the solenoid valve opens like after pressing the TEST button on the top cover and the **BEKOMAT®** discharges condensate.

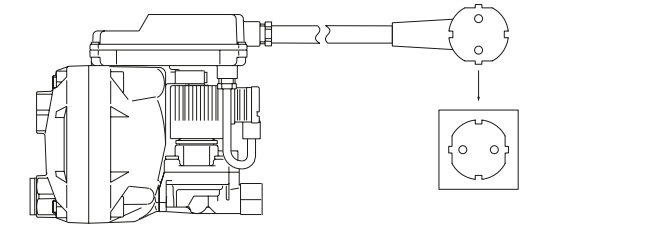
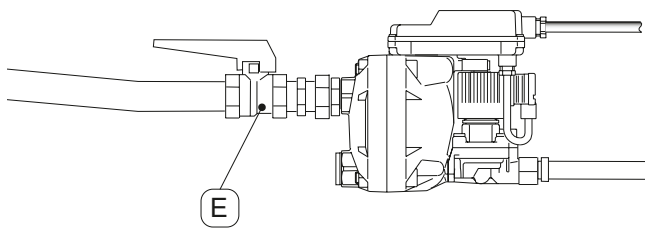
Illustration	Description / explanation
	<ol style="list-style-type: none"> 1. Prepare the external TEST button cable. <p> If the potential free contact is to be connected in addition to the external TEST button, a 4/5-wire cable must be used for the connection (depending on the application).</p>
	<ol style="list-style-type: none"> 2. Take the dust protection pane [4] out of the left-hand cable gland. 3. Slide the components of the cable gland [5, 6, 7] over the cable [J] and insert the cable into the top cover.
	<ol style="list-style-type: none"> 4. Connect the cable of the external TEST button to the control PCB in accordance with the terminal diagram ("4.6.2 Control PCB" on Page 16).

8. Commissioning

8.1 Warning notices

DANGER	Pressurised system!
	<p>Death or serious personal injury can result through contact with fast or suddenly escaping compressed gas or through bursting system parts.</p> <ul style="list-style-type: none"> • All work on the compressed gas system must be carried out in the depressurised state and with the compressed gas system secured against unintentional pressure build-up. • Set up a safety area around the working area during all assembly, installation, maintenance and repair work. • Before building up pressure in the pipework, check all pipe connections and tighten if necessary. • Slowly pressurise the system with pressure. • Avoid pressure blows and high differential pressures. • Assemble all pipelines without stress. • Install pipes tightly as feed and drain lines.
DANGER	Electric voltage!
	<p>There is a danger of death or serious injuries as well as malfunction and device failure following contact with components which are in contact with electric voltage.</p> <ul style="list-style-type: none"> • Only carry out installation, maintenance and repair work on the product and accessories when they have been disconnected and secured against being switched back on again. • Set up a safety area around the working area during all installation, maintenance and repair work. • For installation of the device, adhere to all applicable regulations (e.g. VDE 0100 / IEC 60364/ ATEX). • Connect the protective conductor (earth connection) according to regulations.
WARNING	Insufficient qualification!
	<p>Insufficient qualification of the personnel carrying out work on the product and accessories can lead to accidents, personal injury and damage to property as well as impair operation.</p> <ul style="list-style-type: none"> • All work on the product and accessories may only be carried out by skilled technical personnel - compressed gas technology.

8.2 Commissioning work

Illustration	Description / explanation
	<ol style="list-style-type: none"> 1. Supply the BEKOMAT® with voltage.
	<ol style="list-style-type: none"> 2. Slowly charge the system section with pressure. To do this, slowly open the shut-off valve [E].

9. Operation

As soon as the **BEKOMAT®** is supplied with voltage, a self-test starts automatically, during which all internal components necessary for the proper functioning of the **BEKOMAT®** are checked.

If the self-test is positive, the **BEKOMAT®** goes into normal operation.

→ For acoustic signalling, the solenoid valve cycles 2 times.

If the self-test is negative, the **BEKOMAT®** goes into fail-safe operation.

→ For acoustic signalling, the solenoid valve cycles 20 times.

The LED signalling of the various operating states can be seen in the following table.

9.1 Operating states

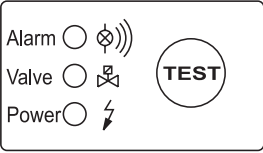
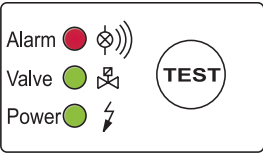
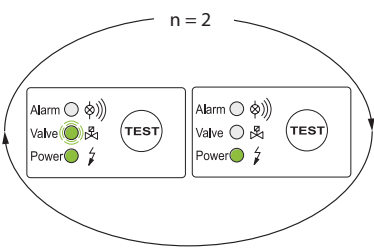
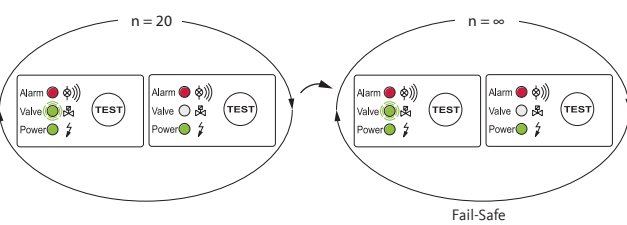
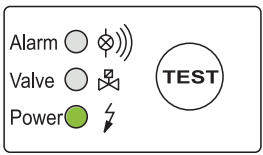
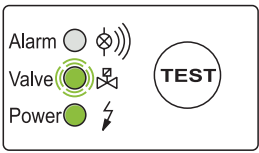
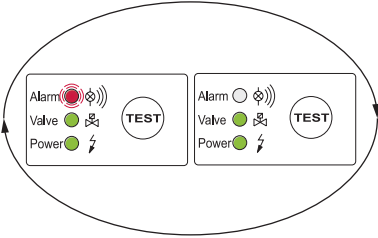
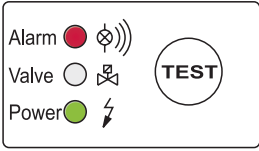
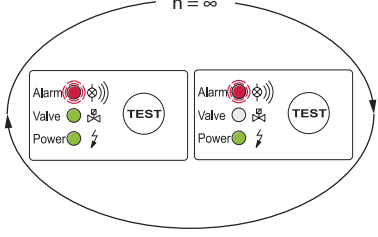




Illustration	Description / explanation
	<p>Disconnected</p> <ul style="list-style-type: none"> All LEDs are off
	<p>Switch on / power-on self-test</p> <ul style="list-style-type: none"> All LEDs light up for 1 second
	<p>Positive power-on self-test (repeat 2x)</p> <ul style="list-style-type: none"> The red Alarm LED is off The green Valve LED lights up during the solenoid valve cycles The green Power LED is on The solenoid valve cycles <p>→ goes into normal operation</p>
	<p>Negative power-on self-test (repeat 20x)</p> <ul style="list-style-type: none"> The red Alarm LED is on The green Valve LED lights up during the solenoid valve cycles The green Power LED is on The solenoid valve cycles <p>→ Goes to fail-safe operation (continuous loop)</p> <ul style="list-style-type: none"> The solenoid valve cycles once per second
	<p>Ready for operation (normal operating mode)</p> <ul style="list-style-type: none"> The red Alarm LED is off The green Valve LED is off The green Power LED is on

Illustration	Description / explanation
	<p>Discharge procedure (TEST button pressed briefly)</p> <ul style="list-style-type: none"> • The red Alarm LED is off • The green Valve LED lights up during the discharge procedure • The green Power LED is on
	<p>Pre-alarm (TEST button pressed >1 min and <5 min)</p> <ul style="list-style-type: none"> • The red Alarm LED flashes • The green Valve LED is on • The green Power LED is on
	<p>Alarm (TEST button pressed >5 min)</p> <ul style="list-style-type: none"> • The red Alarm LED is on • The green Valve LED is off • The green Power LED is on
	<p>Alarm mode (problem with condensate discharge)</p> <ul style="list-style-type: none"> • The red Alarm LED flashes • The green Power LED lights up • The green Valve LED lights up during the solenoid valve cycles • The solenoid valve sets a cycle every 4 minutes <p>→ Passes to normal mode with free condensate discharge</p>

For further information about fault indications during operation see **“15. Troubleshooting / FAQ” on Page 53.**

10. Maintenance

10.1 Warning notices


DANGER	Pressurised system!
	<p>Death or serious personal injury can result through contact with fast or suddenly escaping compressed gas or through bursting system parts.</p> <ul style="list-style-type: none"> • All work on the compressed gas system must be carried out in the depressurised state and with the compressed gas system secured against unintentional pressure build-up. • Set up a safety area around the working area during all assembly, installation, maintenance and repair work. • Before building up pressure in the pipework, check all pipe connections and tighten if necessary. • Slowly pressurise the system with pressure. • Avoid pressure blows and high differential pressures. • Assemble all pipelines without stress. • Install pipes tightly as feed and drain lines.
CAUTION	Inappropriate cleaning and use of the wrong cleaning media!
	<p>Inappropriate cleaning and the use of the wrong cleaning media may result in minor injuries as well as damage to health and property.</p> <ul style="list-style-type: none"> • Never clean the device with a dripping wet cloth. • Never use abrasive or aggressive cleaning agents or solvents which could damage the outer coating (e.g. markings, type plate, corrosion protection, etc.). • Never clean the device with hard or pointed implements. • Use an anti-static, damp cloth for cleaning the outside. • Immediately replace any product markings (pictograms, markings) that have become illegible.
WARNING	Insufficient qualification!
	<p>Insufficient qualification of the personnel carrying out work on the product and accessories can lead to accidents, personal injury and damage to property as well as impair operation.</p> <ul style="list-style-type: none"> • All work on the product and the accessories may only be carried out by skilled technical personnel - customer service.
NOTE	Local hygiene regulations!
	<p>In addition to the cleaning instructions listed, any local hygiene regulations which are in place must be heeded.</p>

10.2 Maintenance schedule

Maintenance	Interval
Wear parts exchange	Annually
Cleaning work	Annually
Visual inspection	Weekly
Leakage test	At the end of all assembly work and maintenance and servicing work on the product

10.3 Maintenance work

For maintenance work to be carried out, the following prerequisites must be fulfilled and the preparatory tasks must have been completed.

Prerequisites		
Tools	Material	Protective equipment
<ul style="list-style-type: none"> Screwdrivers: Cross-head size 2.5 mm (0.09") Flat-blade size 2.5 mm (0.09") Torx, size: TX20 e.g. adjustable spanner Cleaning brush made of wire or soft plastic material with Ø max. = 1.5 mm (0.05") Ø max. = 2.5 mm (0.09") 	<ul style="list-style-type: none"> Sealants Lubricant for greasing the O-rings Mild detergent Cotton cloth or disposable tissue 	<p>Always to be worn:</p> 

Preparatory tasks	
1.	Decommissioning and disassembly must have been completed.

10.3.1 Wear parts exchange

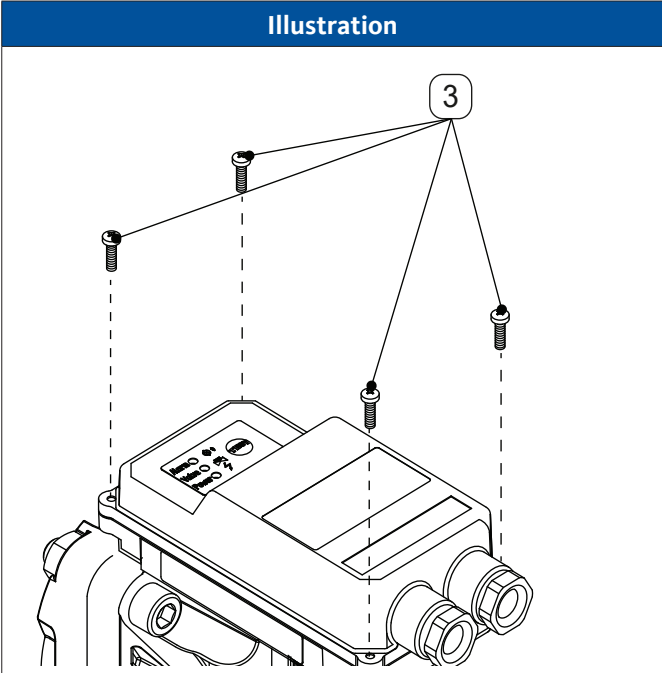
Illustration	Description / explanation
	<p>2. Loosen the 4 pan-head screws [3].</p>

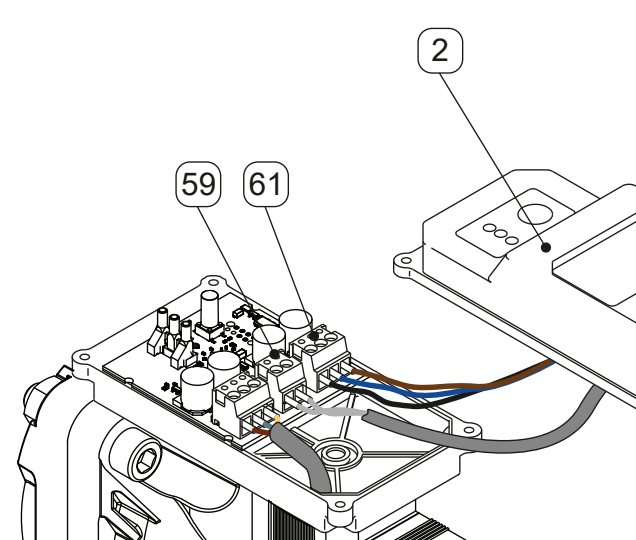
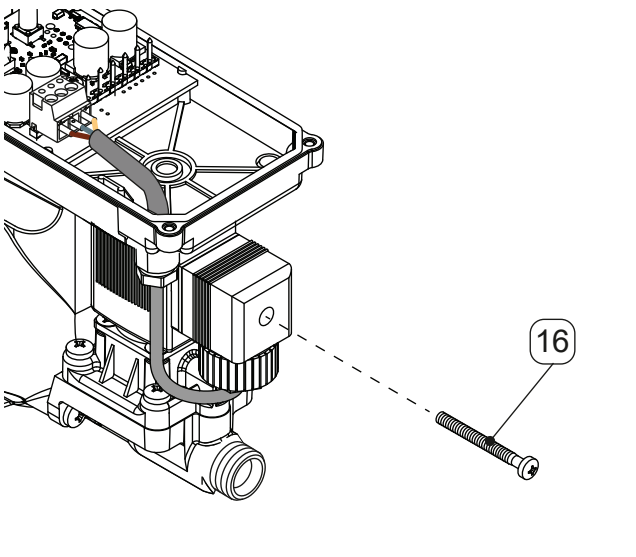
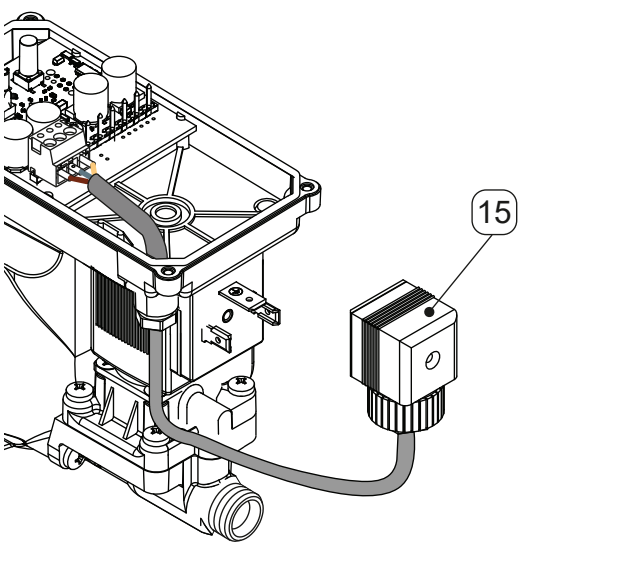
Illustration	Description / explanation
 An exploded view diagram showing the top cover (2) being lifted away from the terminal block. Two terminals, labeled 59 and 61, are shown being lifted from the terminal block. Wires are connected to the terminals and the cover.	<p>3. Raise the top cover [2] and lift the terminals [59, 61] off.</p>
 An exploded view diagram showing a screw (16) being loosened from the solenoid valve connector. The screw is shown with a dashed line indicating its position on the connector.	<p>4. Loosen the fixing screws of the solenoid valve connector [16].</p>
 An exploded view diagram showing the solenoid valve connector (15) being pulled off from the solenoid valve. The connector is shown with a dashed line indicating its position on the valve.	<p>5. Pull the solenoid valve connector [15] off.</p>

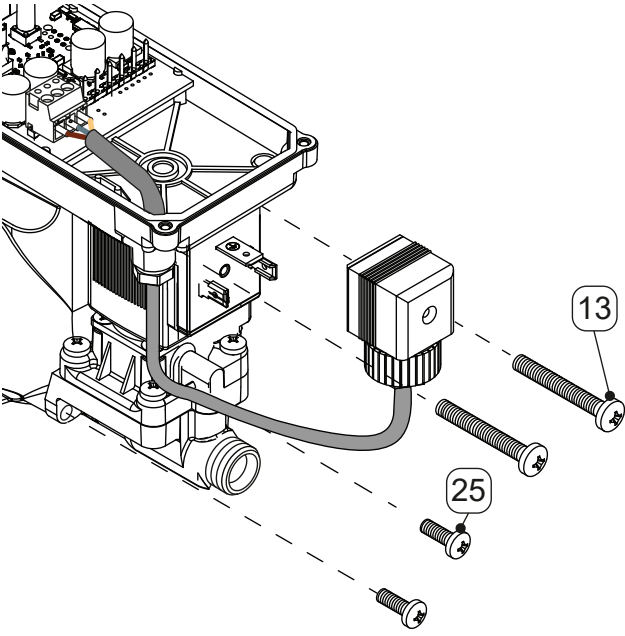
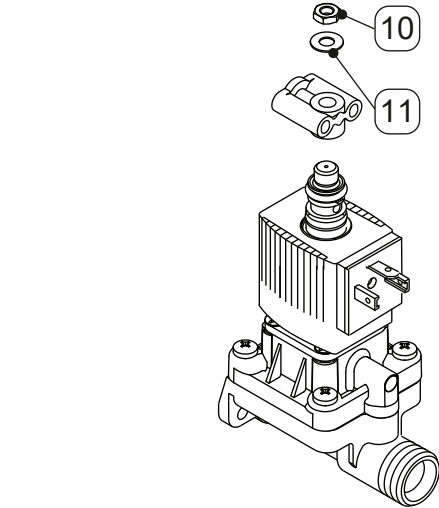
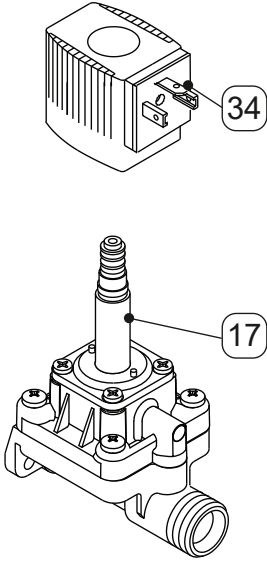
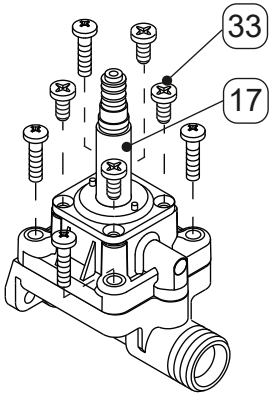
Illustration	Description / explanation
	<p>6. Loosen the pan-head screws [13] and [25] and remove the solenoid valve.</p>
	<p>7. Loosen the hexagon nut [10] and remove together with the washer [11].</p>

Illustration	Description / explanation
	<p>8. Pull the solenoid coil [34] up and off the core guide pipe [17].</p>
	<p>9. Loosen the countersunk head screws [33] and remove the core guide pipe [17].</p>



The intervals for wear part replacement and the necessary cleaning work are identical.

Recommendation:

Carry out cleaning work in the disassembled state at the same time as wear part replacement.

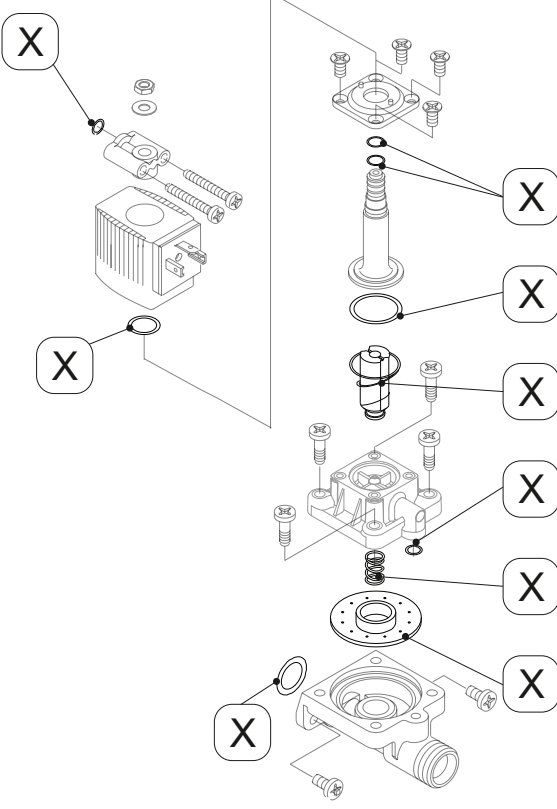
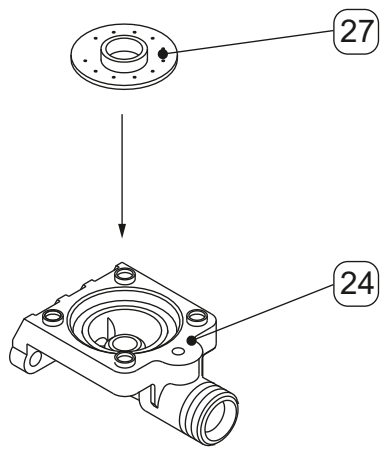
Illustration	Description / explanation
 <p>The diagram shows an exploded view of a pump assembly. On the left, a motor is shown with a component marked 'X' being attached to its shaft. To the right, the main pump housing is shown with several internal components marked 'X': a top cover, a shaft with a seal, an O-ring, a spring, a membrane seat, and a membrane. The 'X' marks indicate that these components are part of a wear parts set that must be replaced.</p>	<p>The components [X] are contained in the set of wear parts and must be replaced.</p> <p>10. Grease the O-rings in the set of wear parts. Use a lubricant suitable for this purpose.</p>
 <p>The diagram shows a circular membrane (27) being lowered into a corresponding hole in a larger component (24), which is the membrane seat. An arrow indicates the direction of movement.</p>	<p>11. Place the membrane [27] in the membrane seat [24].</p>

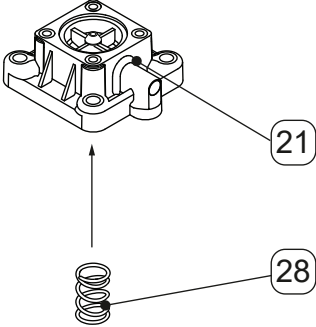
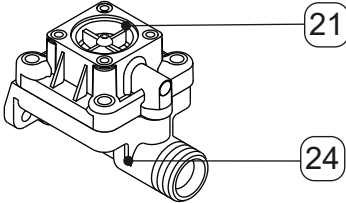
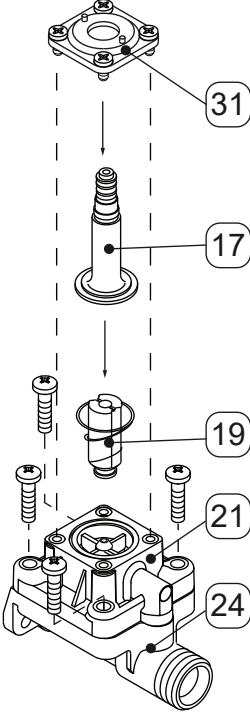
Illustration	Description / explanation
	<p>12. Insert the pressure spring [28] in the membrane cap [21].</p>
	<p>13. Place the membrane cap [21] with pressure spring [28] (not shown) onto the membrane seat [24]. Make sure that the pressure spring is fitted in the centre of the membrane.</p>
	<p>14. Insert the solenoid valve core [19] into the core guide pipe [17]. Guide the flange [31] with screws over the core guide pipe [17] and screw tightly on the membrane cap [21].</p> <p>15. Tighten the diaphragm cover [21] with the diaphragm holder [24].</p>

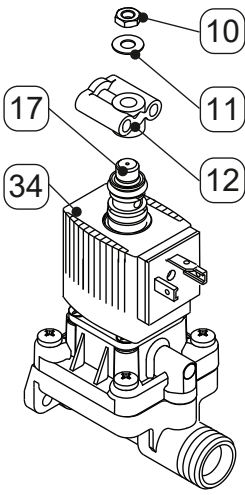
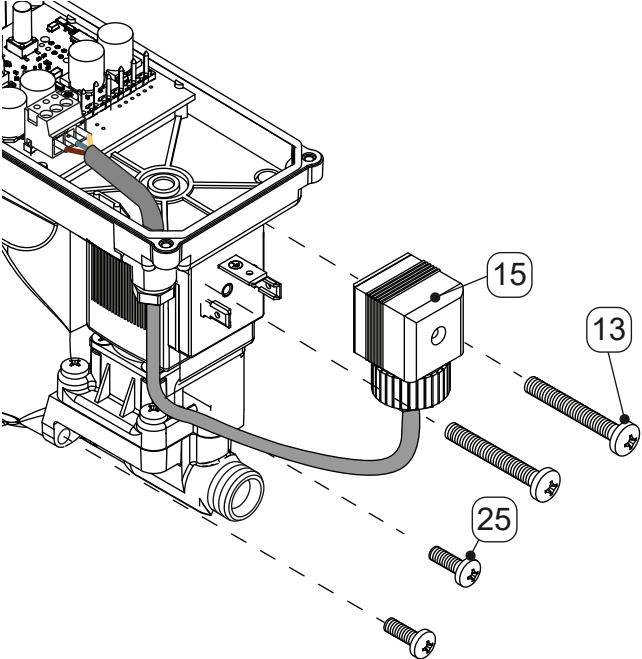
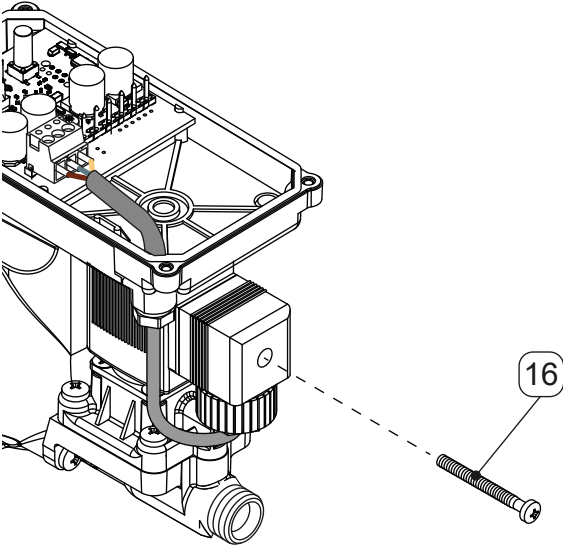
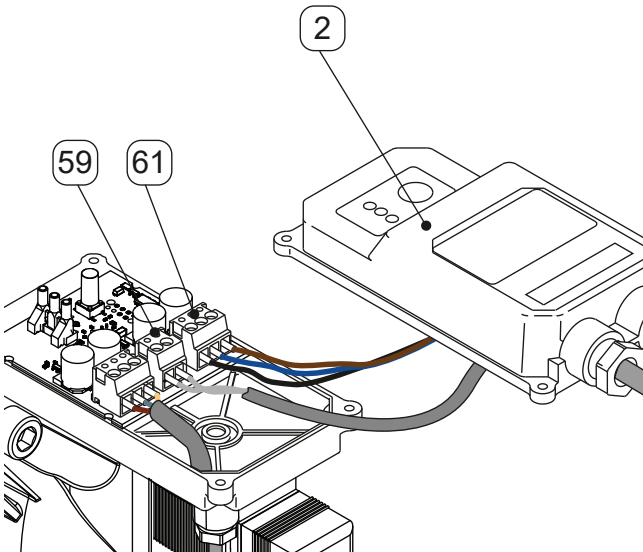
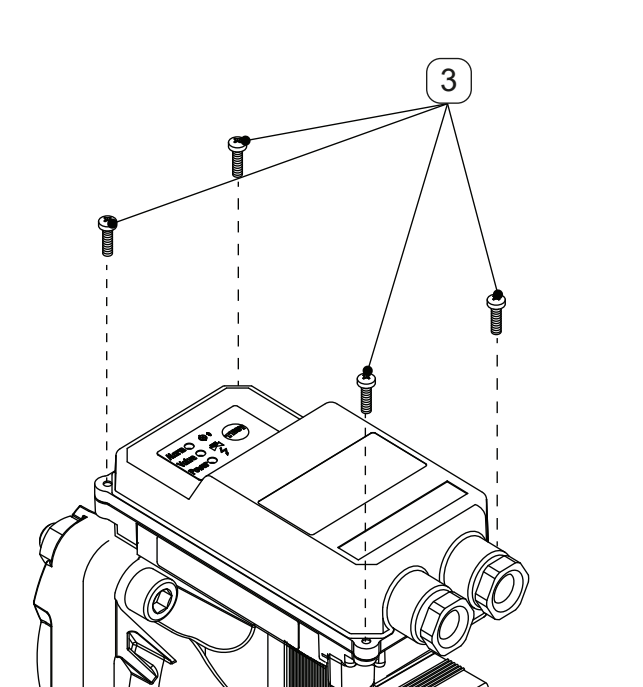
Illustration	Description / explanation
	<p>16. Insert the solenoid coil [34], the control-air cover [12] and the washer [11] onto the core guide pipe [17] and screw in place using the hexagon nut [10].</p>
	<p>17. Screw the solenoid valve to the housing again using the pan-head screws [13] and [25] and fit the solenoid valve connector [15].</p>
	<p>18. Screw the fixing screw of the solenoid valve connector [16] tight.</p>

Illustration	Description / explanation
 <p>The illustration shows a terminal block assembly with several wires connected. Two specific terminals are labeled with circled numbers 59 and 61. A separate rectangular top cover, labeled with a circled number 2, is shown being positioned over the terminal block. The cover has a small circular hole and a rectangular slot.</p>	<p>19. Fit the cable terminals [59, 61] and the top cover [2].</p>
 <p>The illustration shows the top cover from the previous step now fully attached to the terminal block. Four pan-head screws, labeled with a circled number 3, are shown being inserted into the cover and tightened. Dashed lines indicate the vertical path of each screw from the cover down to the terminal block.</p>	<p>20. Screw the 4 pan-head screws [3] tight.</p>

10.3.2 Cleaning work

Clean the **BEKOMAT®** using a damp (not dripping wet) cotton cloth or disposable wipe, a cleaning brush and a mild, conventional cleaning agent/soap.

Spray the cleaning agent on a clean cotton cloth or disposable wipe and wipe down the entire component. Then dry using a clean cloth or let it dry at room temperature.

Carry out the individual cleaning steps as follows:

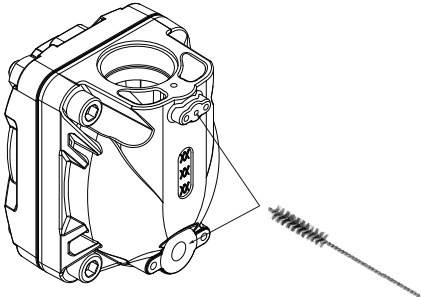
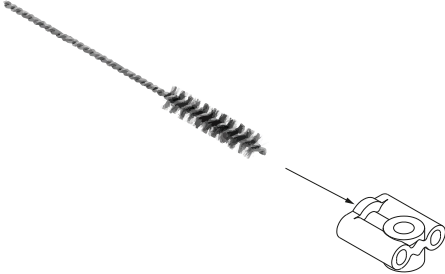
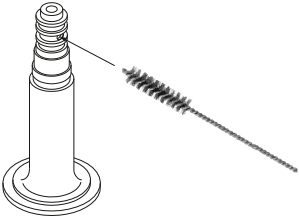
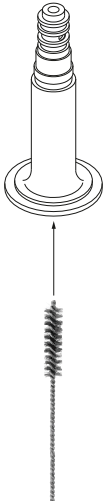
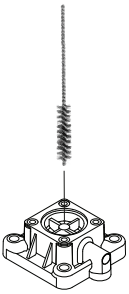
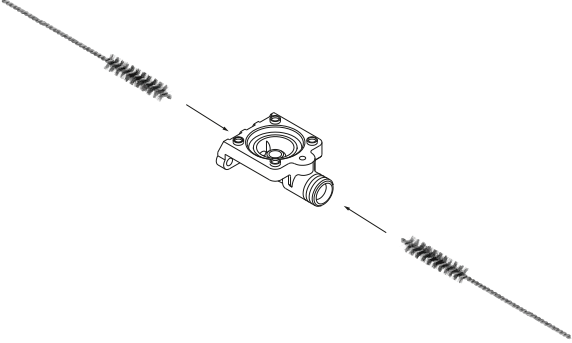
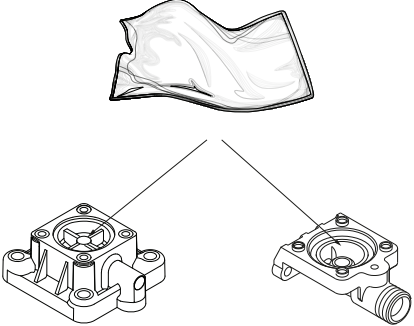
Illustration	Description / explanation
	<p>1. Clean the control-air bore and condensate discharge bore using a cleaning brush Ø max. = 2.5 mm (0.09").</p>
	<p>2. Clean the control-air cover using a cleaning brush Ø max. = 2.5 mm (0.09").</p>
	<p>3. Clean the upper opening on the core guide pipe using a cleaning brush Ø max. = 2.5 mm (0.09").</p>
	<p>4. Clean the core guide pipe from below using a cleaning brush or a clean cloth.</p>

Illustration	Description / explanation
	<p>5. Clean the membrane cap using a cleaning brush \varnothing max. = 1.5 mm (0.05").</p>
	<p>6. Clean the membrane seat using a cleaning brush \varnothing max. = 2.5 mm (0.09").</p>
	<p>7. Wipe the membrane seat and the membrane cap down using a clean cloth without cleaning agent.</p>

10.3.3 Visual inspection

During the visual inspection, check all components for mechanical damage and corrosion. Replace damaged components immediately.

10.3.4 Leakage test

The leakage test is a non-destructive test method and is used to prove leak tightness in vacuum and overpressure systems. The leakage test can be carried out in different ways. **BEKO TECHNOLOGIES GmbH** does not make a specific recommendation here. The company operating the compressed gas system is responsible for the selection and specification of the test method to be used, which should be executed in accordance with valid standards and regulations (e.g. DIN EN 1779).

11. Consumables, accessories and spare parts

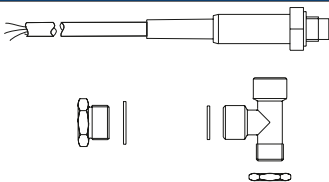
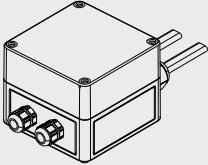
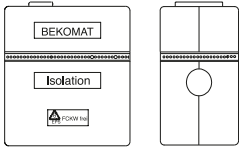
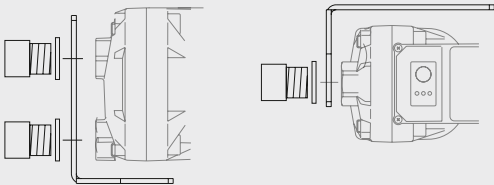
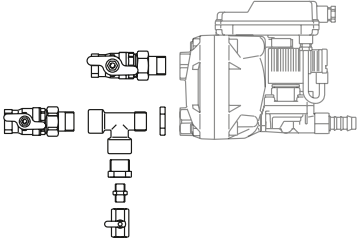
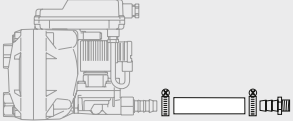
11.1 Order information

BEKO TECHNOLOGIES customer service requires the following data for an inquiry or order:

- Serial number of the product (see type plate)
- Material number and designation of the accessory or spare part
- Required quantity of accessories or spare parts to be delivered

The contact data for the BEKO TECHNOLOGIES customer services responsible are listed in chapter “1.1 Contact” on Page 4.

11.2 Accessories

Illustration	Description / explanation & order reference
	<p>Thermostatically controlled heating system 2801244 (200 ... 230 VAC) 2801245 (100 ... 115 VAC) 2801247 (24 VAC/VDC)</p>
	<p>Trace heater 230 VAC 4041657</p>
	<p>Insulation shell 2000033</p>
	<p>Mounting bracket for wall and floor installation 2000036</p>
	<p>Connection set 2000040</p>
	<p>Drain kit 2000046</p>

11.3 Spare parts

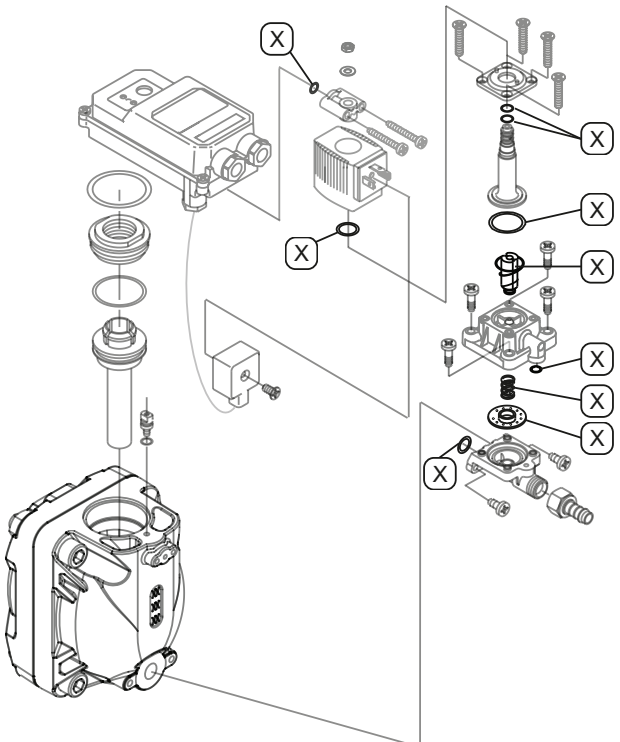
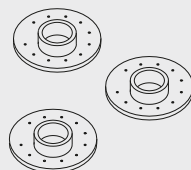
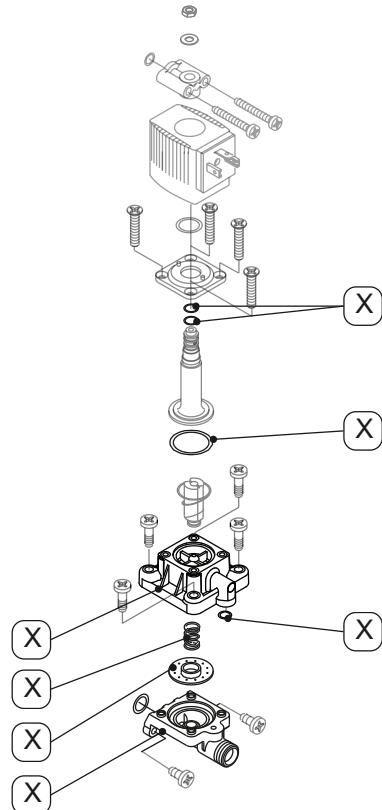
Illustration	Description / explanation & order reference
	<p>Set of wear parts 2000067</p>
	<p>Membranes, 3 pcs. 4002451</p>
	<p>Membrane seat 2001118</p>

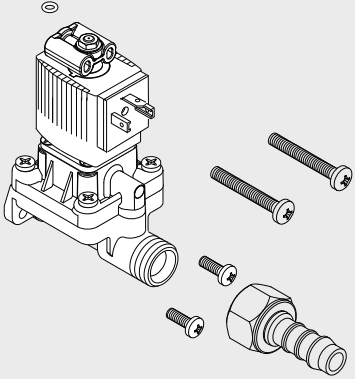
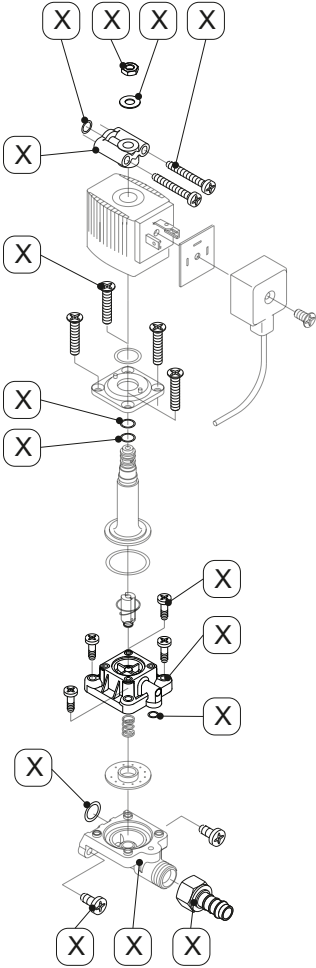
Illustration	Description / explanation & order reference
	<p>Valve unit, complete 4027849 [BM13V] 4027850 [BM13VCO]</p>
	<p>Valve attachment components 2000071 [BM13V] 2000072 [BM13VCO]</p>

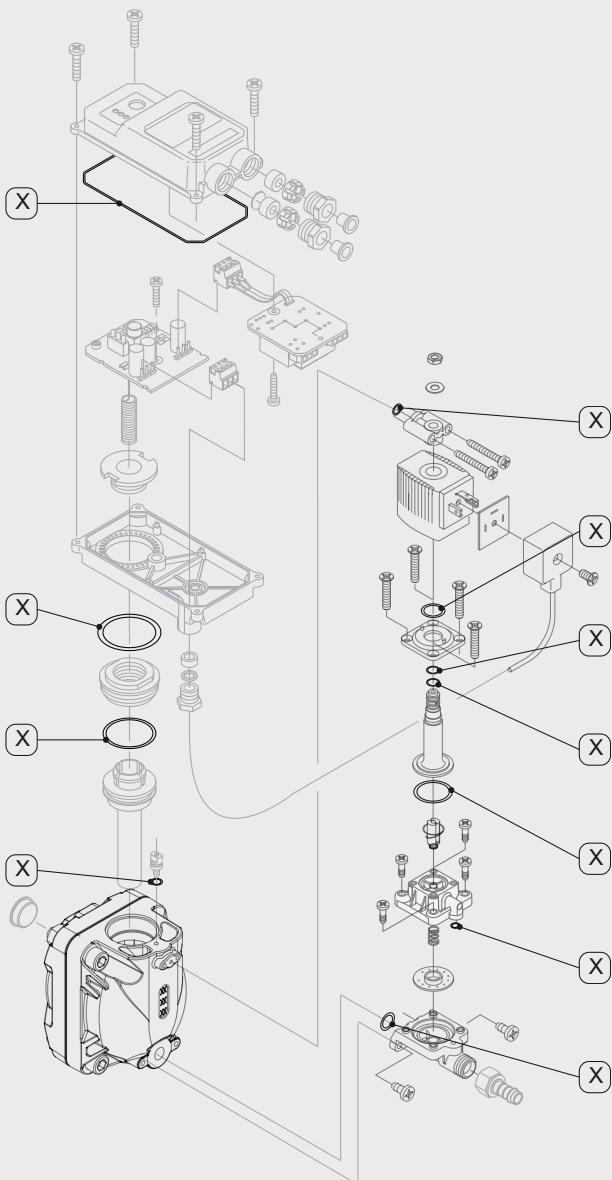
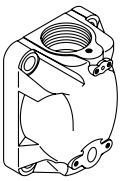
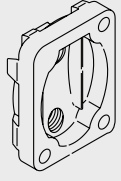
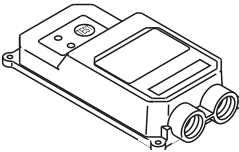
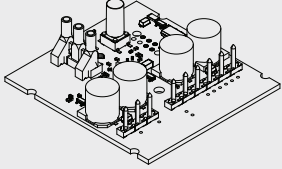
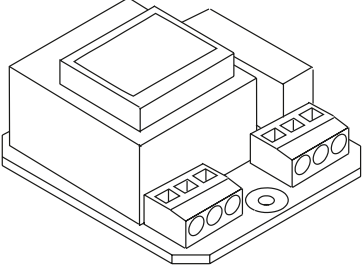
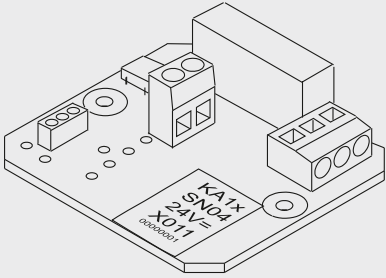



Illustration	Description / explanation & order reference
	<p>Set of seals 2000073</p>
	<p>Housing main part 2000075 [BM13V] 2000076 [BM13COV]</p>
	<p>Housing lid 2000077 [BM13V] 2000078 [BM13COV]</p>

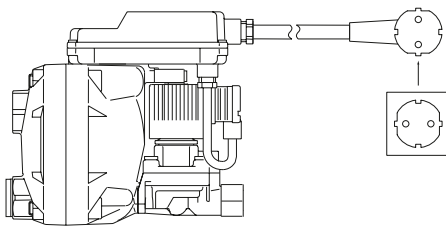

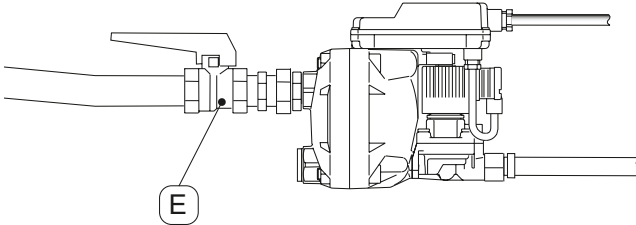
Illustration	Description / explanation & order reference
	<p>Top cover 2000066</p>
	<p>Control PCB 4047967</p>
	<p>Power control board 230 VAC 2000063</p>
	<p>Power control board 200 VAC 2000349</p>
	<p>Power control board 115 VAC 2000064</p>
	<p>Power control board 100 VAC 2000611</p>
	<p>Power control board 24 VAC 2000065</p>
	<p>Power control board 24 VDC 2000756</p>

12. Decommissioning

12.1 Warning notices


DANGER	Pressurised system!
	<p>Death or serious personal injury can result through contact with fast or suddenly escaping compressed gas or through bursting system parts.</p> <ul style="list-style-type: none"> • All work on the compressed gas system must be carried out in the depressurised state and with the compressed gas system secured against unintentional pressure build-up. • Set up a safety area around the working area during all assembly, installation, maintenance and repair work. • Before building up pressure in the pipework, check all pipe connections and tighten if necessary. • Slowly pressurise the system with pressure. • Avoid pressure blows and high differential pressures. • Assemble all pipelines without stress. • Install pipes tightly as feed and drain lines.
DANGER	Electric voltage!
	<p>There is a danger of death or serious injuries as well as malfunction and device failure following contact with components which are in contact with electric voltage.</p> <ul style="list-style-type: none"> • Only carry out installation, maintenance and repair work on the product and accessories when they have been disconnected and secured against being switched back on again. • Set up a safety area around the working area during all installation, maintenance and repair work. • For installation of the device, adhere to all applicable regulations (e.g. VDE 0100 / IEC 60364/ ATEX). • Connect the protective conductor (earth connection) according to regulations.
WARNING	Insufficient qualification!
	<p>Insufficient qualification of the personnel carrying out work on the product and accessories can lead to accidents, personal injury and damage to property as well as impair operation.</p> <ul style="list-style-type: none"> • All work on the product and accessories may only be carried out by skilled technical personnel - compressed gas technology.

12.2 Decommissioning work

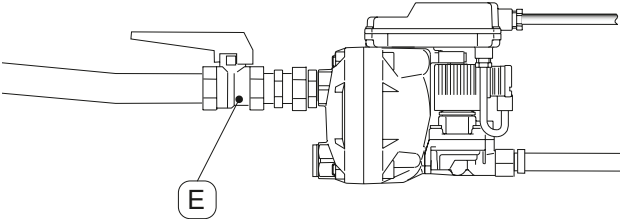
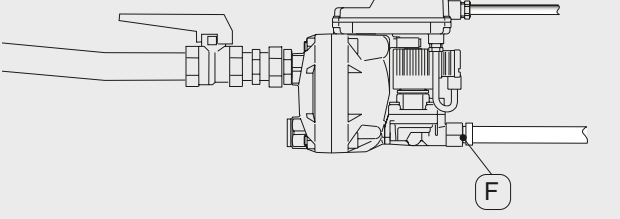
Illustration	Description / explanation
	<p>1. Disconnect the BEKOMAT® from the voltage supply and disconnect the potential-free contact completely.</p> <p> Without voltage supply being applied, an error message / fault is outputted via the potential-free contact and the external TEST button is without function.</p>
	<p>2. Close the feed line [E].</p>

13. Disassembly

For dismantling work to be carried out, the following prerequisites must be fulfilled and the preparatory tasks must have been completed.



Prerequisites		
Tools	Material	Protective equipment
<ul style="list-style-type: none"> e.g. adjustable spanner 		Always to be worn: 

Preparatory tasks	
1.	Depressurise the compressed gas system or the respective system section and secure it against unintentional pressure build-up.
2.	Decommissioning has been completed.

Illustration	Description / explanation
	3. Close and disassemble the feed line [E] .
	4. Disassemble the discharge drain [F] .

14. Disposal

14.1 Warning notices

NOTE	Inappropriate disposal!
	<p>Inappropriate disposal of parts and components, operating and auxiliary materials as well as cleaning media can cause environmental damage.</p>
	<ul style="list-style-type: none"> • Dispose of all components and parts, operating and auxiliary materials as well as cleaning media professionally and in accordance with regional legal provisions, regulations and requirements. • In case of uncertainties regarding disposal, always consult a regional waste management company.
INFORMATION	Disposal of electrical and electronic equipment
	<p>Electrical and electronic equipment (EEE) contains materials, components and substances which can be dangerous and harmful for human health and the environment if the waste from electrical and electronic equipment (WEEE) is not disposed of properly.</p>
	<p>Electrical and electronic equipment are marked by the crossed out rubbish bin. The crossed out rubbish bin symbolises that electrical and electronic equipment must be collected separately and must not be disposed of together with unsorted domestic waste.</p>
	<p>For this purpose, all communities have set up collecting systems where waste from electrical or electronic equipment can be handed in free of charge to recycling stations or other collecting points or can be collected directly from households. Contact the technical office of your local authority for further information.</p>
	<p>Users of electrical and electronic appliances must not dispose of electrical and electronic appliances together with domestic waste. Users must use the communal collecting systems to reduce the environmental impact of the disposal of electrical and electronic appliances and improve the possibilities for recycling recycling and reusing used electrical and electronic appliances.</p>

14.2 Disposal work

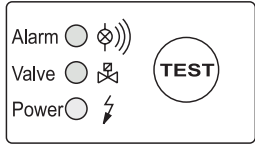
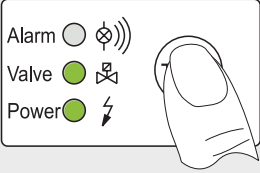
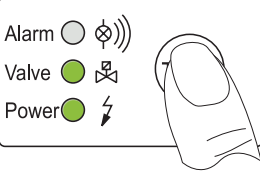
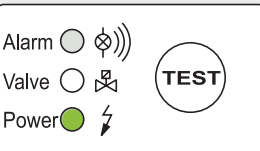
At the end of its useful life, dispose of the product properly e.g. through a specialist company. Do not dispose of electrical and electronic components via municipal waste disposal companies or household waste. Materials such as e.g. glass, plastic are recyclable to a major extent and can be used again.

Fulfil the following prerequisites before disposal:

Prerequisites	
1.	The BEKOMAT® has been decommissioned and disassembled.
2.	The BEKOMAT® has been cleaned and freed of any condensate residue.







Operating material	EU waste code
Adsorption and filter materials, cleaning wipes and protective clothing - contaminated by oils or other hazardous substances	15 02 02
Adsorption and filter materials, cleaning wipes and protective clothing - with the exception of those classified by 15 02 02	15 02 03
Packaging - paper and cardboard	15 01 01
Packaging - plastic material	15 01 02
Electric and electronic devices with the exception of those covered by 20 01 21, 20 01 23 and 20 01 35	20 01 36

15. Troubleshooting / FAQ

Illustration	Description / explanation	Troubleshooting
	All LEDs off	<ul style="list-style-type: none"> • Read the operating voltage off on the type plate and check it • Check whether voltage is applied to the terminals of the power control board (PE, L, N) • Check the plug-type connection of the connection terminal on the control PCB
	TEST button has been pressed but no condensate is being drained	<ul style="list-style-type: none"> • Check feed and discharge lines • Replace wear parts • Check whether the valve clocking can be heard, to do this press the TEST button several times • Check the plug-type connection of the connection terminal on the control PCB
	Condensate is only drained when the TEST button is pressed	<ul style="list-style-type: none"> • Install feed line at a gradient >3% • Mount venting line • Clean sensor tube • Check whether the necessary minimum pressure has been reached, if not: → install BEKOMAT® vacuum discharge
	Device constantly blows off air	<ul style="list-style-type: none"> • Clean entire valve unit • Replace wear parts • Clean sensor tube

16. Appendices

16.1 Approval certificates and declarations of conformity

Symbol	Description / explanation
	<p>CE marking</p> <p>The CE marking indicates that a product fulfils all the EU directives applicable for this product and that basic safety and health requirements were met during manufacturing of the product.</p> <p>The product may be sold on the European market.</p>
	<p>FCC marking</p> <p>The FCC marking indicates that a product fulfils the requirements of the Federal Communications Commission (FCC) and that basic safety and health requirements were met during manufacturing of the product.</p> <p>The product may be sold on the US American market.</p>
	<p>cTÜVus marking</p> <p>The cTÜVus marking indicates that a product fulfils the requirements of TÜV Rhineland for the Canadian and US American market and that basic safety and health requirements were met during manufacturing of the product.</p> <p>The product may be sold on the Canadian and US American market.</p>
	<p>EAC marking</p> <p>The EAC marking indicates that a product fulfils all the Eurasian directives applicable for this product and that basic safety and health requirements were met during manufacturing of the product.</p> <p>The product may be sold on the Eurasian market.</p>
	<p>WEEE marking</p> <p>The crossed out rubbish bin marks an electrical or electronic product that must not be disposed of with domestic waste at the end of its service life. Free collecting points for used electrical equipment as well as further acceptance points for reuse of the products are available for them to be returned. Addresses can be obtained from the local authorities.</p>
	<p>UKCA marking</p> <p>UK Conformity Assessed (UKCA) marking is a conformity mark that indicates conformity with the applicable requirements for products sold within Great Britain.</p>

BEKO TECHNOLOGIES GMBH
Im Taubental 7
41468 Neuss

GERMANY

Tel: +49 2131 988-0
www.beko-technologies.com



EU-Konformitätserklärung

Wir erklären hiermit, dass das nachfolgend bezeichnete Produkt den Anforderungen der einschlägigen Richtlinien und technischen Normen entspricht. Diese Erklärung bezieht sich nur auf das Produkt in dem Zustand, in dem das Produkt von uns in Verkehr gebracht wurde. Nicht vom Hersteller angebrachte Teile und/oder nachträglich vorgenommene Eingriffe bleiben unberücksichtigt.

Produktbezeichnung:	Kondensatableiter
Modelle:	BEKOMAT® 12 ..., 13 ..., 14 ..., 16 ...
Spannungsvarianten:	24 VDC, 24 VAC, 48 VAC, 100 VAC, 115 VAC, 200 VAC, 230 VAC
Max. Betriebsdruck:	16 bar(ü) (BEKOMAT® 12 ..., 13 ..., 14 ..., 16 ...) 25 bar(ü) (BEKOMAT® 13 ... PN25, 14 ... PN25) 40 bar(ü) (BEKOMAT® 13 ... PN40) 50 bar(ü) (BEKOMAT® 13 ... PN50) 63 bar(ü) (BEKOMAT® 12 ... PN63) 17,2 bar(ü) (BEKOMAT® 12, 13, 14 ... CRN)
Produktbeschreibung und Funktion:	Kondensatableiter zur elektronisch niveaugeregelten Ableitung von Kondensat im Druckluftnetz.

Niederspannungs-Richtlinie 2014/35/EU

Angewandte harmonisierte Normen: EN 61010-1:2010/A1:2019/AC:2019-04
Die Geräte mit einer Betriebsspannung von 24 ... 48 VAC und 18 ... 72 VDC fallen nicht in den Anwendungsbereich der Niederspannungs-Richtlinie.

EMV-Richtlinie 2014/30/EU

Angewandte harmonisierte Normen: EN 61326-1:2013

Druckgeräte-Richtlinie 2014/68/EU (BEKOMAT® 16)

Angewandtes Konformitätsbewertungsverfahren: Modul A
Kategorie: I
Beschreibung der Druckgeräte: Behälter für Fluide der Gruppe 2

ROHS II-Richtlinie 2011/65/EU

Die Vorschriften der Richtlinie 2011/65/EU zur Beschränkung der Verwendung bestimmter gefährlicher Stoffe in Elektro- und Elektronikgeräten werden erfüllt.

Der Hersteller trägt die alleinige Verantwortung für die Ausstellung dieser Konformitätserklärung.

Untersignet für und im Namen von:

Neuss, 21.02.2022

BEKO TECHNOLOGIES GMBH

i.V. Christian Riedel
Leiter Qualitätsmanagement International

BEKO TECHNOLOGIES GMBH
Im Taubental 7
41468 Neuss

GERMANY

Phone: +49 2131 988-0
www.beko-technologies.com



EU Declaration of Conformity

We hereby declare that the product named below complies with the stipulations of the relevant directives and technical standards. This declaration only refers to the product in the condition in which it has been placed into circulation by us. Parts which have not been installed by the manufacturer and/or modifications which have been implemented subsequently remain unconsidered.

Product designation:	Condensate drain
Models:	BEKOMAT® 12 ..., 13 ..., 14 ..., 16 ...
Supply voltage versions:	24 VDC, 24 VAC, 48 VAC, 100 VAC, 115 VAC, 200 VAC, 230 VAC
Max. operating pressure:	16 bar(g) (BEKOMAT® 12 ..., 13 ..., 14 ..., 16 ...) 25 bar(g) (BEKOMAT® 13 ... PN25, 14 ... PN25) 40 bar(g) (BEKOMAT® 13 ... PN40) 50 bar(g) (BEKOMAT® 13 ... PN50) 63 bar(g) (BEKOMAT® 12 ... PN63) 17.2 bar(g) (BEKOMAT® 12, 13, 14 ... CRN)
Product description and function:	Condensate drain for electronically level-controlled discharge of condensate in the compressed-air system.

Low Voltage Directive 2014/35/EU

Applied harmonised standards: EN 61010-1:2010/A1:2019/AC:2019-04
The devices with a working voltage of 24 ... 48 VAC and 18 ... 72 VDC are not governed by the scope of the Low Voltage Directive.

EMC Directive 2014/30/EU

Applied harmonised standards: EN 61326-1:2013

Pressure Equipment Directive 2014/68/EU

Applied conformity assessment procedure: Module A
Category: I
Description of the pressure equipment: Container device for fluids of Group 2

RoHS II Directive 2011/65/EU

The products meet the requirements laid down in European Directive 2011/65/EU concerning the restriction on the use of certain hazardous substances in electrical and electronic devices.

The manufacturer shall have sole responsibility for issuing this declaration of conformity.

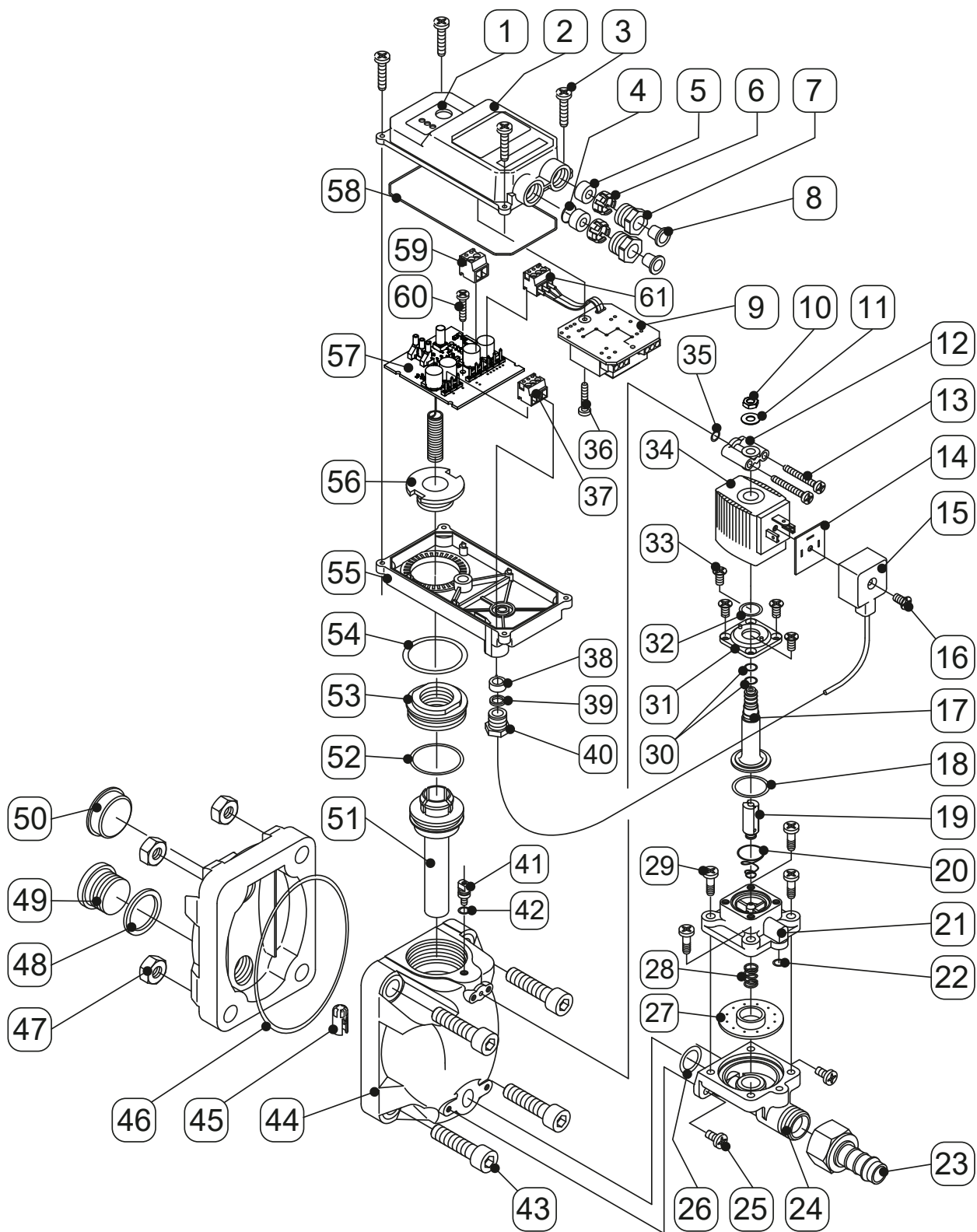
Signed for and on behalf of:

Neuss, 21 February 2022

BEKO TECHNOLOGIES GMBH

i.V. Christian Riedel
Head of International Quality Management

16.2 Exploded drawing



Pos. no.	Description / explanation
[1]	Operating label with TEST button
[2]	Top cover
[3]	Pan-head screw M3 x 10
[4]	Dust protection pane
[5]	Sealing ring for PG9
[6]	Clamp cage for PG9
[7]	Pressure screw for PG9
[8]	Locking element
[9]	Power control board
[10]	Hexagon nut M5
[11]	Washer
[12]	Control air cover
[13]	Pan-head screw M4 x 30
[14]	Seal for solenoid valve connector
[15]	Solenoid valve connector
[16]	Fixing screw for solenoid valve connector
[17]	Core guide pipe
[18]	Oval ring 21.8 x 1.5 x 2.5 mm
[19]	Valve core
[20]	Conical spring
[21]	Membrane cap
[22]	O-ring 5.5 x 1.5 mm
[23]	Hose connection Ø10 mm
[24]	Membrane seat
[25]	Pan-head screw M5 x 12
[26]	O-ring 16 x 2
[27]	Membrane
[28]	Pressure spring for membrane
[29]	Pan-head screw M5 x 20
[30]	O-ring 5 x 1.5 mm (top) O-ring 6 x 1.5 mm (bottom)
[31]	Flange

Pos. no.	Description / explanation
[32]	O-ring 11.1 x 1.78 mm
[33]	Countersunk head screw M4 x 10
[34]	Solenoid coil
[35]	O-ring 5.5 x 1.5 mm
[36]	Pan-head screw M3 x 6
[37]	Cable terminal for solenoid valve
[38]	Sealing ring for PG7
[39]	Pressure ring for PG7
[40]	Pressure screw for PG7
[41]	Earthing screw
[42]	O-ring 4 x 1.5 mm
[43]	Cylinder head screw M10 x 45
[44]	Housing main part
[45]	Sieve
[46]	O-ring 93 x 3 mm
[47]	Hexagon nut M10
[48]	Flat gasket 21.5 x 26 mm
[49]	Locking screw G1/2
[50]	Dust cap R 1/2
[51]	Sensor tube
[52]	O-ring 31.42 x 2.62 mm
[53]	Fixing screw
[54]	O-ring 34.59 x 2.62 mm
[55]	Bottom cover
[56]	Cover mounting element
[57]	Control PCB
[58]	Cord packing 2 x 315 mm
[59]	Cable terminal for external test button
[60]	Pan-head screw M3 x 6
[61]	Cable terminal for voltage supply

BEKO TECHNOLOGIES GmbH

Im Taubental 7
D - 41468 Neuss
Tel. +49 2131 988 0
Fax +49 2131 988 900
info@beko-technologies.com
service-eu@beko-technologies.com

DE**BEKO TECHNOLOGIES LTD.**

Unit 11-12 Moons Park
Burnt Meadow Road
North Moons Moat
Redditch, Worcs, B98 9PA
Tel. +44 1527 575 778
info@beko-technologies.co.uk

GB**BEKO TECHNOLOGIES S.à.r.l.**

Zone Industrielle
1 Rue des Frères Rémy
F - 57200 Sarreguemines
Tél. +33 387 283 800
info@beko-technologies.fr
service@beko-technologies.fr

FR**BEKO TECHNOLOGIES B.V.**

Veenen 12
NL - 4703 RB Roosendaal
Tel. +31 165 320 300
benelux@beko-technologies.com
service-bnl@beko-technologies.com

NL**BEKO TECHNOLOGIES
(Shanghai) Co. Ltd.**

Rm.715 Building C, VANTONE Center
No.333 Suhong Rd.Minhang District
201106 Shanghai
Tel. +86 (21) 50815885
info.cn@beko-technologies.cn
service1@beko.cn

CN**BEKO TECHNOLOGIES s.r.o.**

Na Pankráci 26/322
CZ - 140 00 Praha 4
Tel. +420 24 14 14 717 /
+420 24 14 09 333
info@beko-technologies.cz

CZ**BEKO Tecnológica España S.L.**

Torruella i Urpina 37-42, nave 6
E - 08758 Cervelló
Tel. +34 93 632 76 68
Mobil +34 610 780 639
info.es@beko-technologies.es

ES**BEKO TECHNOLOGIES LIMITED**

Room 2608B, Skyline Tower,
No. 39 Wang Kwong Road
Kwloon Bay Kwloon, Hong Kong
Tel. +852 2321 0192
Raymond.Low@beko-technologies.com

HK**BEKO TECHNOLOGIES INDIA Pvt. Ltd.**

Plot No.43/1 CIEEP Gandhi Nagar
Balanagar Hyderabad
IN - 500 037
Tel. +91 40 23080275 /
+91 40 23081107
Madhusudan.Masur@bekoindia.com
service@bekoindia.com

IN**BEKO TECHNOLOGIES S.r.l. a socio unico**

Via Druento 82
I - 10078 Venaria Reale (TO)
Tel. +39 011 4500 576
Fax +39 0114 500 578
info.it@beko-technologies.com
service.it@beko-technologies.com

IT**BEKO TECHNOLOGIES K.K**

KEIHIN THINK Building 8 Floor
1-1 Minamiwatarida-machi
Kawasaki-ku, Kawasaki-shi
JP - 210-0855
Tel. +81 44 328 76 01
info@beko-technologies.jp

JP**BEKO TECHNOLOGIES Sp. z o.o.**

ul. Pańska 73
PL - 00-834 Warszawa
Tel. +48 22 314 75 40
info.pl@beko-technologies.pl

PL**BEKO TECHNOLOGIES S. de R.L. de C.**

BEKO Technologies, S de R.L. de C.V.
Blvd. Vito Alessio Robles 4602 Bodega 10
Zona Industrial
Saltillo, Coahuila, 25107
Mexico
Tel. +52(844) 218-1979
informacion@beko-technologies.com

MX**BEKO TECHNOLOGIES, CORP.**

900 Great Southwest Pkwy SW
Atlanta, GA 30336
USA
Tel. +1 404 924-6900
beko@bekousa.com

US