

Original installation and operating manual

BEKOMAT® 31U Built-in

> BM31UBI

■ Table of contents

1. Information on documentation	4
1.1 Contact	4
1.2 Installation information and operating manual.....	4
2. Safety	5
2.1 Use	5
2.1.1 Intended use.....	5
2.1.2 Foreseeable misuse	6
2.2 Responsibility of the operator	6
2.3 Target group and personnel.....	7
2.4 Explanation of the symbols used	8
2.5 Safety instructions and warning notices.....	9
2.5.1 Basic safety instructions.....	9
2.5.2 Safe operation.....	9
2.5.3 Sudden escape of pressurized fluids	10
2.5.4 Electrical voltage	10
2.5.5 Transport and storage.....	11
2.5.6 Installation.....	11
2.5.7 Maintenance	12
2.5.8 Malfunctions and property damage	12
2.5.9 Handling hazardous substances.....	12
2.5.10 Work on electronic components.....	13
2.5.11 Use of spare parts, accessories or materials	13
2.6 Warning notices	13
3. Product information	14
3.1 Product overview	14
3.2 Exploded view	15
3.3 How it works.....	16
3.4 Type plate	17
3.5 Scope of delivery	18
4. Technical data	19
4.1 Operating parameters	19
4.2 Storage and transport parameters	20
4.3 Materials.....	20
4.4 Screw tightening torques.....	20
4.5 Dimensions.....	21
4.6 Installation dimensions.....	22
4.7 Terminal diagram	22
5. Transport and storage	23
5.1 Transport	23
5.2 Storage.....	23
6. Installation	24
6.1 Warning notices	24
6.2 Installation conditions	25

6.3 Installation work	27
7. Electrical installation	29
7.1 Connection work	30
7.1.1 Power supply connection.....	30
8. Commissioning.....	33
8.1 Warning notices	33
8.2 Commissioning work.....	34
9. Operation	35
9.1 Warning notices	35
9.2 Operating conditions	36
10. Maintenance	37
10.1 Warning notices	37
10.2 Maintenance plan	38
10.3 Maintenance work	38
10.3.1 Service-Unit change	39
10.3.2 Function test.....	43
10.3.3 Visual inspection.....	43
10.3.4 Leak test.....	43
10.3.5 Cleaning.....	44
11. Consumables, accessories and spare parts.....	45
11.1 Order information.....	45
11.2 Accessories.....	45
11.3 Spare parts.....	45
12. Decommissioning	46
12.1 Warning notices	46
12.2 Decommissioning work	47
13. Disassembly	48
13.1 Warning notices	48
13.2 Disassembly work	48
14. Disposal	50
14.1 Warning notices	50
14.2 Disposal of operating fluids and auxiliary materials	51
14.3 Disposal of components	51
15. Troubleshooting.....	52
16. Appendices.....	53
16.1 Certificates and declarations of conformity	53
17. Notes	54

1. Information on documentation

This documentation describes all steps necessary for the use and operation of the product and the accessories.

1.1 Contact

Manufacturer	Service and tools
BEKO TECHNOLOGIES CORP. 900 Great Southwest Pkwy SW US - Atlanta, GA 30336 Phone: +1 (404) 924-6900 Fax: +1 (404) 629-6666 beko@bekousa.com	BEKO TECHNOLOGIES CORP. 900 Great Southwest Pkwy SW US - Atlanta, GA 30336 Phone: +1 (404) 924-6900 Fax: +1 (404) 629-6666 beko@bekousa.com

INFORMATION	Country specific manufacturer representation
	The contact to the country-specific manufacturer's representative can be found in the address section on the back or can be established via the contact form on the manufacturer's website.

1.2 Installation information and operating manual

INFORMATION	Copyright protection
	The content of this installation and operating manual, in the form of text, images, photos, drawings, diagrams, and other illustrations, is copyright protected by the manufacturer. Unless expressly permitted, the dissemination and reproduction of this document, as well as the exploitation and disclosure of its contents, are strictly prohibited.

Publication date	Revision	Version	Reason for change	Scope of change
1 August 2022	03	00	Editorial revision	Editorial changes
October 1, 2023	04	00	Editorial revision	Maintenance note

The installation and operating manual, referred to as the manual in the following, must be kept near the product at all times and must always be in a legible condition.

The manual must be included if the product is sold or handed over to another party.

NOTICE	Observe the manual!
	This manual contains all basic information required to safely operate the product, and operators must read the manual before carrying out all work. Failure to follow the manual may cause risk to people and materials and may result in malfunctions and disruption to operations.

2. Safety

2.1 Use

The **BEKOMAT® 31U Built-in**, hereafter also referred to as the product or **BEKOMAT®**, is an electronically level-controlled condensate drain and is used to discharge condensate in pressurized systems. The **BEKOMAT®** discharges condensate under operating pressure without any pressure loss.

2.1.1 Intended use

Any other use besides that described in this manual is deemed improper and poses a risk to personnel and the environment.

The following must be observed for proper use:

- Read and observe this manual.
- Use the product and accessories indoors only.
- Only use the product and accessories within the operating parameters indicated in the technical data.
- Only use the product and accessories within the operating parameters specified in the “Technical data” section of this manual and in accordance with the terms of supply.
- Only use the product and the accessories with fluids free of caustic, aggressive, corrosive, toxic, flammable, oxidizing, and inorganic components. In case of doubt, analyze the media or accessories.
- Only use the product and accessories in an environment where at a maximum, only splash water may occur. The splash water must be free of corrosive components.
- Only use the product and accessories in areas that are free from toxic and corrosive chemicals and gases.
- Only use the product and accessories within a pipeline system designed for the operating parameters specified in section “4. Technical data” on page 19, with appropriate connections, pipe diameters and installation clearances.
- Only use the product and accessories outside of explosion hazard areas.
- Only use the product and accessories away from direct sunlight and heat sources, and outside of areas that may frost.
- Only combine the product and the accessories with the recommended products and components from the manufacturer indicated in this manual.
- Comply with the specified maintenance plan.

Before using the product and accessories, the operator must ensure that all conditions and requirements for ensuring proper use are available.

The product and accessories are designed only for stationary use in commercial or industrial areas. All of the assembly, installation, operation, maintenance, disassembly and disposal work described must be performed exclusively by qualified skilled technical personnel.

2.1.2 Foreseeable misuse

If the product or accessories are used in a manner other than as described in the “Intended use” section, this will be considered a case of foreseeable misuse. Foreseeable misuse includes using the product or accessories in a manner that is not intended by the manufacturer or suppliers but that may occur due to foreseeable human behavior.

Foreseeable misuse includes:

- Carrying out modifications of all kinds, especially constructive and process-related alterations.
- Disabling or failing to use available or recommended safety equipment.
- The use of the product and accessories in systems with carbon dioxide as the operating medium.

This list does not claim to be exhaustive, since it is not possible to indicate all possible misuses in advance. If the operator knows of misuses of the product or accessories that are not listed here, the manufacturer must be informed of these promptly.

2.2 Responsibility of the operator

The operator must ensure the following in order to avoid accidents, disruptions and environmental impacts:

- Before taking any action, check whether this manual belongs to the product.
- The product and accessories are used, maintained and serviced properly.
- The product and accessories are used only with recommended and functional safety equipment.
- All assembly work, installation work, and maintenance work is carried out exclusively by qualified skilled technical personnel.
- Personnel have the required personal protective equipment, and this equipment is used.
- Suitable technical safety measures are taken to ensure that the permissible operating parameters are observed.
- Keep all safety labels and the type plate on the product in legible condition. Replace damaged and illegible markings immediately.

2.3 Target group and personnel

This manual is intended for the personnel listed below who are involved in working on the product or its accessories.

INFORMATION	Personnel requirements
	<p>Personnel may not undertake any actions involving the product or accessories if they are under the influence of drugs, medications, alcohol or other substances that may impair their perception.</p>

Operating personnel

Operating personnel are persons who are able to safely operate the product and accessories through their knowledge of the manual and through instruction on the product and accessories. The operating personnel is able to recognize possible malfunctions and dangerous situations independently and to initiate appropriate measures.

Skilled technical personnel - Transport and storage

"Skilled technical personnel - Transport and storage" are personnel whose training, professional experience, and qualifications have provided them with all the skills necessary to safely complete any work associated with transportation, identify potential hazards independently, and take measures to prevent those hazards.

These skills include, in particular, experience handling hoists, forklifts, lifting equipment, and lifting devices, as well as familiarity with all regionally applicable regulations, standards and directives related to transportation and storage.

Skilled technical personnel specialized in pressure equipment and systems

"Skilled technical personnel specialized in pressure equipment and systems" refers to personnel whose training, professional experience, and qualifications have provided them with all the skills necessary to safely complete any work associated with pressurized fluids and systems, provide instructions, identify potential hazards independently, and take measures to prevent those hazards.

These skills include, above all, experience with the use of measuring equipment, control equipment, and regulation equipment, as well as familiarity with all regionally applicable regulations, standards, and directives for pressurized systems.

Skilled technical personnel - Trained electricians

"Skilled technical personnel - Trained electricians" refers to personnel whose basic and advanced training, professional experience, and qualifications have provided them with all the skills necessary to safely complete any work involving electricity, identify potential hazards independently, and take measures to prevent those hazards.









These skills include, in particular, experience handling electrical equipment, measuring equipment, control equipment, and regulation equipment, as well as familiarity with all regionally applicable regulations, standards, and directives (such as VDE 0100 / IEC 60364 / ATEX) for handling electrical equipment.

Skilled technical personnel - Service

"Skilled technical personnel - Service" are persons who have the skills and qualifications for all the aforementioned definitions concerning professional technicians. "Skilled technical personnel - Service" must be verifiably trained and authorized for all work on the product.

2.4 Explanation of the symbols used

The symbols used in the following indicate important and safety-related information that must be observed in handling the product and to ensure safe and optimal operation.

Symbol	Description / explanation
	General warning symbol (danger, warning, caution)
	Warning of pressurized system
	Warning of electrical voltage
	Observe the installation and operating manual
	General mandatory sign
	Wear safety shoes
	Wear protective gloves (cut-resistant and liquid-resistant)
	Wear safety glasses with side protection (goggles)
	General information

2.5 Safety instructions and warning notices

This section provides an overview of all important safety aspects for the protection of persons and for the safe and trouble-free operation of the product and accessories.

The following sections list the dangers that arise from this product and the accessories even when used as intended. To minimize the risk of personal injury and property damage and to avoid dangerous situations, observe the safety instructions listed and comply with the warning notices in the other sections of this manual.

Basic warnings and required qualifications of the technical personnel are listed at the beginning of each section in the section "Warning notices".

Action-specific warning notices are located directly before descriptions of potentially dangerous actions or action sequences.

2.5.1 Basic safety instructions

- Before starting work, consult the technical documents for the entire system and make sure to observe the general operating manual.
- Before starting work, carry out a last minute risk assessment.
- Use appropriate personal protective equipment for all work.
- A safe area must be set up around the work area during all installation, maintenance and repair work.
- Use existing system-specific lockout/tagout (LOTO) procedures in order to safely de-energize and isolate the system or system sections.

2.5.2 Safe operation

The following actions may result in serious injury or death:

- Starting up and operating the product and accessories outside the permissible limits and operating parameters
- Unauthorized tampering and unauthorized modifications to the product and accessories

To guarantee the safe operation of the product and accessories, observe the following:

- Observe the limits and operating parameters specified on the type plate and in the manual.
- Check whether operating parameters are changed or restricted through the use of permitted accessories.
- Observe the installation conditions and ambient conditions.
- Observe the maintenance intervals.

2.5.3 Sudden escape of pressurized fluids

The following situations may result in serious injury or death:

- Contact with fluids that escape quickly or abruptly
- Bursting system components
- Pressurized hose and pipe whipping as a result of disconnection

For the safe handling of pressurized systems, observe the following:

- Observe the following safety rules for all work:
 1. Shut down the system or system section.
 2. Secure the system or system section against restarting.
 3. Reduce the pressure in the system or all system sections to the ambient pressure.
 4. By slowly releasing the pressure in a controlled manner with relief valves, for example
- Lock out and tag out the system or system section so that it cannot be pressurized again.
- Check the system or system section for safety issues, contamination and possible damage.
- Before pressurization, check all system connections for leak tightness and retighten them if necessary.
- Make absolutely sure to charge the system or system section with pressure slowly.
- Avoid pressure surges and high pressure differentials.
- Compensate vibrations occurring in the pipeline network by using vibration dampers.

2.5.4 Electrical voltage

Contact with live components may result in serious personal injury or death.

To ensure the safe handling of live components, observe the following:

- Connect the product and accessories to a power supply only if they are in proper working order.
- Comply with all regionally applicable regulations and requirements during installation.
- The power supply must have a disconnect device that is easily accessible and close to the product.
 - This disconnect device must disconnect all live cables.
- Connect the equipment protective conductor (earthing) in accordance with applicable regulations.
- Only operate the product and accessories with a complete and closed cover, closed electronic housing, or closed control cabinet.
- Before starting work on the product:
 1. De-energize
 - Disconnect the product from all poles and all sides
 2. Lock out and tag out
 3. Check to make sure that the product is completely de-energized
 - With an appropriate and approved measuring device (e.g., two-pole voltage tester)
 4. Ground and short circuit

2.5.5 Transport and storage

Improper transport or storage can lead to personal injury or damage to property.

In order to ensure safety during the transport and storage of the product and accessories, observe the following:

- Use personal protective equipment for all work with packaging material.
- Handle the packaging of the product and the accessories with care.
- Transport and handle the product and accessories according to the labeling on the packaging.
- Only use transportation, hoisting and lashing equipment that is suitable and in proper working order.
- Only use transportation, hoisting and lashing equipment that is rated for the total weight of the product.
- Observe the permissible transport parameters and storage parameters.
- Do not store the product and accessories exposed to direct sunlight and heat sources.

2.5.6 Installation

The improper assembly or electrical installation of the product and accessories may result in personal injury and property damage and impair operation.

For safe assembly and electrical installation, observe the following:

- Mount the product, the accessories, all parts and materials used free of mechanical tension.
- Check all plug connections are correctly fitted.
- Avoid any risk of tripping by using appropriate cable guides and hose guides.
- Avoid mechanical stress on the cables.
- Fasten and fix all hoses in such a way that they cannot make any percussive movements.
- Securely pipe the inlet and drain lines.

2.5.7 Maintenance

Improper performance of maintenance and repair work can result in serious injury or death.

For safe maintenance and repairs, observe the following:

- Before starting work, bleed the pressurized product and accessories and lock them out so that they cannot be pressurized by accident.
- Before starting work, de-energize the product and the accessories and lock and tag them out.
- Only use materials approved for the respective application.
- Use only suitable tools in perfect condition.
- Only use cleaned pipes and hoses that are free of dirt and corrosion.
- Do not use abrasive or aggressive cleaning agents or solvents that could damage the external coating (e.g. labels, type plate, corrosion protection, etc.).
- Do not clean or operate the device with hard or pointed implements.
- Make sure to only use the specified materials and fluids for cleaning.
- Comply with all applicable hygiene regulations and regional and internal hygiene rules and standards.
- Ensure order and cleanliness during maintenance and repair work. Prevent impurities from penetrating into the opened product or accessories. Store dismantled components and accessories directly in a safe place.
- After completing maintenance and repair work, remove all tools and cleaning agents used, as well as all parts that are no longer needed, from the work area.
- Only dispose of the product and accessories once they have been cleaned and are free of any residual fluids.
- All components, assemblies, operating, auxiliary materials and cleaning agents must be disposed of appropriately and according to regional statutory specifications and provisions.
- Dispose of electrical and electronic components through a specialized disposal company or return them to the manufacturer.

2.5.8 Malfunctions and property damage

As well as causing personal injury, failure to observe safety instructions and warning notices may result in malfunctions, disruption to operations, and property damage.

2.5.9 Handling hazardous substances

Substances contained in the condensate that are hazardous to health and the environment can irritate and damage the skin, eyes and mucous membranes on contact. In addition, condensate contaminated with pollutants must not be allowed to enter the sewerage system, water bodies or the ground.

For the safe handling of polluted condensate, observe the following:

- Use suitable protective equipment when handling condensate.
- Collect and dispose of leaked or spilled condensate in accordance with the locally applicable legal requirements and regulations.

2.5.10 Work on electronic components

Electrostatic discharge (ESD) can cause damage to electronic components and result in malfunctions, disruption to operations, and damage to materials.

- Take proper measures to prevent electrostatic discharge (e.g., grounding, equipotential bonding, anti-static mats, etc.).

2.5.11 Use of spare parts, accessories or materials

The use of incorrect spare parts, accessories or materials, as well as auxiliary and operating materials, may pose a mortal danger or the danger of severe injuries. It may also result in malfunctions, disruption to operations, and damage to materials.

- Only use undamaged original parts, auxiliary and operating materials specified by the manufacturer in carrying out all work.
- Only use materials permitted for the specific purpose and suitable tools in proper condition.
- Only use cleaned pipelines free from dirt and corrosion.
- Only use electrical components and materials that comply with the regionally applicable legal requirements and regulations (standards, directives, etc.) for electrical safety.

2.6 Warning notices

Warning notices caution against dangers in handling the product and accessories.

Failure to observe warning notices may result in personal injury, damage to property, and impairment to operations.

Structural design:

SIGNAL WORD	Type and source of danger
 Symbol	Possible consequences if the hazard is not observed
	<ul style="list-style-type: none"> • Measures to avoid the hazard

Signal words:

DANGER	Imminent danger Consequences of non-compliance: Death or severe personal injury
WARNING	Imminent danger Consequences of non-compliance: Death or severe personal injury are possible
CAUTION	Potential danger Consequences of non-compliance: Personal injury or damage to property is possible
NOTICE	Additional information Consequences of non-compliance: Property damage and disadvantages in operation are possible. No danger to personnel or safe operation.

3. Product information

3.1 Product overview

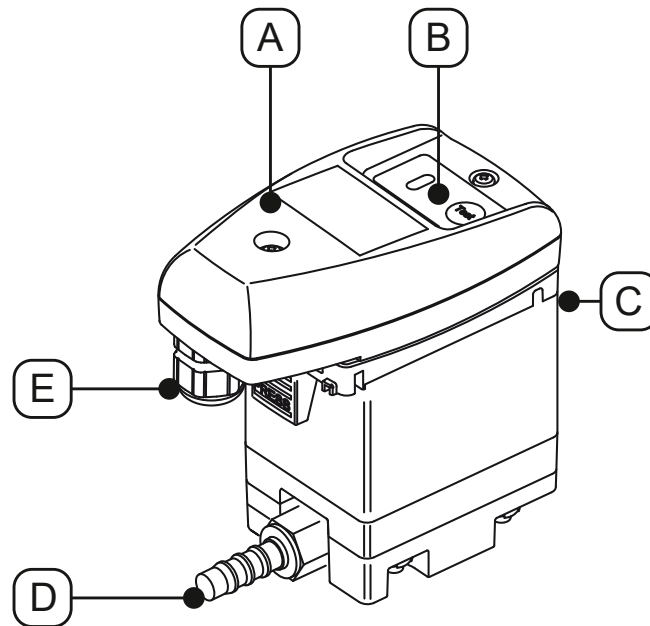

Pos. no.	Description / explanation	Pos. no.	Description / explanation
[A]	Control unit complete	[D]	Condensate drain
[B]	Control panel	[E]	Cable fitting
[C]	Condensate inlet		

3.2 Exploded view

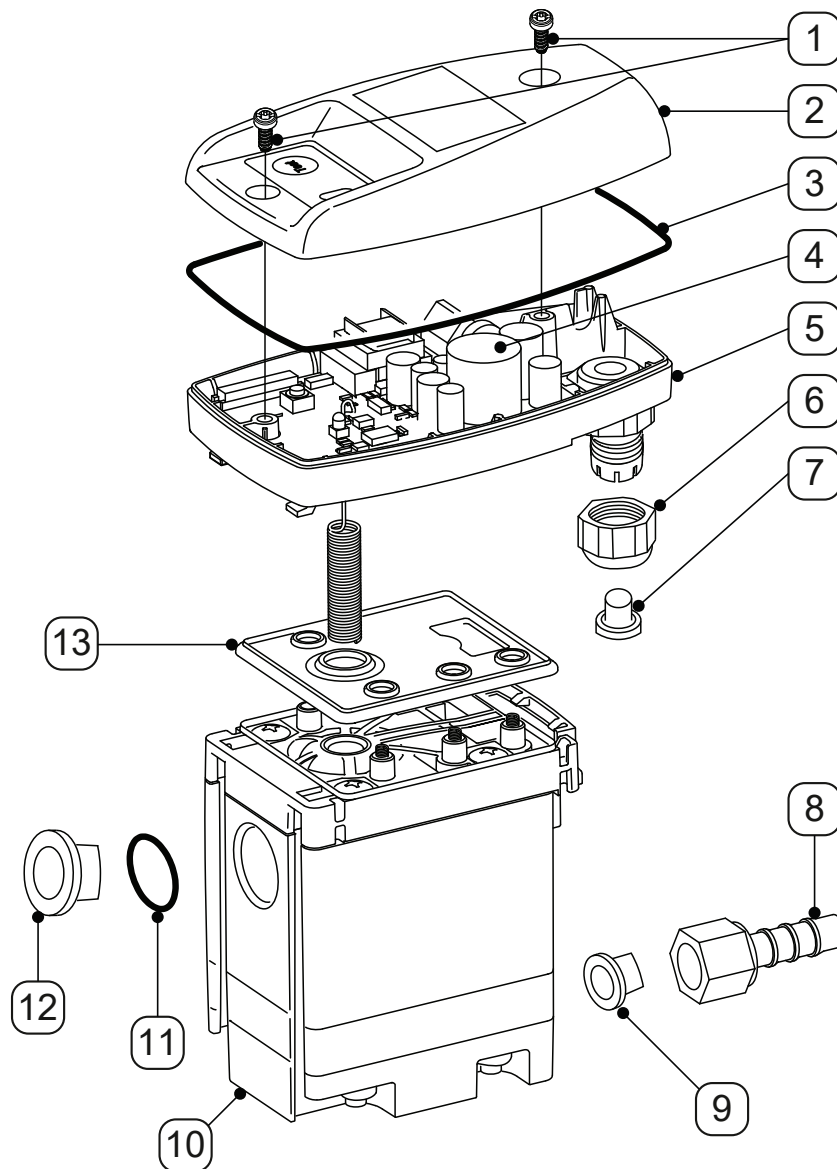

Pos. no.	Description / explanation	Pos. no.	Description / explanation
[1]	Screw, 3.5x 10 mm	[8]	Barbed hose fitting
[2]	Top cover	[9]	Tapered plug
[3]	Molded seal	[10]	Service-Unit
[4]	Sensor board	[11]	O-ring 20 x 2 mm
[5]	Bottom cover	[12]	G1/2" sealing plug
[6]	Screw connection	[13]	Sealing mat
[7]	Plug		

3.3 How it works

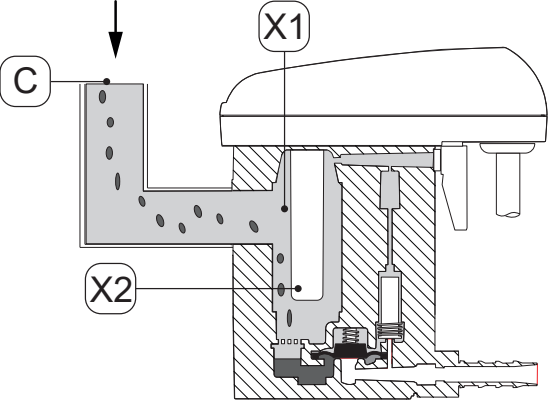
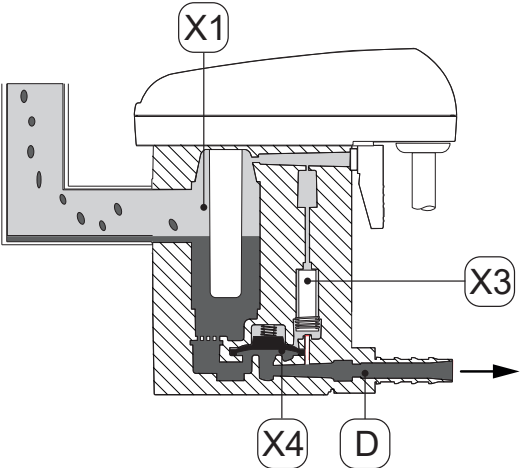
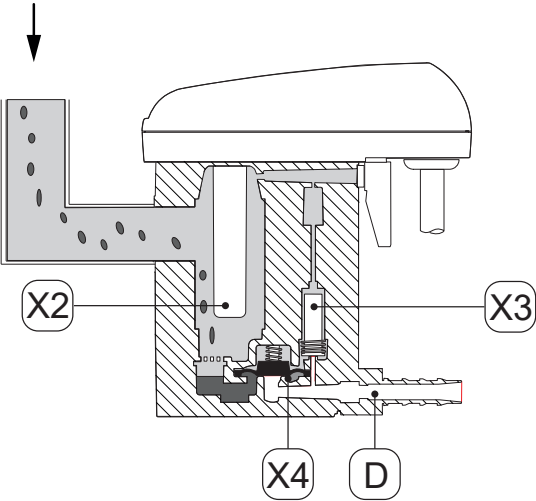
Image	Description / explanation
	<p>The condensate flows into the BEKOMAT® via the condensate inlet [C] and accumulates in the housing [X1]. The fill level in the housing [X1] is continuously monitored by a capacitive sensor in the sensor tube [X2].</p>
	<p>As soon as the condensate has reached the maximum fill level, the pilot valve [X3] is switched via the control system. The pilot valve [X3] switches and the area above the membrane [X4] is vented. The membrane [X4] lifts off the valve seat and the overpressure in the housing [X1] forces the condensate into the condensate drain [D].</p>
	<p>When the sensor in the sensor tube [X2] is no longer covered by condensate, the control switches the pilot valve [X3] and pressure builds up above the membrane [X4]. The membrane [X4] is pressed onto the valve seat and the condensate drain [D] is tightly closed. A switching cycle starts again with the supply of condensate.</p>

3.4 Type plate

The type plate, which contains identification information and operating parameters for the product, is located on the bottom cover.

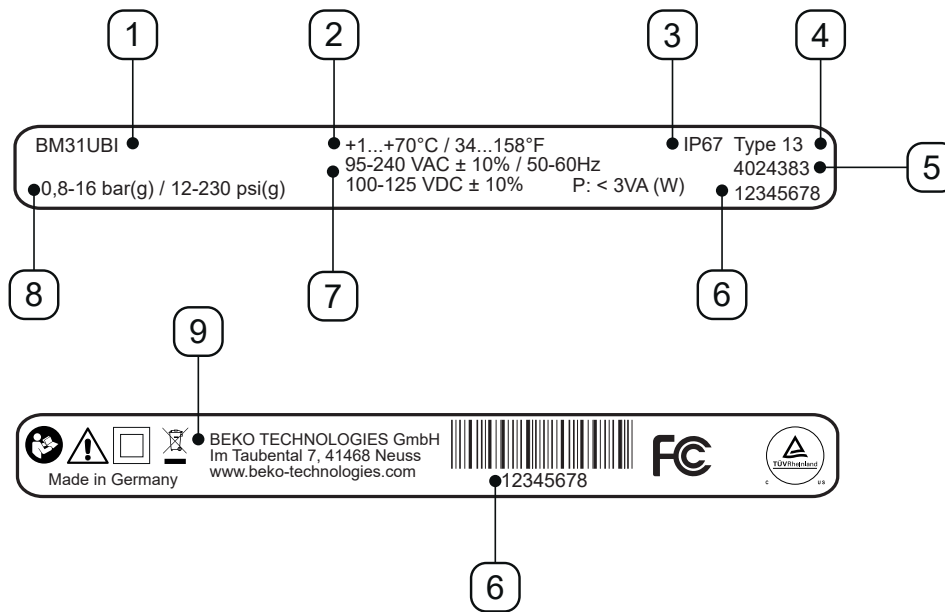



Example image

Pos. no.	Description / explanation
[1]	Product designation
[2]	Operating temperature
[3]	IP protection class
[4]	Enclosure rating
[5]	Material number
[6]	Serial number
[7]	Operating voltage
[8]	Operating pressure
[9]	Manufacturer

For more information, refer to section “2.4 Explanation of the symbols used” on page 8.

3.5 Scope of delivery

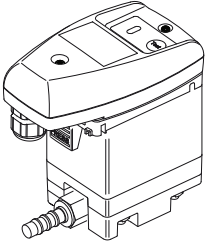
The following table shows the scope of delivery for the product:

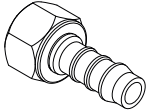
Image	Description / explanation
	BEKOMAT® 31U Built-in
	Original installation and operating manual
	1 x nozzle

4. Technical data

4.1 Operating parameters

BEKOMAT®	31U Built-in
Relative ambient humidity	10 ... 80 %, without condensate formation
Maximum operating height	2000 m 2187.23 yd
Min. / max. operating pressure	0.8 ... 16 bar(g) 12 ... 230 psi(g)
Min. / max. operating temperature	+1 ... 70 °C +34 ... +158 °F
Average discharge rate	0.63 l/h 0.17 gal/h
Maximum discharge rate (short-time)	5.5 l/h 1.45 gal/h
Condensate inlet port*	1 x G1/2", female, maximum screw-in depth: 13.5 mm (1/2 in)
Condensate drain port	1 x G1/4", male, barbed hose fitting for inside hose diameter of 8 ... 10 mm (0.31 ... 0.39 in)
Fluids	Condensate, oily or oil-free
Empty weight	0.6 kg 1.32 lbs
Operating voltage	95 ... 240 VAC ±10% (50 ... 60 Hz) / 100 ... 125 VDC ±10 % oder 24 ... 48 VAC ±10% (50 ... 60 Hz) / 18 ... 72 VDC ±10 % (see type plate)
Power consumption	0.6 ... 3 VA (W)
Degree of protection	IP67
Enclosure rating	Type 13
Overvoltage category (IEC 61010-1)	II
Degree of pollution (IEC 61010-1)	2
Recommended cable diameter	5 ... 10 mm 0.23 ... 0.33 in
Recommended wire cross-section	0.25 ... 1 mm ² AWG 18 ... 24
Recommended cutting of the cable sheath	~ 50 mm ~ 1.97 in
Recommended stripping length for cable wires	~ 6 mm ~ 0.24 in

* NPT thread version is available as an option.

4.2 Storage and transport parameters

BEKOMAT®	31U Built-in
Minimum / maximum temperature, storage and transport	+1 ... +70 °C +34 ... +158 °F

4.3 Materials

BEKOMAT®	31U Built-in
Housing	Aluminum and plastic, glass fiber reinforced
Membrane	FKM

4.4 Screw tightening torques

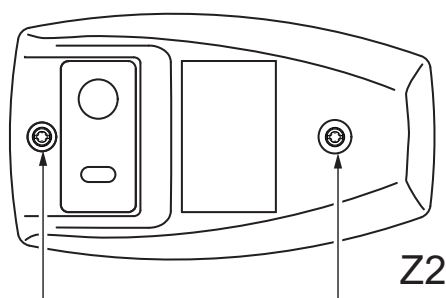
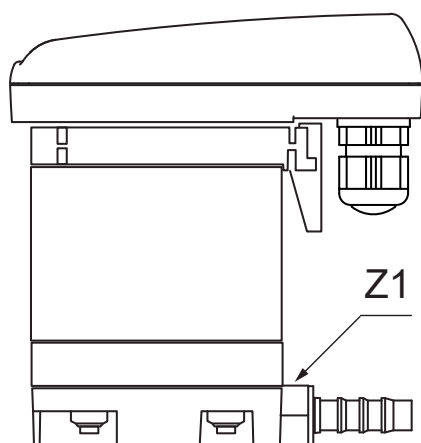

Pos. no.	Description / explanation	Tightening torques
[Z1]	Barbed hose fitting, condensate drain	3 ... 4 Nm (2.21 ... 2.95 ft-lb)
[Z2]	Screws, top cover	0.9 Nm +0.5 Nm (0.66 ft-lb +0.37 ft-lb)

4.5 Dimensions

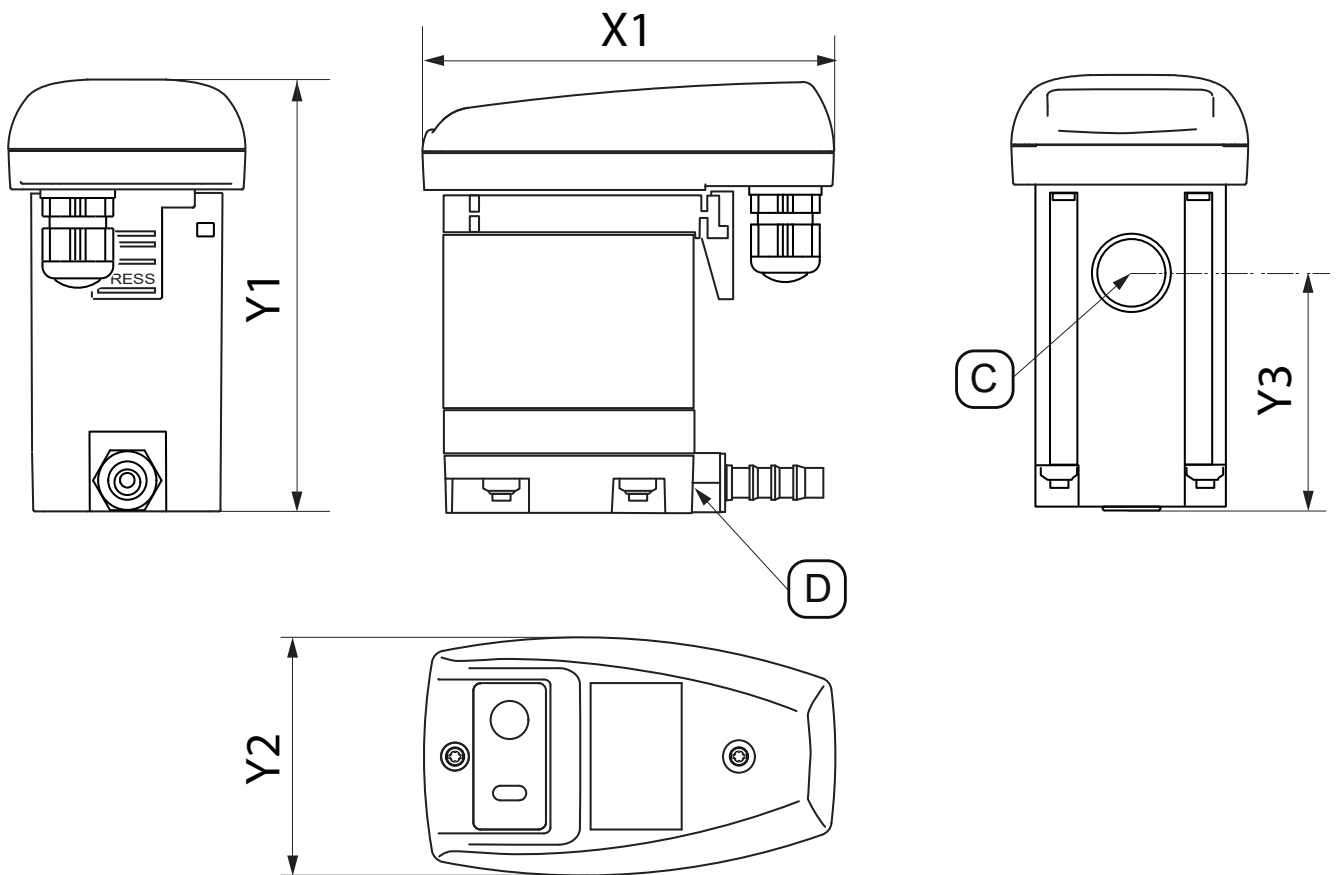

Splitting unit	BEKOMAT® 31U Built-in
[X1]	113 mm 4.45 in
[Y1]	118 mm 4.65 in
[Y2]	65 mm 2.56 in
[Y3]	62.5 mm 2.46 in
[C] - Condensate inlet port	G1/2" (NPT 1/2")
[D] - Condensate drain port	G1/4" Ø 8-10 (diameter of 0.32 - 0.39)



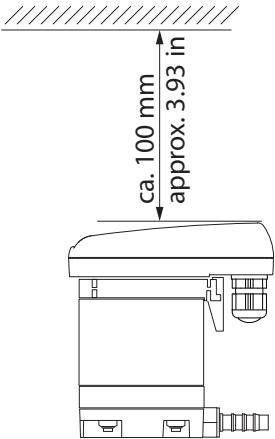

4.6 Installation dimensions

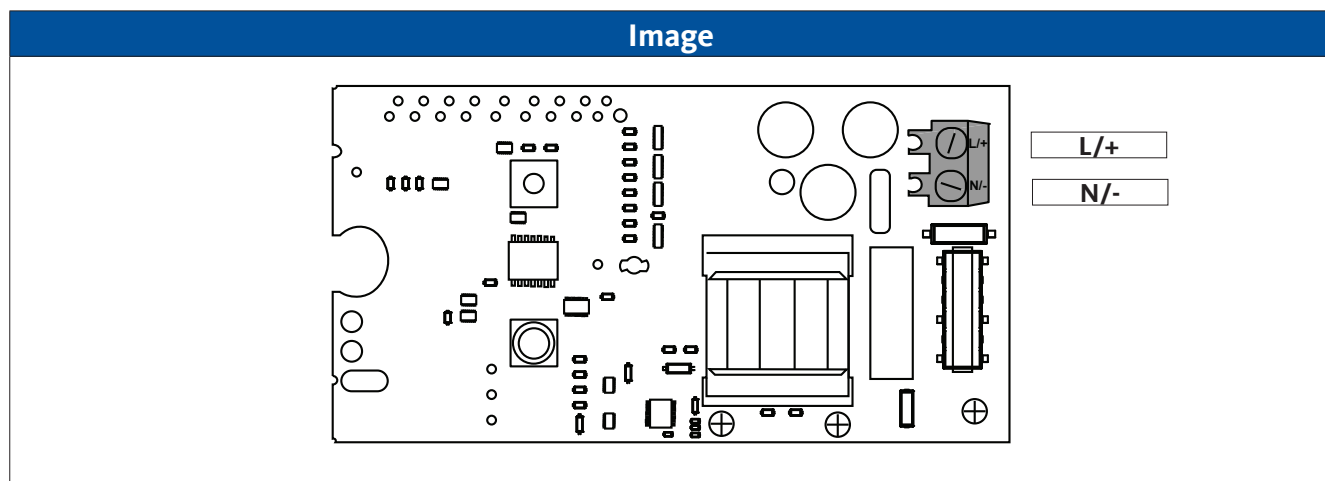
Image	Description / explanation
	<p>During installation, leave sufficient mounting space above the top cover so that the LEDs are visible and the TEST button can be actuated.</p>

4.7 Terminal diagram



5. Transport and storage

WARNING	Insufficient qualification
	<p>If personnel have insufficient qualifications, this may result in accidents, personal injury and property damage as well as operating disruptions while working on the product or its accessories.</p> <ul style="list-style-type: none"> • The work on the product and accessories described in the following may only be carried out by transportation and storage skilled technical personnel and must be documented.
CAUTION	Improper transportation or storage
 	<p>Improper transportation or storage may result in personal injury.</p> <ul style="list-style-type: none"> • Use personal protective equipment for all work with packaging material. • Handle the packaging of the product and the accessories with care. • Transport and handle the product and accessories according to the labeling on the packaging. • Only use transportation, hoisting and lashing equipment that is suitable and in proper working order. • Only use transportation, hoisting and lashing equipment that is rated for the total weight of the product. • Observe the permissible transport parameters and storage parameters. • Do not store the product and accessories exposed to direct sunlight and heat sources.
NOTICE	Handling packaging materials
	<p>The improper disposal of packaging materials may result in environmental damage.</p> <ul style="list-style-type: none"> • Dispose of the packaging material in accordance with the applicable legal requirements and regulations of the country of use.

5.1 Transport

Check the product after transport and after removing the packaging material for possible transit damage. If you detect any such damage, immediately notify the carrier company and the manufacturer or one of its agents.

Transport the product as follows:

- Only transport the product in its original packaging.
- Handle the packaging and the product carefully.
- Observe the transport weight information and markings on the packaging.
- Secure the packaging and the product against slipping and falling during transport.





5.2 Storage

Store the product and accessories as follows:

- Observe the storage parameters in section “4.2 Storage and transport parameters” on page 20.
- Store in a closed, dry and frost-free room.
- Store away from external weather conditions, direct sunlight and heat sources.
- Secure against falling over and vibrations at the storage location.

6. Installation

6.1 Warning notices

DANGER	Use of incorrect replacement element, accessories or materials
	<p>The use of incorrect spare parts, accessories or materials, as well as auxiliary and operating materials, may pose a mortal danger or the danger of severe injuries.</p>
	<ul style="list-style-type: none"> • Only use undamaged original parts, auxiliary and operating materials specified by the manufacturer in carrying out all work. • Only use materials permitted for the specific purpose and suitable tools in proper condition. • Only use pipelines free from dirt, damage and corrosion.
DANGER	Sudden escape of pressurized fluids
	<p>Bursting system parts or contact with rapidly or suddenly escaping fluids can result in death or serious injury.</p>
	<ul style="list-style-type: none"> • Before starting work, bleed the pressurized system and secure it against unintentional pressurization. • A safe area must be set up around the work area during all assembly, installation, maintenance and repair work. • Assemble all pipes and hoses free of mechanical stress. • Before pressurization, check all system connections for leak tightness and retighten them if necessary. • Pressurize the system slowly. • Avoid pressure surges and high pressure differentials.
WARNING	Insufficient qualification
	<p>If personnel have insufficient qualifications, this may result in accidents, personal injury and property damage as well as operating disruptions while working on the product or its accessories.</p>
	<ul style="list-style-type: none"> • All work on the product and accessories must be carried out exclusively by skilled technical personnel specialized in pressure equipment and systems.
WARNING	Improper installation
	<p>Improper assembly of the product and accessories can result in personal injury.</p>
	<ul style="list-style-type: none"> • Mount the product, the accessories, all parts and materials used free of mechanical tension. • Fasten and fix hoses in such a way that they cannot make any percussive movements.

6.2 Installation conditions

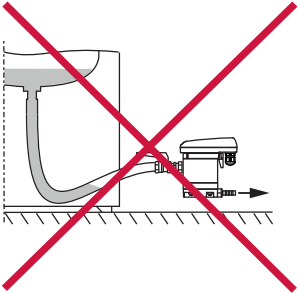
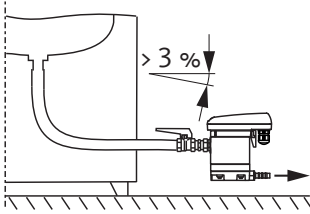
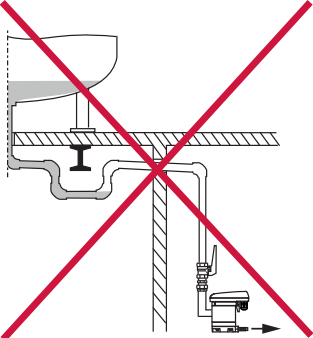
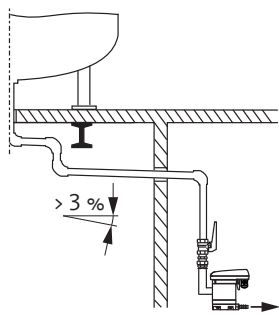
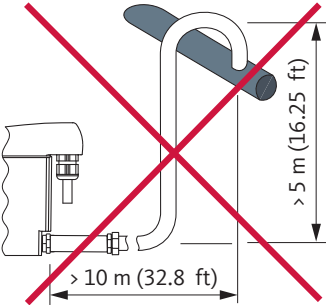
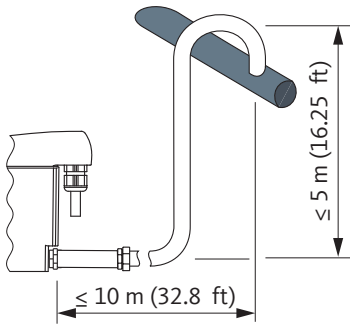
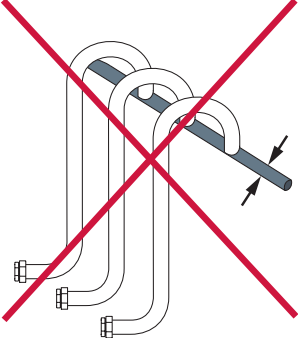
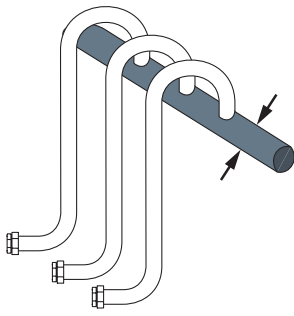
Incorrect	Correct	Description / explanation
		<p>Continuous slope > 3 % in hose lines</p> <ul style="list-style-type: none"> • Ensure a continuous slope > 3% when using hoses as inlet lines. • Make sure that no water pockets form.
		<p>Continuous slope > 3 % in pipe lines</p> <ul style="list-style-type: none"> • Ensure a continuous slope of > 3 % when piping the inlet lines. • Make sure that no water pockets form.
		<p>Drain line characteristics</p> <ul style="list-style-type: none"> • Do not use shut-off valves in the drain line. • Connect the BEKOMAT® only with a hose to the drain line. <ul style="list-style-type: none"> → The hose will compensate for assembly tolerances, vibrations, and thermal expansion. • Do not install the drain line on storage areas or transport areas. • The drain line can have a maximum length of 10 m (32.8 ft) and be routed a maximum of 5 m (16.25 ft) upwards. <ul style="list-style-type: none"> → The minimum operating pressure increases by 0.1 bar(g) (1.5 psi(g)) for each meter of slope.
		<p>Collecting line characteristics</p> <ul style="list-style-type: none"> • The cross-section of the collecting lines must be at least equal to the sum of the individual cross-sections of the connected inlet lines. • Install the collecting line with a continuous slope > 3 %.

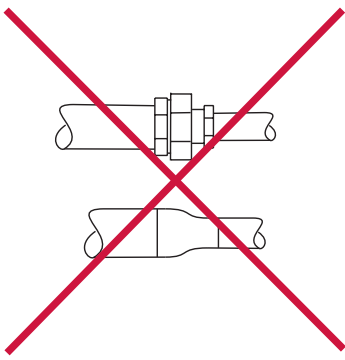
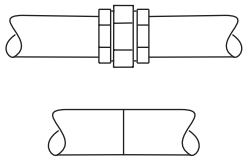
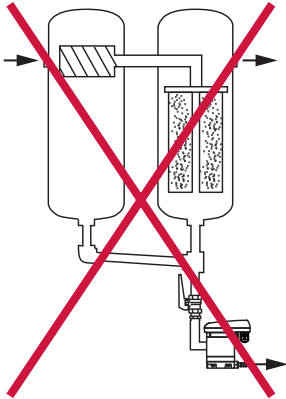
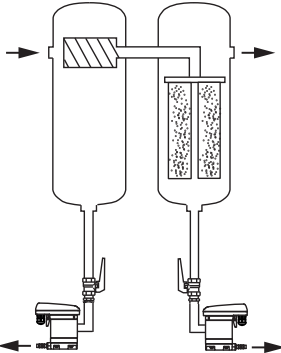
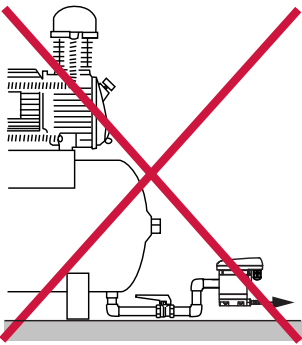
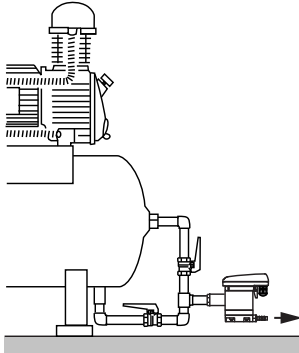
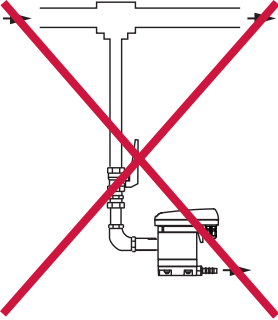
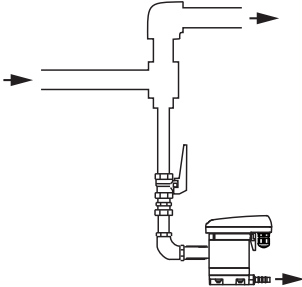
Incorrect	Correct	Description / explanation
		<p>Maintain the minimum pipe diameter</p> <ul style="list-style-type: none"> The minimum inner diameter for the inlet line and the drain line is 13 mm (0.5 in). Do not restrict or reduce the (minimum) pipe diameter with reducers (reducing nipples).
		<p>Bypassing filters</p> <ul style="list-style-type: none"> Drain each condensate accumulation point separately with a BEKOMAT®. Do not create filter bypasses.
		<p>Ensure venting</p> <ul style="list-style-type: none"> In the event of insufficient slope in the inlet or other inlet problems, install a vent line.
		<p>Discharge from pressurized pipelines</p> <ul style="list-style-type: none"> By diverting the gas flow, create a deflecting surface for the discharge of the liquid components in the gas.

6.3 Installation work

The following prerequisites must be met before carrying out assembly work, and all preparation work must be completed first.





Preconditions		
Tool	Material	Protective equipment
<ul style="list-style-type: none"> Open-end wrench or adjustable wrench 	<ul style="list-style-type: none"> Sealing materials e.g. PTFE Inlet line Drain line Hose, inside diameter of 8 to 10 mm (0.31 to 0.39 in), approx. length of 30 cm (1 ft) 	<p>To be worn at all times:</p> 

Preparatory work	
1.	Depressurize the pressurized system or the corresponding system section and secure it against unintentional pressurization.

Installation work	
Image	Description / explanation
<p>The diagram shows a top-down view of the BEKOMAT unit. Two circular callouts, labeled '12' and '9', have arrows pointing to small black plugs. Callout '12' points to a plug in the condensate inlet, labeled 'C'. Callout '9' points to a plug in the condensate drain, labeled 'D'.</p>	<ol style="list-style-type: none"> 1. Remove the plugs [9, 12] from the condensate inlet [C] and condensate drain [D].
<p>The diagram shows a side view of the BEKOMAT unit. A circular callout labeled '8' has an arrow pointing to a barbed hose fitting being inserted into the condensate drain, labeled 'D'.</p>	<ol style="list-style-type: none"> 2. Screw the supplied barbed hose fitting [8] onto the condensate drain [D]. 3. Tighten the barbed hose fitting [8] with a torque of 3 ... 4 Nm (2.21 ... 2.95 ft-lb).

Installation work	
Image	Description / explanation
	<p>Recommendation:</p> <ol style="list-style-type: none"> To allow easy maintenance of the product, install a shut-off valve [X6] in the condensate inlet line [X5]. For the condensate inlet line [X5], seal the end of a pressure-resistant pipe and screw it in at the condensate inlet [C].
	<ol style="list-style-type: none"> For the condensate drain, push the hose [X7] provided onto the barbed hose fitting [8] and fasten it with a hose clamp. Connect the other end of the hose [X7] to the condensate drain line [X8].



7. Electrical installation

DANGER	Use of incorrect replacement element, accessories or materials
	<p>The use of incorrect spare parts, accessories or materials, as well as auxiliary and operating materials, may pose a mortal danger or the danger of severe injuries.</p>
	<ul style="list-style-type: none"> • Only use undamaged original parts, auxiliary and operating materials specified by the manufacturer in carrying out all work. • Only use materials permitted for the specific purpose and suitable tools in proper condition. • Only use electrical components and materials that comply with the regionally applicable legal requirements and regulations for electrical safety.
DANGER	Electrical voltage
	<p>Components in contact with electrical voltage may pose a mortal danger or the danger of severe injuries.</p>
	<ul style="list-style-type: none"> • Always disconnect the product and accessories from the power and secure them against unintentional restart before commencing any installation, maintenance or repair work on them. • A safe area must be set up around the work area during all installation, maintenance and repair work. • Comply with all regionally applicable regulations and requirements during installation. • The power supply must have a disconnect device that is easily accessible and close to the product. This disconnect device must disconnect all live cables. • Connect the protective conductor (earthing) according to regulations.
WARNING	Insufficient qualification
	<p>Allowing insufficiently qualified personnel to work on the product or accessories may lead to accidents and personal injury.</p>
	<ul style="list-style-type: none"> • All work on the product and accessories may only be carried out by qualified electricians.
CAUTION	Improper electrical installation
	<p>Improper electrical installation of the product and accessories can lead to personal injury and property damage as well as impairments in operation.</p>
	<ul style="list-style-type: none"> • Check all plug connections are correctly fitted. • Avoid danger of tripping by routing the cables accordingly. • Avoid mechanical stress on the cables.

WARNING	Ingress of moisture or foreign objects!
	<p>Removing components or opening the product can result in water or foreign objects entering the opened product. The ingress of water or foreign objects can result in accidents, personal injury and property damage, and problems during operation.</p> <ul style="list-style-type: none"> • Protect the product from splash water and moisture. • Only open the product and/or remove components in a dry place. • Do not introduce any foreign objects into the product's openings. • Keep all contact surfaces and openings free of impurities and moisture.

7.1 Connection work

The following requirements must be fulfilled to carry out connection work and preparatory work must be completed.

Preconditions		
Tool	Material	Protective equipment
<ul style="list-style-type: none"> • Stripping tool • Crimping pliers for connecting lines • Screwdriver - Flathead size 2.5 mm (0.09 in) • Torx screwdriver – T15 	<ul style="list-style-type: none"> • 2-wire cable for 230 V power supply • 2-wire cable for 24 V power supply • Connecting lines 	<p>To be worn at all times:</p> <div style="display: flex; justify-content: space-around;">   </div>

Preparatory work	
1.	The installation is completed.

7.1.1 Power supply connection

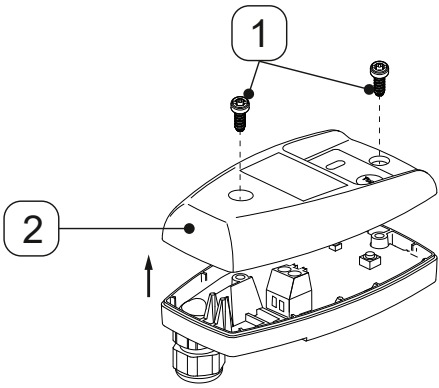

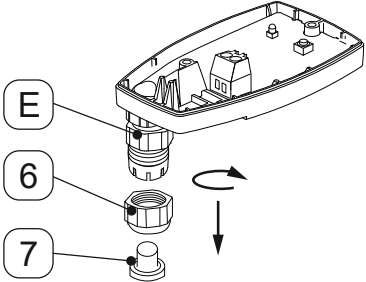
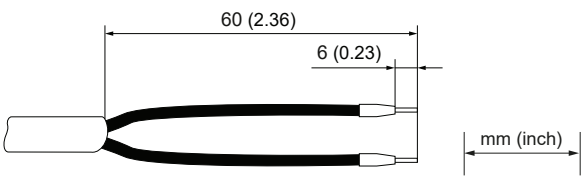
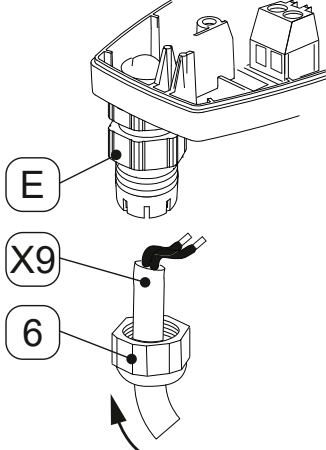
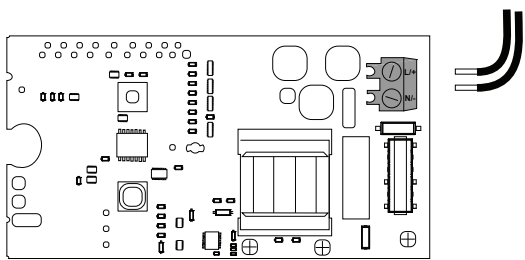

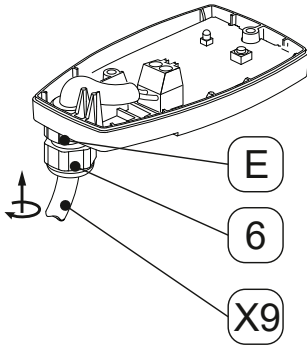
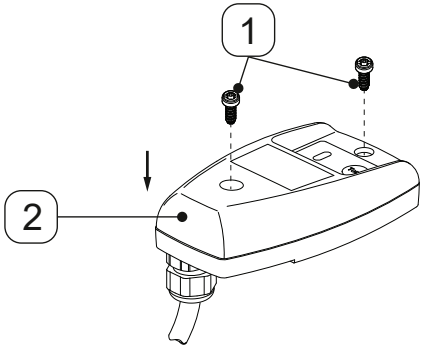
Connection work	
Image	Description / explanation
	<ol style="list-style-type: none"> 1. Remove the 2 screws [1]. 2. Lift the top cover [2].

Connection work	
Image	Description / explanation
	<ol style="list-style-type: none"> 3. Unscrew the locknut [6] from the cable fitting [E]. 4. Remove the plugs [7] from the locknut [6].
<p style="text-align: center;">Connection cable [X9]</p> 	<ol style="list-style-type: none"> 5. Prepare the connection cable [X9].
	<ol style="list-style-type: none"> 6. Insert the locknut [6] over the connection cable [X9]. 7. Insert the connection cable [X9] into the cable fitting [E].
<p style="text-align: center;">Connection cable [X9]</p> 	<ol style="list-style-type: none"> 8. Connect the connection cable [X9] according to the terminal diagram (see "4.7 Terminal diagram" on page 22).

Connection work	
Image	Description / explanation
	<p>9. Tighten the connection cable [X9].</p> <p>10. Screw the locknut [6] onto the cable fitting [E].</p>
	<p>11. Put the top cover [2] in place and insert the screws [1].</p> <p>12. Tighten the screws [1] with a torque of 0.9 Nm +0.5 Nm (0.66 ft-lb +0.37 ft-lb).</p>

8. Commissioning

8.1 Warning notices



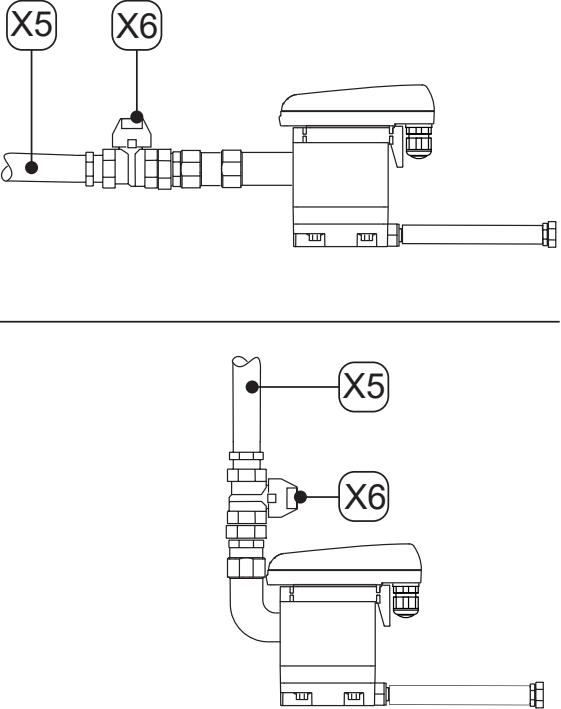

DANGER	Operating outside of permitted limit values
	<p>Operating the product and accessories outside of the permitted limit values and operating parameters, unauthorized modifications and changes may pose a mortal hazard or the danger of severe injuries.</p> <ul style="list-style-type: none"> • Observe the limit values and operating parameters specified on the type plate and in the instructions. • Check whether operating parameters are changed or restricted through the use of accessories.
DANGER	Sudden escape of pressurized fluids
	<p>Bursting system parts or contact with rapidly or suddenly escaping fluids can result in death or serious injury.</p> <ul style="list-style-type: none"> • Before pressurization, check all system connections for leak tightness and retighten them if necessary. • Pressurize the system slowly. • Avoid pressure surges and high pressure differentials.
DANGER	Electrical voltage
	<p>Contact with electrically live components may result in death or serious injury, as well as malfunctions, disruption to operations, or damage to materials.</p> <ul style="list-style-type: none"> • Only operate the product and accessories with a complete and closed cover, closed electronic housing, or closed control cabinet. • Check the product and accessories before placement into operation in accordance with all regionally applicable regulations.
WARNING	Insufficient qualification
	<p>Allowing insufficiently qualified personnel to work on the product or accessories may lead to accidents and personal injury.</p> <ul style="list-style-type: none"> • All work on the product and accessories must be carried out exclusively by skilled technical personnel specialized in pressure equipment and systems and trained electricians.
WARNING	Ingress of moisture or foreign objects!
	<p>Removing components or opening the product can result in water or foreign objects entering the opened product. The ingress of water or foreign objects can result in accidents and personal injury.</p> <ul style="list-style-type: none"> • Protect the product from splash water and moisture. • Only open the product and/or remove components in a dry place. • Do not introduce any foreign objects into the product's openings. • Keep all contact surfaces and openings free of impurities and moisture.

8.2 Commissioning work

Image	Description / explanation
	<ol style="list-style-type: none"><li data-bbox="791 510 1086 544">1. Establish power supply.<li data-bbox="791 591 1374 685">2. Slowly pressurize the system section (e.g., slowly open the recommended shut-off valve [X6] in the condensate inlet line [X5]).<li data-bbox="791 732 1418 797">3. Perform a function test (see “10.3.2 Function test” on page 43).

9. Operation

9.1 Warning notices

DANGER	Operating outside of permitted limit values
	<p>Operating the product and accessories outside of the permitted limit values and operating parameters, unauthorized modifications and changes may pose a mortal hazard or the danger of severe injuries.</p>
	<ul style="list-style-type: none"> • Observe the limit values and operating parameters specified on the type plate and in the instructions. • Observe the installation conditions and ambient conditions. • Check whether operating parameters are changed or restricted through the use of accessories. • Observe the maintenance intervals.
DANGER	Electrical voltage
	<p>Components in contact with electrical voltage may pose a mortal danger or the danger of severe injuries.</p>
	<ul style="list-style-type: none"> • Only operate the product and accessories with a complete and closed cover, closed electronic housing, or closed control cabinet.
WARNING	Ingress of moisture or foreign objects!
	<p>Removing components or opening the product can result in water or foreign objects entering the opened product. The ingress of water or foreign objects can result in accidents and personal injury.</p>
	<ul style="list-style-type: none"> • Protect the product from splash water and moisture. • Only open the product and/or remove components in a dry place. • Do not introduce any foreign objects into the product's openings. • Keep all contact surfaces and openings free of impurities and moisture.
NOTICE	Operating personnel
	<p>Inadequate knowledge of the product and its accessories can lead to material and environmental damage as well as disruptions in operation due to incorrect operation.</p>
	<ul style="list-style-type: none"> • The product and accessories may only be operated and handled by qualified operating personnel.



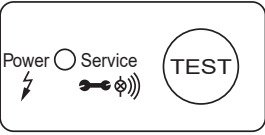
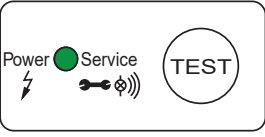
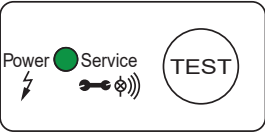
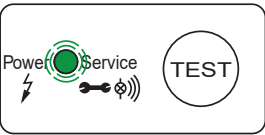

9.2 Operating conditions



Image	Description / explanation
	<p>De-energized</p> <ul style="list-style-type: none"> • LED is off
	<p>Ready for operation (normal operation)</p> <ul style="list-style-type: none"> • The green power LED is on
	<p>Discharge mode</p> <ul style="list-style-type: none"> • The green power LED is on
	<p>Maintenance message</p> <ul style="list-style-type: none"> • The green POWER LED flashes. <ul style="list-style-type: none"> → Change the Service-Unit

For more information on error messages during operation, see section “15. Troubleshooting” on page 52.

10. Maintenance

10.1 Warning notices

DANGER	Sudden escape of pressurized fluids
	<p>Bursting system parts or contact with rapidly or suddenly escaping fluids can result in death or serious injury.</p>
	<ul style="list-style-type: none"> • Before starting work, bleed the pressurized system and secure it against unintentional pressurization. • A safe area must be set up around the work area during all assembly, installation, maintenance and repair work. • Assemble all pipes and hoses free of mechanical stress. • Before pressurization, check all system connections for leak tightness and retighten them if necessary. • Pressurize the system slowly. • Avoid pressure surges and high pressure differentials.
DANGER	Electrical voltage
	<p>Components in contact with electrical voltage may pose a mortal danger or the danger of severe injuries.</p>
	<ul style="list-style-type: none"> • Do not carry out maintenance and repair work on the product unless it has first been de-energized and locked and tagged out. • Establish a safe area around the work area for all maintenance and repair work. • Comply with all regionally applicable regulations and requirements during installation. • Only operate the product and accessories with a complete and closed cover, closed electronic housing, or closed control cabinet.
DANGER	Use of incorrect replacement element, accessories or materials
	<p>The use of incorrect spare parts, accessories or materials, as well as auxiliary and operating materials, may pose a mortal danger or the danger of severe injuries.</p>
	<ul style="list-style-type: none"> • Only use undamaged original parts, auxiliary and operating materials specified by the manufacturer in carrying out all work. • Only use electrical components and materials that comply with the regionally applicable legal requirements and regulations (standards, directives, etc.) for electrical safety. • Only use materials permitted for the specific purpose and suitable tools in proper condition. • Only use cleaned pipelines free from dirt and corrosion.
WARNING	Insufficient qualification
	<p>If personnel have insufficient qualifications, this may result in accidents, personal injury and property damage as well as operating disruptions while working on the product or its accessories.</p>
	<ul style="list-style-type: none"> • All work on the product and accessories may only be carried out by qualified service technicians.

WARNING	Ingress of moisture or foreign objects!
	<p>Removing components or opening the product can result in water or foreign objects entering the opened product. The ingress of water or foreign objects can result in accidents, personal injury and property damage, and problems during operation.</p> <ul style="list-style-type: none"> • Protect the product from splash water and moisture. • Only open the product and/or remove components in a dry place. • Do not introduce any foreign objects into the product's openings. • Keep all contact surfaces and openings free of impurities and moisture.
DANGER	Water coming into contact with live parts
	<p>Water contact with live parts may result in death or serious injury. It may also result in malfunctions, disruption to operations, and damage to materials.</p> <ul style="list-style-type: none"> • Protect the product from splash water and moisture. • Do not clean the product using pressure washers or steam jet cleaners.

10.2 Maintenance plan

Maintenance	Interval
Change the Service-Unit	After 2 x 8760 operating hours or 1 million switching cycles*; at the latest every 2 years
Cleaning	Annually
Function test	Monthly
Visual inspection	Weekly
Leak test	After installation work, maintenance work and servicing work on the product

* based on 7 bar(g) (101.5 psi(g)) and pH-neutral condensate

10.3 Maintenance work

The following requirements must be fulfilled to carry out maintenance work and preparatory work must be completed.

Preconditions		
Tool	Material	Protective equipment
<ul style="list-style-type: none"> • Screwdriver - Flathead size 2.5 mm (0.09 in) • Open-end wrench or adjustable wrench 	<ul style="list-style-type: none"> • Sealants • Lubricant for greasing the O-rings • Mild cleaning agent • Cotton cloth or disposable cloth 	<p>To be worn at all times:</p> 

10.3.1 Service-Unit change

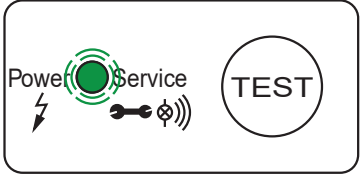
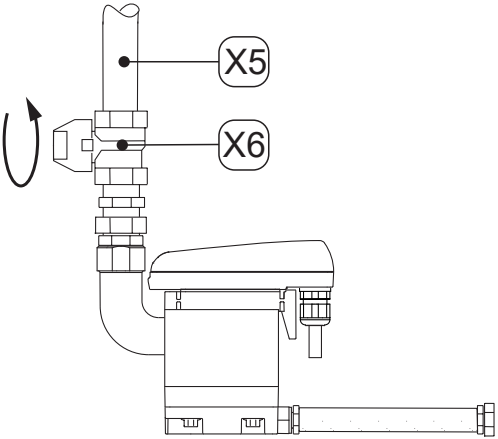
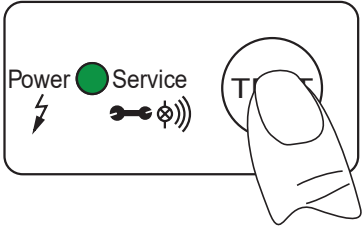
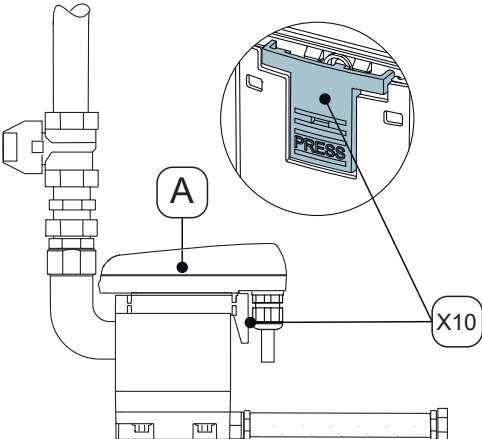
Replacement work	
Image	Description / explanation
	<ol style="list-style-type: none"> 1. The green POWER LED will flash in order to indicate the need for maintenance.
	<ol style="list-style-type: none"> 2. Shut off the condensate supply through the condensate inlet line [X5] (e.g., close the recommended shut-off valve [X6]).
	<ol style="list-style-type: none"> 3. Briefly press the TEST button several times. <ul style="list-style-type: none"> → The pressure in the BEKOMAT® is reduced. → The remaining condensate in the BEKOMAT® is drained off.
	<ol style="list-style-type: none"> 4. Release the control unit [A] by pressing the latching tab [X10].

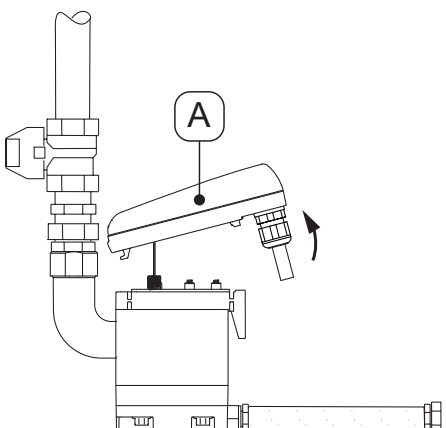
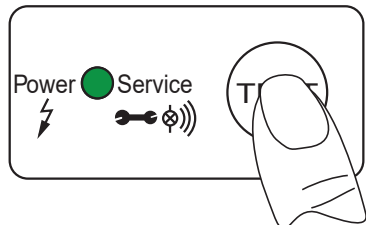
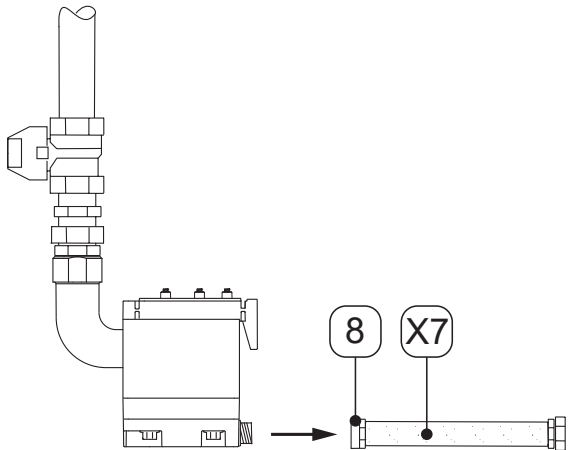
Replacement work	
Image	Description / explanation
	<p>5. Remove the control unit [A].</p>
	<p>6. Press the TEST button on the control unit [A] and keep it pressed for at least 5 seconds. → The green POWER LED flashes</p> <p>7. As soon as the green POWER LED lights up permanently, stop pressing the TEST button. → The “service time” counter has now been reset.</p> <p>8. Carefully put the control unit [A] aside.</p>
	<p>9. Loosen the barbed hose fitting [8] with the hose [X7].</p>

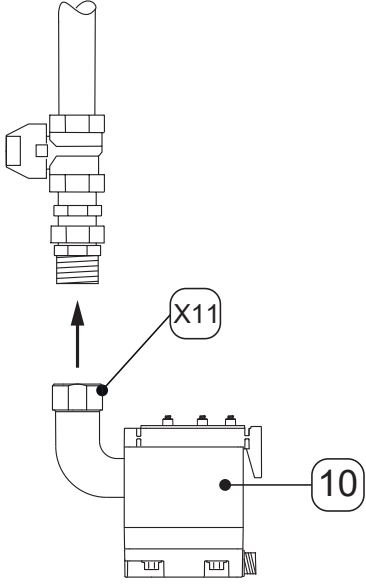
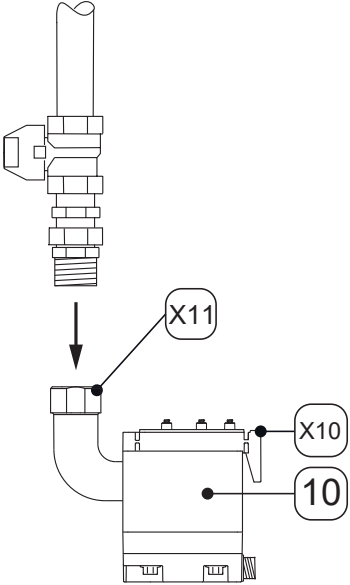
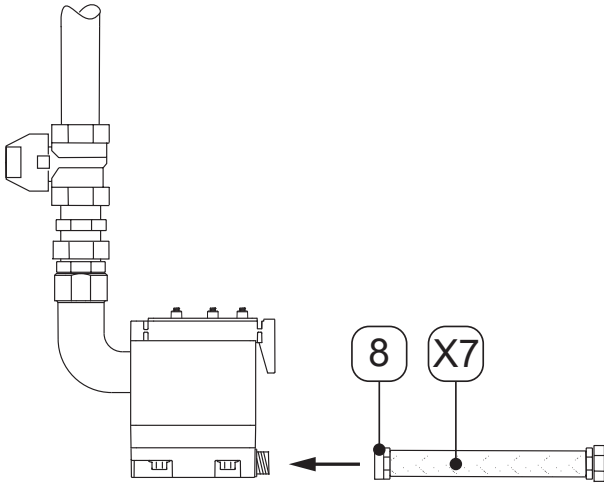
Replacement work	
Image	Description / explanation
	<p>10. Remove the Service-Unit [10] from the pipework at the condensate inlet by loosening the union nut [X11].</p> <p>11. Dispose of the old Service-Unit properly (see “14. Disposal” on page 50).</p>
	<p>12. Check whether the new Service-Unit [10] fits the control unit [A]:</p> <ul style="list-style-type: none"> → Type designation → The color of the latching tab [X10] is identical to the color of the control unit. <p>13. Pipe the new Service-Unit [10] to the condensate inlet.</p> <p>14. Tighten the union nut [X11].</p>
	<p>15. Mount the barbed hose fitting [8] with the hose [X7].</p>

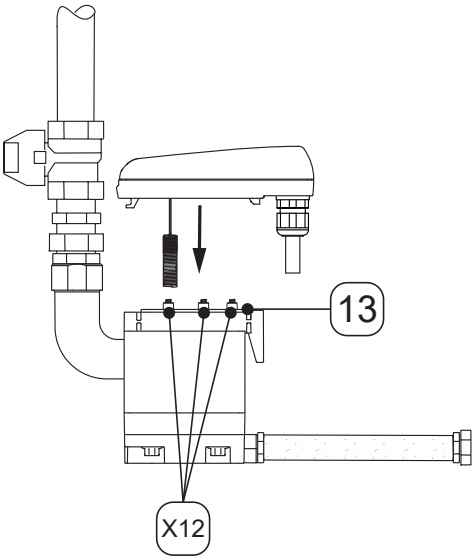
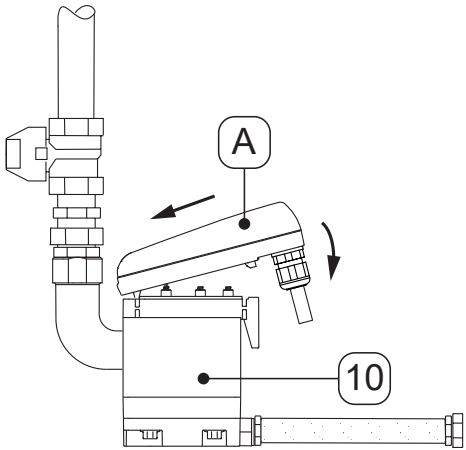
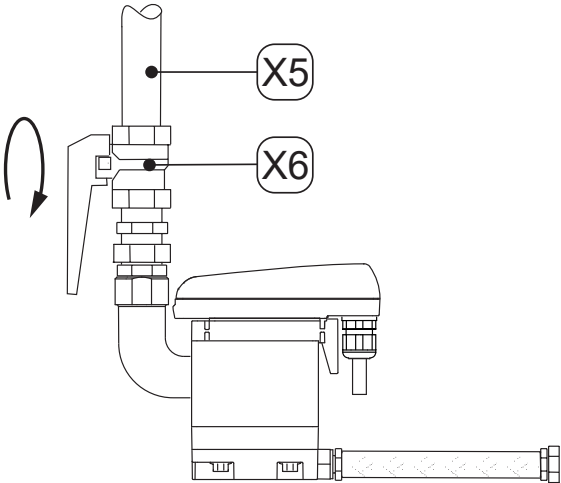
Replacement work	
Image	Description / explanation
 <p>The diagram shows a side view of the BEKOMAT 31U unit. A sensor mat, labeled [13], is being pushed into a sensor tube opening, labeled [X12]. The mat has three contact springs. Arrows indicate the direction of insertion.</p>	<p>16. Check that the sealing mat [13] with the contact springs [X12] is clean, dry, and free of foreign objects.</p> <p>17. Insert the sensor of the control unit [A] into the sensor tube opening.</p>
 <p>The diagram shows the control unit, labeled [A], being inserted into the Service-Unit, labeled [10]. The control unit has a hook that fits into the Service-Unit. Arrows indicate the insertion direction.</p>	<p>18. Insert the hook of the control unit [A].</p> <p>19. Press the control unit [A] against the Service-Unit [10] and snap it into place.</p>
 <p>The diagram shows the condensate inlet lines, labeled [X5], and the recommended shut-off valve, labeled [X6]. A curved arrow indicates the valve being turned to open the supply.</p>	<p>20. Perform a leak test on all screw connections.</p> <p>21. Carefully open the condensate supply through the condensate inlet lines [X5] (e.g., open the recommended shut-off valve [X6]).</p>

10.3.2 Function test

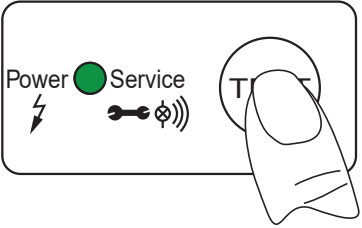
Image	Description / explanation
 The diagram shows a control panel with three buttons: 'Power' with a lightning bolt icon, 'Service' with a green circle icon, and 'TEST' with a circular icon containing 'T'. A hand is shown pressing the 'TEST' button.	<p>Press the TEST button for 2 ... 5 seconds.</p> <ul style="list-style-type: none">→ The green power LED is on→ The valve opens and condensate is discharged



10.3.3 Visual inspection

During the visual inspection of the product, check all components for mechanical damage and corrosion. Replace damaged components immediately.

10.3.4 Leak test

The leak test is a non-destructive testing method and is used to prove the leak tightness of vacuum and overpressurized systems. The leak test can be completed in different ways. The manufacturer does not recommend any specific method over another. The selection and determination of the test procedure is the responsibility of the company operating the pressurized system and must be carried out in conformity with the applicable standards and guidelines (e.g., DIN EN 1779).

10.3.5 Cleaning

CAUTION	Risk of personal injury through improper use of cleaning agents
	<p>Improper use cleaning agents may result in minor injuries and damage to health.</p> <ul style="list-style-type: none"> • Never clean the device with a wet cloth. • Do not clean the product using a pressure washer. • Do not use abrasive or aggressive cleaning agents or solvents that could damage the external coating (e.g. labels, type plate, corrosion protection, etc.). • Do not clean or operate the device with hard or pointed implements. • Use an antistatic, damp cloth for external cleaning. • Replace illegible product labels (pictograms, designations) promptly. • Use personal protective equipment. • Use cleaning agents in accordance with the manufacturer's instructions.
NOTICE	Observe the local hygiene regulations
	In addition to the cleaning instructions listed, any regionally applicable or company-specific hygiene regulations must be observed.

Preparatory work

1.	Decommissioning is completed.
----	-------------------------------

Cleaning work

1.	Spray mild cleaning agent onto a cotton cloth or disposable cloth until it is damp (not wet).
2.	Wipe the surfaces of the product with the damp cloth.
3.	Put the product into operation.

11. Consumables, accessories and spare parts

11.1 Order information

The manufacturer's service staff will need the following information for an inquiry or order:

- Serial number (see type plate)
- Material number and designation of the accessory or spare part
- Desired number of accessories or spare parts to be supplied

The contact information for the manufacturer's service department is listed in section "1.1 Contact" on page 4.

11.2 Accessories

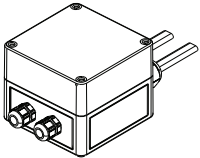
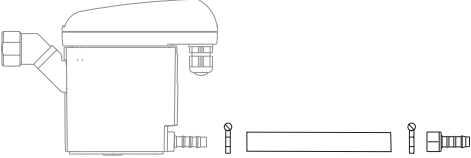

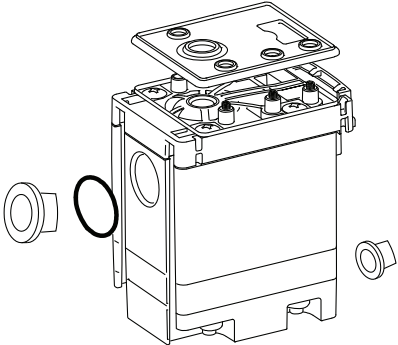
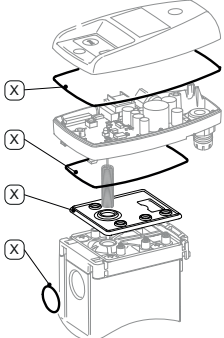

Image	Description / explanation	Material no.
	Pipe trace heating 230 VAC	4041657
	Drain kit	2000045

11.3 Spare parts

Image	Description / explanation	Material no.
	BEKOMAT® 31U Service-Unit	4023607
	Sealing kit (includes the components marked with an [X])	4024386

12. Decommissioning

12.1 Warning notices

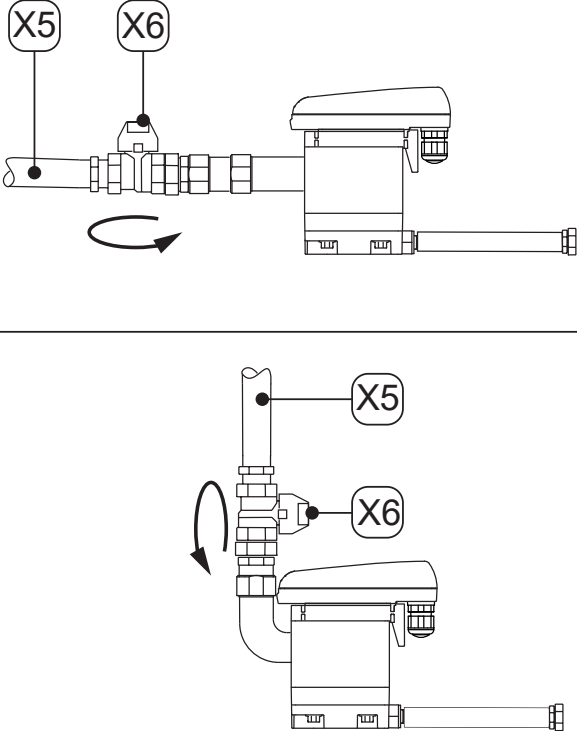
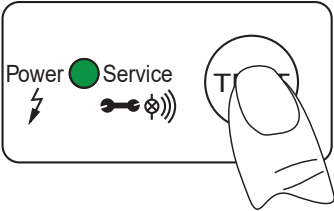

DANGER	Sudden escape of pressurized fluids
	<p>Bursting system parts or contact with rapidly or suddenly escaping fluids can result in death or serious injury.</p> <ul style="list-style-type: none"> • Establish a safe area around the work area before starting work. • Before starting work, bleed the pressurized system and secure it against unintentional pressurization.
DANGER	Electrical voltage
	<p>Contact with electrically live components may result in death or serious injury, as well as malfunctions, disruption to operations, or damage to materials.</p> <ul style="list-style-type: none"> • Establish a safe area around the work area before starting work. • Before starting work, de-energize the product and the accessories and lock and tag them out.
WARNING	Insufficient qualification
	<p>Allowing insufficiently qualified personnel to work on the product or accessories may lead to accidents and personal injury.</p> <ul style="list-style-type: none"> • All work on the product and accessories may only be carried out by qualified service technicians.
WARNING	Ingress of moisture or foreign objects!
	<p>Removing components or opening the product can result in water or foreign objects entering the opened product. The ingress of water or foreign objects can result in accidents and personal injury.</p> <ul style="list-style-type: none"> • Protect the product from splash water and moisture. • Only open the product and/or remove components in a dry place. • Do not introduce any foreign objects into the product's openings. • Keep all contact surfaces and openings free of impurities and moisture.

12.2 Decommissioning work

Image	Description / explanation
	<ol style="list-style-type: none"> 1. Shut off the condensate supply through the condensate inlet line [X5] (e.g., close the recommended shut-off valve [X6]).
	<ol style="list-style-type: none"> 2. Briefly press the TEST button several times. <ul style="list-style-type: none"> → The pressure in the BEKOMAT® is reduced. → The remaining condensate in the BEKOMAT® is drained off. 3. Disconnect the BEKOMAT® from the power supply and switch it off.



13. Disassembly

13.1 Warning notices

DANGER	Sudden escape of pressurized fluids
	<p>Bursting system parts or contact with rapidly or suddenly escaping fluids can result in death or serious injury.</p> <ul style="list-style-type: none"> • Establish a safe area around the work area before starting work. • Before starting work, bleed the pressurized system and secure it against unintentional pressurization.
DANGER	Electrical voltage
	<p>Contact with electrically live components may result in death or serious injury, as well as malfunctions, disruption to operations, or damage to materials.</p> <ul style="list-style-type: none"> • Establish a safe area around the work area before starting work. • Before starting work, de-energize the product and the accessories and lock and tag them out.
WARNING	Insufficient qualification
	<p>Allowing insufficiently qualified personnel to work on the product or accessories may lead to accidents and personal injury.</p> <ul style="list-style-type: none"> • All work on the product and accessories may only be carried out by qualified service technicians.

13.2 Disassembly work

The following requirements must be fulfilled to carry out disassembly work and preparatory work must be completed.

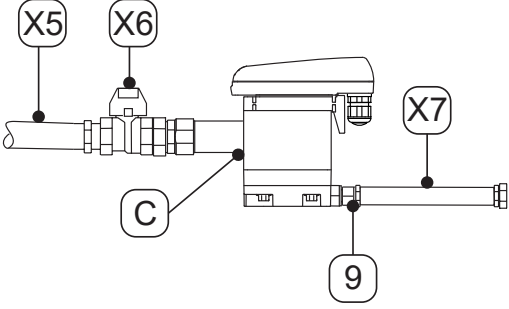
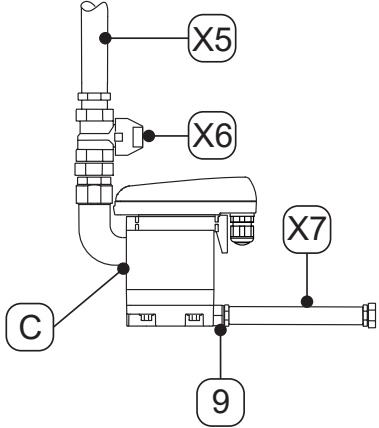

Preconditions		
Tool	Material	Protective equipment
<ul style="list-style-type: none"> • Open-end wrench or adjustable wrench 	<ul style="list-style-type: none"> • No material necessary 	<p>To be worn at all times:</p> <div style="display: flex; justify-content: space-around; align-items: center;">    </div>
Preparatory work		
1.	Decommissioning is completed.	
2.	Depressurize the pressurized system or the corresponding system section and secure it against unintentional pressurization.	

Disassembly work	
Image	Description / explanation
	<ol style="list-style-type: none">1. Disconnect the hose [X7] from the barbed hose fitting [9] and remove it.
	<ol style="list-style-type: none">2. Disconnect and remove the condensate inlet line [X5] and the recommended shut-off valve [X6] from the condensate inlet [C].3. Disassemble all electrical connections.

14. Disposal

The product and accessories must be properly disposed of at the end of their useful life, e.g., by a specialized company. Materials such as glass, plastic, and some chemical compounds can be recycled or reused.

14.1 Warning notices

NOTICE	Improper disposal
	<p>Improper disposal of components and assemblies, operating, auxiliary materials and cleaning agents may cause environmental hazards.</p>
	<ul style="list-style-type: none"> • All components, assemblies, operating, auxiliary materials and cleaning agents must be disposed of appropriately and according to regional statutory specifications and provisions. • Dispose of electrical and electronic components through a specialized disposal company or return them to the manufacturer. • In case of doubt, consult a regional disposal company before disposal.
INFORMATION	Disposal of electrical and electronic products
	<p>Electrical and electronic products (EEE) contain materials, components and substances that can be hazardous and harmful to human health and the environment if the waste from electrical and electronic products (WEEE) is not properly disposed of.</p>
	<p>Electrical and electronic products are marked with the crossed-out waste container. The crossed-out garbage bin symbolizes that electrical and electronic products must be collected separately and not disposed of together with unsorted household waste.</p>
	<p>For more information regarding regionally applicable regulations and requirements for the recycling of electrical and electronic products, contact regional waste disposal companies or the appropriate authorities.</p>

14.2 Disposal of operating fluids and auxiliary materials

Operating material / auxiliary material	EU waste code
Adsorbent materials, filter materials, wiping cloths and protective clothing - contaminated with oils or other hazardous substances	15 02 02
Adsorbent materials, filter materials, cleaning wipes and protective clothing, unless classified under 15 02 02	15 02 03
Packaging - Paper and cardboard	15 01 01
Packaging - Plastics	15 01 02
Waste oils - mineral	13 02 05
Waste oils - synthetic	13 02 06

14.3 Disposal of components

The following requirements must be met before disposal:

Preconditions	
1.	The product and accessories have been taken out of service and dismantled.
2.	The product and the accessories are cleaned and freed from existing media residues.

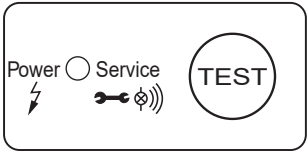
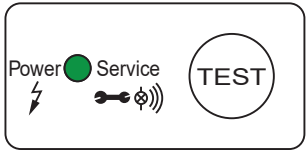
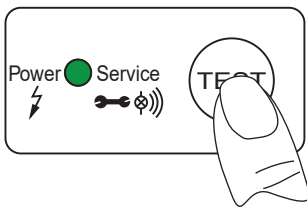
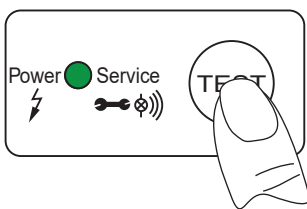
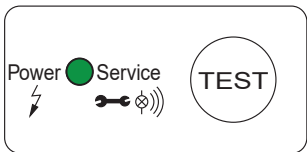

Components	EU waste code
Electrical and electronic equipment - other than those mentioned in 20 01 21, 20 01 23 and 20 01 35	20 01 36
Plastics	20 01 39
Metals	20 01 40

15. Troubleshooting

Symptoms	Possible causes	Troubleshooting
	<ul style="list-style-type: none"> No LED lit 	<ul style="list-style-type: none"> Read and check the operating voltage on the type plate Check whether there is voltage at the sensor board terminals (L, N) Check the plug connection on the cable terminal on the sensor board
	<ul style="list-style-type: none"> The green power LED shows a solid green light. 	<ul style="list-style-type: none"> Disconnect the product from the operating voltage and reconnect it after > 5 seconds. Check the sensor board for possible damage.
	<ul style="list-style-type: none"> No condensate is discharged after pressing the TEST button. 	<ul style="list-style-type: none"> Check the inlet and drain lines Check the valve's operation by pressing the TEST button. <ul style="list-style-type: none"> → The switching of the valve is clearly audible (clacking noise). Exchange the Service-Unit Check the plug connection on the cable terminal on the sensor board
	<ul style="list-style-type: none"> Condensate is only discharged when the TEST button is pressed. 	<ul style="list-style-type: none"> Install the inlet line with a gradient >3%. Install a vent line Check whether the required minimum pressure is reached (see "4. Technical data" on page 19). Exchange the Service-Unit
	<ul style="list-style-type: none"> The BEKOMAT® is draining continuously without stopping. 	<ul style="list-style-type: none"> Exchange the Service-Unit

16. Appendices

16.1 Certificates and declarations of conformity

Symbol	Description / explanation
	<p>FCC marking</p> <p>The FCC mark identifies a product that complies with the requirements of the Federal Communications Commission (FCC) and confirms that basic health and safety requirements have been complied with during the manufacture of the product. The product may be sold on the US market.</p>
	<p>cTÜVus marking</p> <p>The cTÜVus marking identifies a product that meets the requirements of TÜV Rheinland for the Canadian and US markets and confirms that basic health and safety requirements have been complied with during the manufacture of the product. The product may be sold on the Canadian and US markets.</p>
	<p>WEEE marking</p> <p>The crossed-out waste bin marks an electrical or electronic product that must not be disposed of in household waste at the end of its service life. Free collection points for old electrical and electronic products are available for returning the product, as well as other collection points for reusing the product, if necessary. Addresses can be obtained from the local government.</p>

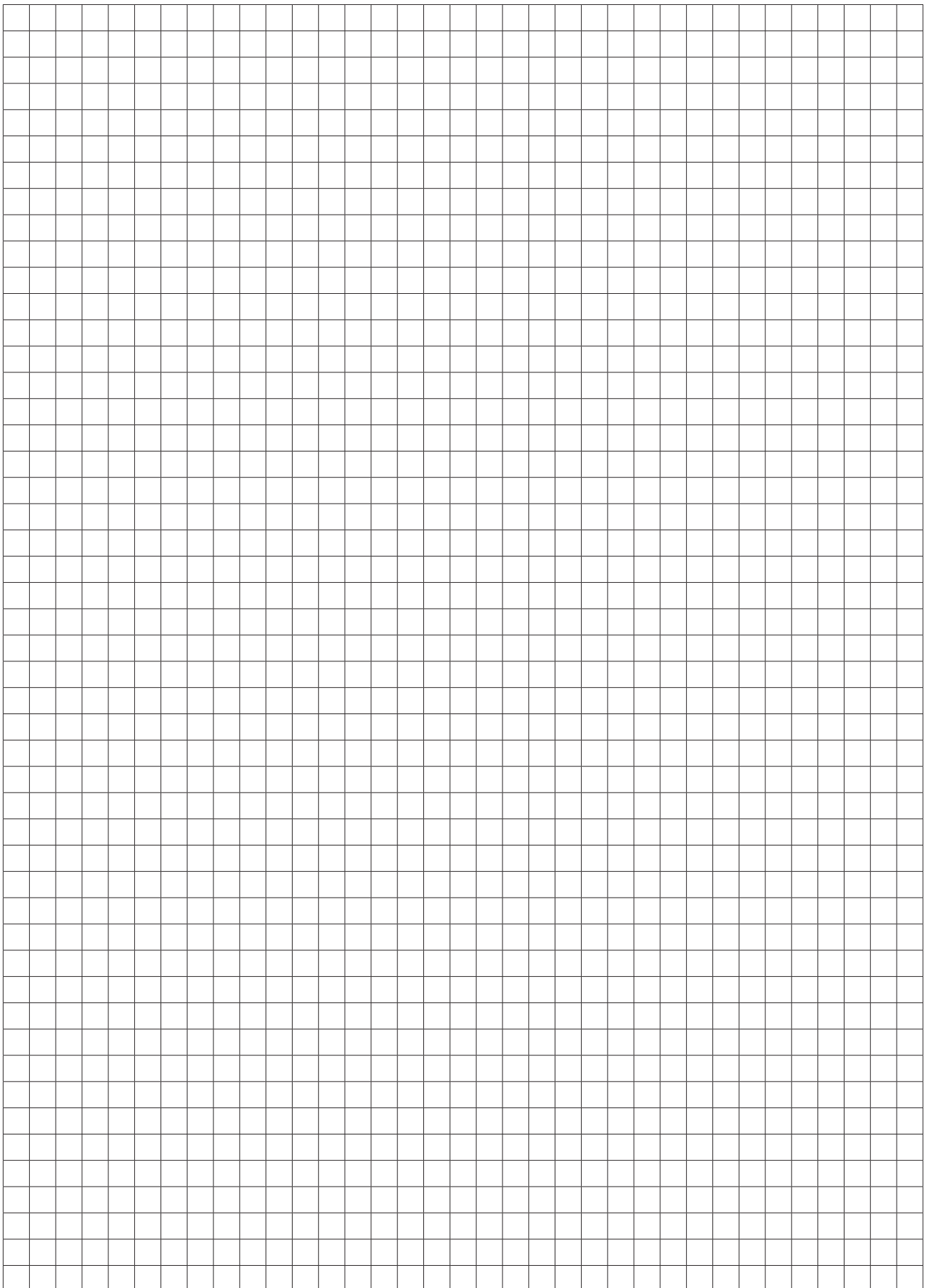

BEKO TECHNOLOGIES, CORP.

900 Great Southwest Pkwy SW
Atlanta, GA 30336
USA
Tel. +1 404 924-6900
beko@bekousa.com

US

BEKO TECHNOLOGIES S. de R.L. de C.

BEKO Technologies, S de R.L. de C.V.
Blvd. Vito Alessio Robles 4602 Bodega 10
Zona Industrial
Saltillo, Coahuila, 25107
Mexico
Tel. +52(844) 218-1979
informacion@beko-technologies.com **MX**

