

Original installation and operation manual

BEKOMAT® 32U Vario IF Built-in

> BM32UVIFBI

■ Table of contents

1. Notes about the documentation	4
1.1 Contact	4
1.2 Information about this installation and operation manual	4
2. Safety	5
2.1 Use	5
2.1.1 Intended use	5
2.1.2 Reasonably foreseeable inappropriate use	6
2.2 Responsibility of the operating company	6
2.3 Target group and personnel	7
2.4 Explanation of the safety symbols used	8
2.5 Safety and warning notices	9
2.5.1 General applicable safety instructions	9
2.5.2 Safe operation	9
2.5.3 Pressurised systems	10
2.5.4 Electric voltage	10
2.5.5 Transport and storage	11
2.5.6 Installation	11
2.5.7 Maintenance	12
2.5.8 Handling hazardous substances	12
2.5.9 Working on electronic components	12
2.5.10 Use of spare parts, accessories or materials	13
2.6 Warning notices	13
3. Product information	14
3.1 Product overview	14
3.2 Exploded drawing	15
3.3 Function description	16
3.4 Type plate	18
3.5 Scope of delivery	19
4. Technical data	20
4.1 Operating parameters	20
4.2 Storage and transportation parameters	21
4.3 Materials	21
4.4 Screw fastening torques	21
4.5 Dimensions	22
4.6 Installation dimensions	23
4.7 Terminal diagram	23
5. Transport and storage	24
5.1 Transport	24
5.2 Storage	24
6. Assembly	25
6.1 Warning notices	25
6.2 Assembly conditions	26
6.3 Assembly work	28

7. Electrical installation	30
7.1 Warning notices	30
7.2 Connection work	31
7.2.1 Voltage supply connection	31
8. Commissioning	33
8.1 Warning notices	33
8.2 Commissioning work.....	34
9. Operation	35
9.1 Warning notices	35
10. Maintenance	36
10.1 Warning notices	36
10.2 Maintenance schedule	37
10.3 Maintenance work	37
10.3.1 Changing the Service-Unit	37
10.3.2 Visual inspection.....	41
10.3.3 Leakage test	41
10.3.4 Cleaning	42
11. Consumables, accessories and spare parts	43
11.1 Order information.....	43
11.2 Accessories.....	43
11.3 Spare parts.....	44
12. Decommissioning	45
12.1 Warning notices	45
12.2 Decommissioning work	45
13. Disassembly	46
13.1 Warning notices	46
13.2 Disassembly work	46
14. Disposal	48
14.1 Warning notices	48
14.2 Disposal of operating and auxiliary materials	49
14.3 Disposal of components	49
15. Troubleshooting	50
16. Appendices	51
16.1 Approval certificates and declarations of conformity.....	51
16.2 Declaration of Conformity.....	52
17. Notes	55

1. Notes about the documentation

This documentation contains all the necessary steps for the use and operation of the product and the accessories.

1.1 Contact

Manufacturer	Customer service and tools
BEKO TECHNOLOGIES GmbH Im Taubental 7 41468 Neuss Phone: +49 2131 988-1000 info@beko-technologies.com www.beko-technologies.com	BEKO TECHNOLOGIES GmbH Im Taubental 7 41468 Neuss Phone: +49 2131 988-1000 service-eu@beko-technologies.com www.beko-technologies.com

INFORMATION	Country-specific manufacturer representation
	You can contact the country-specific manufacturer's representative via the address listed in the address section on the rear cover or by using the contact form on the manufacturer's website.

1.2 Information about this installation and operation manual

INFORMATION	Copyright protection!
	The contents of the installation and operation manual in the form of text, figures, illustrations, photographs, technical drawings, diagrams and other representations are protected by the copyright of the manufacturer. The distribution as well as the duplication of this document, the exploitation and the communication of its contents are prohibited unless expressly authorised.

Publication date	Revision	Version	Reason for amendment	Scope of amendment
1 August 2022	03	00	Editorial revision	Editorial changes

The installation and operation manual, hereinafter referred to as the manual, must always be kept close to the product and be in a permanently legible condition.

The manual must be handed over along with the product if it is sold or passed on.

NOTE	Follow the instructions given in the manual!
	This manual contains all the basic information required for safe operation of the product and must be read before any actions are performed. Otherwise personal and material hazards as well as malfunction and device failure are possible.

2. Safety

2.1 Use

The **BEKOMAT® 32U Vario IF Built-in**, also referred to in the following as the product or **BEKOMAT®**, is an electronically level-controlled condensate drain used for discharging condensate in pressurised systems. The **BEKOMAT®** is able to drain condensate at operating pressure with no pressure loss.

2.1.1 Intended use

Any use of this system other than the use described in this manual is hereby deemed to be non-intended and can cause a hazard for the safety of people and the environment.

The following must be noted for intended use:

- Read and follow the manual.
- Only use the product and the accessories in indoor areas.
- Only use the product and accessories within the operating parameters given in the technical data.
- Only use the product and accessories within the agreed delivery conditions.
- Only use the product and accessories with media which are free of caustic, aggressive, corrosive, toxic, flammable, oxidising and inorganic components. In cases of doubt an analysis must be carried out.
- Only use the product and accessories in surroundings where splash water is the maximum possible water exposure that can occur. The splash water must be free of corrosive components.
- Only use the product and accessories in areas which are free of toxic and corrosive chemicals and gases.
- Only use the product and accessories within the piping system designed for the technical data with appropriate connections, pipe diameters and assembly clearances.
- Only use the product and accessories outside potentially explosive atmospheres.
- Only use the product and accessories away from direct solar radiation and heat sources as well as areas subject to frost.
- Only combine the product and the accessories with the recommended manufacturer products and components indicated in this manual.
- Adhere to the prescribed maintenance schedule.

Before using the product and the accessories, the operating company must make sure that all conditions and prerequisites for intended use are given.

The product and the accessories have been exclusively designed for stationary use in a commercial or industrial area. All of the assembly, installation, operation, maintenance, disassembly and disposal work described may only be performed by qualified skilled technical personnel.

2.1.2 Reasonably foreseeable inappropriate use

A case of reasonably foreseeable inappropriate use is deemed to have occurred if the product or the accessories are used in any other way than that described in the "Intended use" section. Reasonably foreseeable inappropriate use includes the use of the product or the accessories in a manner not intended by the manufacturer or supplier but which may result from foreseeable human behaviour.

Reasonably foreseeable inappropriate use includes:

- The execution of any kind of modification, in particular constructive and process-technology related interventions.
- The suspension, bridging or non-application of existing or recommended safety equipment.
- Using the product and accessories in piping systems with carbon dioxide as the operating medium.

This list is not exhaustive as not all possible inappropriate use can be foreseen in advance. If the operating company is aware of any inappropriate use of the product or accessories which are not listed here, the manufacturer must be informed immediately.

2.2 Responsibility of the operating company

The responsible operating company must ensure the following to prevent accidents, incidents and adverse effects on the environment:

- Before all actions, check to ensure that the manual available does in fact belong to the product.
- The product and the accessories are used, serviced and repaired in accordance with the intended use.
- The product and accessories are only used with the recommended and fully operable safety equipment.
- All assembly, installation and maintenance work is carried out by qualified skilled technical personnel only.
- Personnel have the necessary personal protective equipment available and also use this equipment.
- Suitable technical safety measures are taken so that the permissible operating parameters are adhered to.
- Keep all safety symbols and the type plate on the product in a legible state. Replace damaged and illegible marking immediately.

2.3 Target group and personnel

This manual addresses the personnel listed below who are involved with work on the product or the accessories.

INFORMATION	Personnel requirements!
	<p>The personnel may not execute any actions on the product or the accessories when they are under the influence of drugs, medications, alcohol or other substances that may impair their consciousness.</p>

Operating personnel

Operating personnel are persons who are able to operate the product and the accessories safely on the basis of knowledge of the manual and instruction at the product and accessories. Operating personnel can recognise possible malfunctions and dangerous situations independently and arrange for corresponding measures.

Skilled technical personnel - transport and storage

Skilled technical personnel - transport and storage are people who, due to their training, professional experience and qualifications, have all the necessary skills to safely execute all actions in connection with the transport and storage of the product, to instruct, to recognise possible dangerous situations independently and to execute measures to avoid danger.

The skills required include, in particular, experience operating hoists, forklifts and lifting equipment and familiarity with locally applicable laws, standards and guidelines relating to transport and storage.

Skilled technical personnel - pressure equipment and plants

Skilled technical personnel specialising in pressure equipment and plants are people who, as a result of their training, professional experience, qualifications and further training, have all the requisite skills to safely perform all actions related to pressurised fluids and systems, to instruct, to independently identify potentially hazardous situations, and to implement appropriate measures to avert any danger.

The skills required include, in particular, experience using measuring equipment and control equipment, as well as familiarity with locally applicable laws, standards and regulations for pressurised systems.

Skilled technical personnel - electrical engineering

Skilled technical personnel specialising in electrical engineering are people who, as a result of their training, professional experience, qualifications and further training, have all the requisite skills to safely perform all actions related to electricity, to instruct and to independently identify potentially hazardous situations and to take appropriate measures to avert any danger.









The skills required include, in particular, experience in using electrical plants, measurement and control technology as well as familiarity with locally applicable laws, standards and regulations (e.g. VDE 0100 / IEC 60364 / ATEX) applicable for dealing with electrical technology.

Skilled technical personnel - customer service

Skilled technical personnel - customer service are people who have the skills and qualifications of the skilled personnel definitions named above. Skilled technical personnel - customer service must have documented proof of training for all work on the product and be authorised.

2.4 Explanation of the safety symbols used

The symbols used below indicate safety-relevant and important information which must be adhered to when handling the product and to ensure safe and optimum operation.

Symbol	Description / explanation
	General warning symbol (danger, warning, caution)
	Warning: pressurised system
	Warning: electric voltage
	Observe the installation and operation manual
	General note
	Wear safety footwear
	Use protective gloves (cut-proof and liquid-resistant)
	Wear safety goggles with side shields
	General information

2.5 Safety and warning notices

This section provides an overview of all the important safety aspects for personal protection as well as for the safe and problem-free operation of the product and accessories.

The following sections list the dangers posed by this product and the accessories even with intended use. To minimise the risk of personal injury and damage to property and to avoid dangerous situations, observe the safety instructions listed and adhere to the warning notices in the other sections of this manual.

Basic warning notices and the necessary qualifications of skilled technical personnel are always listed at the beginning of the section in the “Warning notices” section.

Warning notices related to specific actions are printed directly before potentially hazardous procedures or sequences of actions.

2.5.1 General applicable safety instructions

- Before starting work, refer to the technical documentation for the entire system and observe the overall operating instructions.
- Carry out a risk assessment before starting work on site (last minute risk assessment).
- Use suitable personal protective equipment (PPE) for all work.
- Set up a safety area around the working area during all installation, maintenance and repair work.
- Use existing plant-specific Lockout Tagout (LOTO) procedure for safe shutdown and isolation from energy hazards.

2.5.2 Safe operation

The following actions may result in serious personal injury or death:

- Commissioning and operation of the product and accessories outside the permissible limit values and operating parameters
- Unauthorised interference and unauthorised modifications of the product and accessories

To guarantee safe operation of the product and accessories, observe the following points:

- Observe the limits and operating parameters specified on the type plate and in the manual.
- Check whether the permissible operating parameters have been changed or restricted by the use of accessories.
- Observe the assembly conditions and the ambient conditions.
- Adhere to the maintenance intervals.

2.5.3 Pressurised systems

The following may result in serious personal injury or death:

- Contact with fast or suddenly escaping fluids
- Bursting system parts
- Whipping movements of pressurized hoses and pipes during separation

For the safe handling of pressurised systems, observe the following points:

- Observe the following safety rules during all work:
 1. Shut down system or system section
 2. Secure system or system section against restarting
 3. Reduce pressure in the system or all system sections to ambient pressure
 - e.g. by slowly releasing the pressure in a controlled manner via relief valves
 4. Secure against pressure being applied again
- Check pressurised systems for safety, contamination and possible damage.
- Before pressurisation, check all system connections for leak tightness and tighten if necessary.
- Only pressurise systems slowly.
- Avoid pressure blows and high differential pressures.
- Compensate any vibrations occurring in the pipe network by using vibration dampers.

2.5.4 Electric voltage

Contact with live components may result in serious personal injuries or death.

To ensure the safe handling of live components, observe the following points:

- Only connect the product and the accessories to the voltage supply if they are undamaged.
- Comply with all regionally applicable regulations and requirements during installation.
- Provide a circuit breaker in the power supply within easy reach of the product. The circuit breaker disconnects all current-carrying conductors.
- Connect the protective conductor (earth connection) according to regulations.
- Only operate the product and accessories with the cover complete and closed or the electronics housing closed.
- Before starting work on the product:
 1. Disconnect
 - Disconnect the product from all poles and all sides
 2. Secure against restarting
 3. Determine the absence of voltage at all poles
 - With suitable and permissible measuring device (e.g. two-pole voltage tester)
 4. Earth and short circuit

2.5.5 Transport and storage

Inappropriate transport or storage may result in personal injury or damage to property.

For the safe transport and storage of the product and accessories, observe the following:

- Use personal protective equipment during all work with packaging material.
- Handle packaging, the product and accessories carefully.
- Transport and handle the packaged product and accessories according to the markings on the packaging (note lifting gear attachment points, the centre of gravity and alignment e.g. keep vertical, do not throw etc.).
- Only use proper means of transport and lifting equipment that is in proper working order.
- Always adhere to the permissible transport and storage parameters.
- Store the product and accessories only outside of areas exposed to direct sunlight and heat sources.

2.5.6 Installation

Inappropriate assembly or electrical installation of the product and accessories may result in personal injury and damage to property as well as impair operation.

For safe assembly and electrical installation, observe the following points:

- Install the product, the accessories, and all parts and materials used so that they are not subject to mechanical tension.
- Check all plug-type connections for a correct fit.
- Avoid a stumbling hazard by routing cables and hoses accordingly.
- Avoid mechanical strain on the cables.
- Fix and fasten hoses in such a way that they cannot flap around.
- Install the inlet lines and drain lines as fixed pipes.

2.5.7 Maintenance

Inappropriate completion of maintenance and repair work may result in serious personal injuries or death.

For safe maintenance and repair, observe the following points:

- Before starting work, depressurise the pressurised product and accessories and secure them against unintentional pressurisation.
- Before starting work, disconnect the product and accessories and secure them against being switched back on again unintentionally.
- Only use materials approved for the respective application.
- Use only suitable tools that are in proper working order.
- Only use cleaned pipes and hoses that are free of dirt and corrosion.
- Never use abrasive or aggressive cleaning agents or solvents which could damage the outer coating (e.g. markings, type plate, corrosion protection, etc.).
- Never clean the device with hard or pointed implements.
- Use only the specified materials and media for cleaning.
- Observe statutory, local and in-house hygiene regulations.
- Pay attention to order and cleanliness during maintenance and repair work. Prevent contamination from entering the opened product or accessories. Store disassembled components and accessories directly in a safe place.
- After completing maintenance and repair work, remove all tools and cleaning agents used, as well as all parts that are no longer needed, from the work area.
- Only dispose of product and accessories when cleaned and freed of any residue.
- Dispose of all components, parts, operating and auxiliary materials as well as cleaning agents professionally and in accordance with all locally applicable regulations and standards.
- Dispose of electrical and electronic components using a specialist disposal company or return them to manufacturer.

2.5.8 Handling hazardous substances

Contact with condensate containing substances which endanger health and the environment can pose a health hazard, causing irritation and/or damage to the eyes, skin and mucous membranes. In addition, polluted condensate must be prevented from entering the sewerage system, waters or the ground.

For the safe handling of polluted condensate the following points must be observed:

- Use suitable protective equipment when handling condensate.
- Pick up and dispose of any leaking or spilled condensate in accordance with applicable regional laws and requirements.

2.5.9 Working on electronic components

Electrostatic discharge (ESD) can cause damage to electronic components, and operational disturbances, device failures or material damage are possible.

- Take proper measures to prevent electrostatic discharge (e.g. earthing, potential equalisation, ESD-compatible dissipative work pads etc.).

2.5.10 Use of spare parts, accessories or materials

The use of incorrect spare parts, accessories or materials, as well as auxiliary and operating materials, may result in death or serious injury. Malfunction and device failure as well as material damage can occur.

- Only use undamaged original parts, auxiliary and operating materials which are specified by the manufacturer to complete all work.
- Only use the materials approved for the respective application and suitable tools in proper working order.
- Only use cleaned pipes that are free of dirt and corrosion.
- Only use electric components and materials that comply with regionally applicable specifications and regulations (standards, directives etc.) for electrical safety.

2.6 Warning notices

Warning notices warn against dangers when handling the product and accessories.

In order to prevent accidents, personal injury and damage to property as well as impairments during operation, it is essential to adhere to the warning notices.

Structural set up:

SIGNAL WORD	Type and source of danger!
 Symbol	Possible consequences if the danger is ignored
	<ul style="list-style-type: none"> • Measures to prevent the danger

Signal words:

DANGER	Imminent hazard Consequences of non-compliance: Death or serious personal injury
WARNING	Imminent hazard Consequences of non-compliance: Death or serious personal injury are possible
CAUTION	Potential hazard Consequences of non-compliance: Personal injury or damage to property are possible
NOTE	Additional notes Consequences of non-compliance: Damage to property, malfunction and device failure are possible. No hazard to people or endangerment of safe operation.

3. Product information

3.1 Product overview

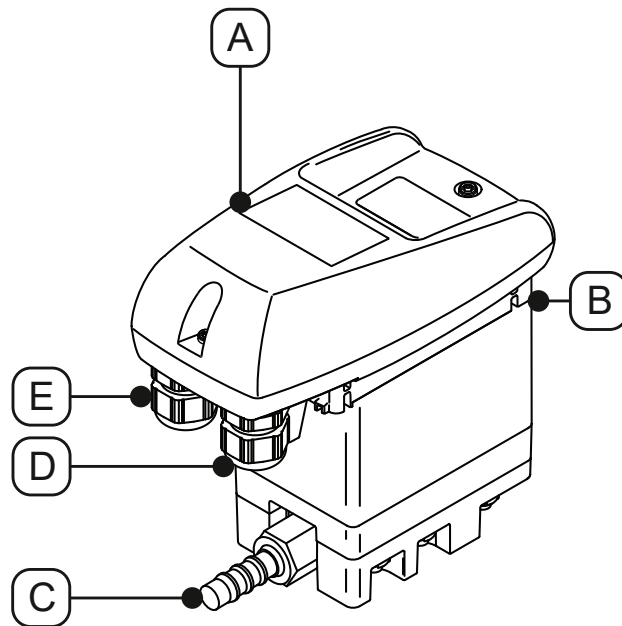

Item	Description / explanation
[A]	Control unit, complete
[B]	Condensate inlet
[C]	Condensate drain

Item	Description / explanation
[D]	Right cable gland
[E]	Left cable gland

3.2 Exploded drawing

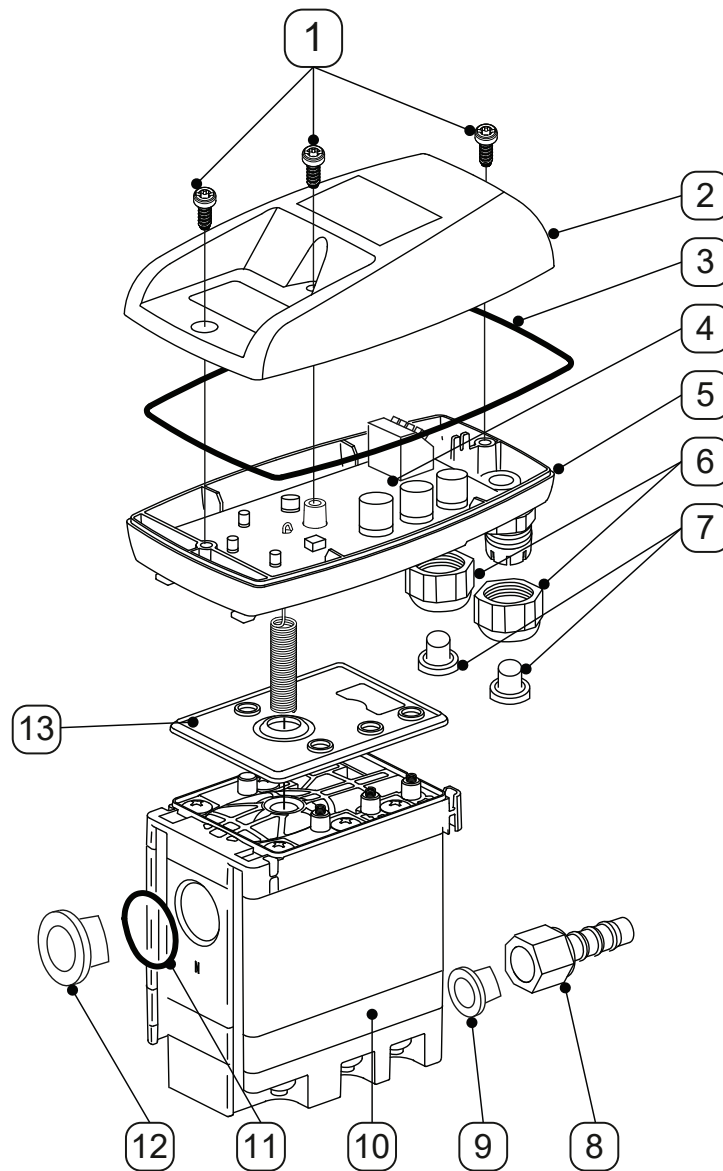

Item	Description / explanation
[1]	Screw 3.5 x 10 mm
[2]	Top cover
[3]	Moulded seal
[4]	Sensor board
[5]	Bottom cover
[6]	Screw fitting
[7]	Plug

Item	Description / explanation
[8]	Hose connection
[9]	Tapered plug
[10]	Service-Unit
[11]	O-ring 20 x 2 mm
[12]	Screw plug G1/2"
[13]	Sealing mat

3.3 Function description

Illustration	Description / explanation
	<p>The condensate flows via the condensate inlet [B] into the BEKOMAT® and collects in the housing [X1].</p> <p>The filling level in the housing [X1] is continuously monitored by a capacitive sensor in the sensor tube [X2].</p>
	<p>Once the condensate has reached the maximum filling level, the pre-set waiting time in the controller is started.</p> <p>During the waiting time, the condensate level in the housing [X1] and the condensate inlet line increases continuously.</p>

Illustration	Description / explanation
	<p>Once the pre-set waiting time has expired, the controller switches the pilot valve [X3].</p> <p>The area above the membrane [X4] is depressurised.</p> <p>The membrane [X4] lifts off the valve seat and the excess pressure in the housing [X1] forces the condensate into the condensate drain [C].</p>
	<p>When the sensor in the sensor tube [X2] is no longer covered by condensate, the controller switches the pilot valve [X3] and pressure builds up above the membrane [X4].</p> <p>The membrane [X4] is pressed against the valve seat and the condensate drain [D] is sealed and closed off.</p>

3.4 Type plate

The type plate, which contains identification information and operating parameters for the product, is located on the bottom cover.



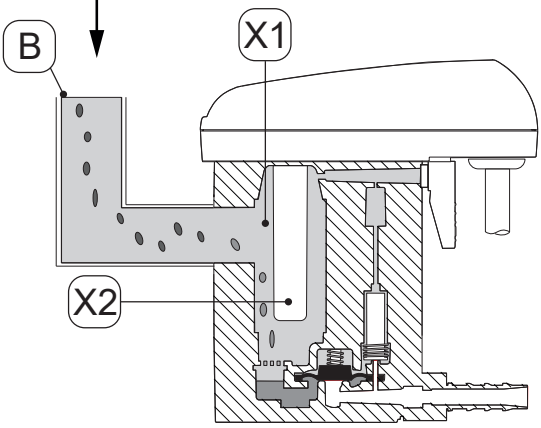
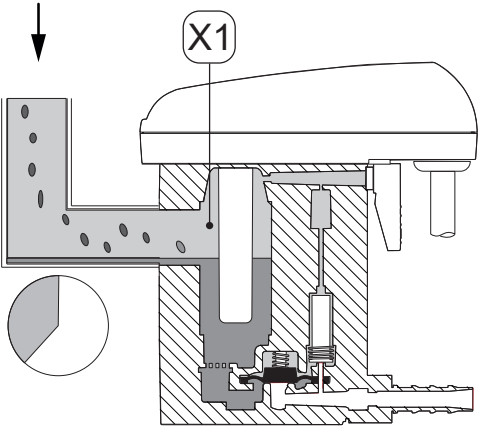
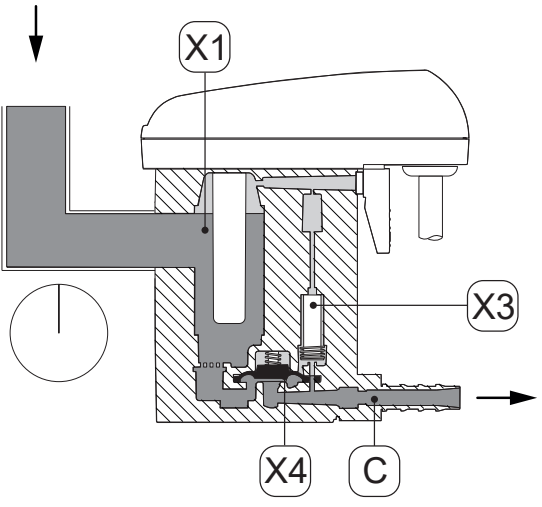
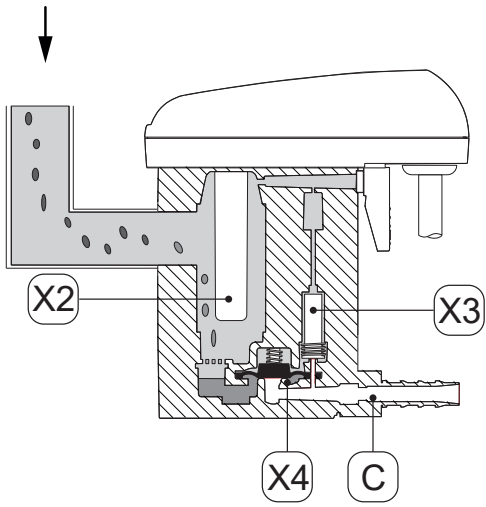
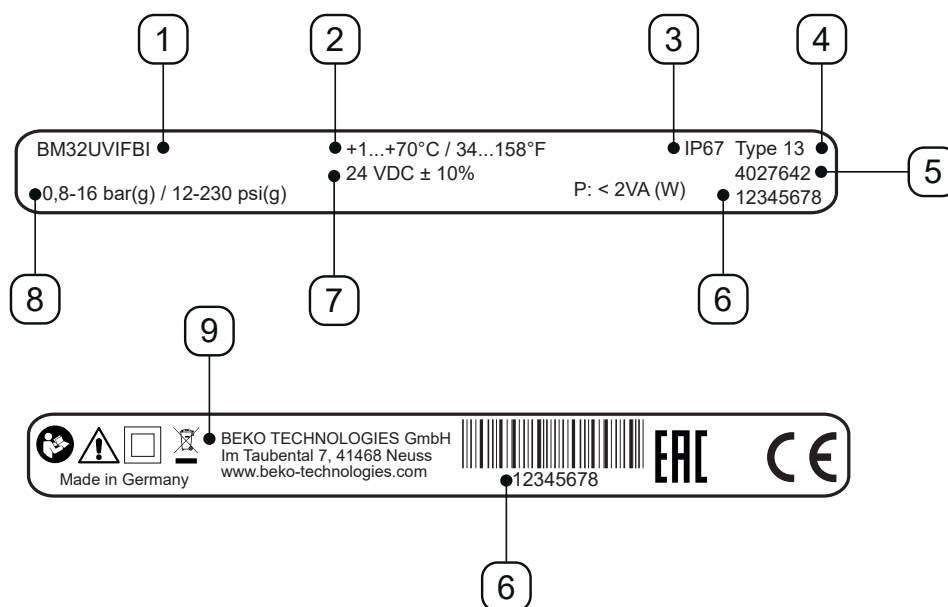

Example illustration

Item	Description / explanation
[1]	Product name
[2]	Operating temperature
[3]	IP degree of protection
[4]	Enclosure rating
[5]	Material number
[6]	Serial number
[7]	Operating voltage
[8]	Operating pressure
[9]	Manufacturer

For more information, refer to section “2.4 Explanation of the safety symbols used” on page 8.

3.5 Scope of delivery

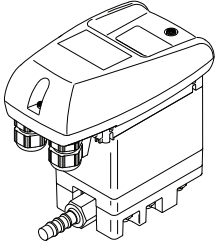
The table below shows the scope of delivery of the product:

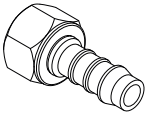
Illustration	Description / explanation
	BEKOMAT® 32U IF Built-in
	Original installation and operation manual
	1 x connector

4. Technical data

4.1 Operating parameters

BEKOMAT®	32U Vario IF Built-in
Relative ambient humidity	10 ... 80 %, without condensation
Maximum operating height	2000 m 2187.23 yd
Minimum / maximum absolute operating pressure	0.8 ... 16 bar(g) 12 ... 230 psi(g)
Minimum / maximum operating temperature	+1 ... 70 °C +34 ... +158 °F
Average discharge rate	54.8 l/h 14.48 gal/h
Maximum discharge rate (short-term)	75 l/h 14.48 gal/h
Connection*, Condensate inlet	1 x G1/2" interior, maximum screw-in depth: 13.5 mm (1/2 in)
Connection, condensate drain	1 x G1/4" external, hose connection for hose diameter 8 ... 10 mm (0.31 ... 0.39 in), internal
Media	Condensate, oil-contaminated or oil-free
Empty weight	0.8 kg 1.76 lbs
Operating voltage	24 VDC ±10% (see type plate)
Power consumption	P <2 VA (W)
Degree of protection	IP67
Enclosure rating	Type 13
Overvoltage category (IEC 61010-1)	II
Degree of pollution (IEC 61010-1)	2
Recommended cable diameter	5 ... 10 mm 0.23 ... 0.33 in
Recommended wire cross-sectional area	0.25 ... 1 mm ² AWG 18 ... 24
Recommended shortening of the cable jacket	~ 50 mm ~ 1.97 in
Recommended stripping length of the cable wires	~ 6 mm ~ 0.24 in

* The NPT thread version is available as an option.

4.2 Storage and transportation parameters

BEKOMAT®	32U Vario IF Built-in
Minimum / maximum temperature, storage and transport	+1 ... +70 °C +34 ... +158 °F

4.3 Materials

BEKOMAT®	32U Vario IF Built-in
Housing	Aluminium and plastic, glass fibre reinforced
Membrane	FKM

4.4 Screw fastening torques

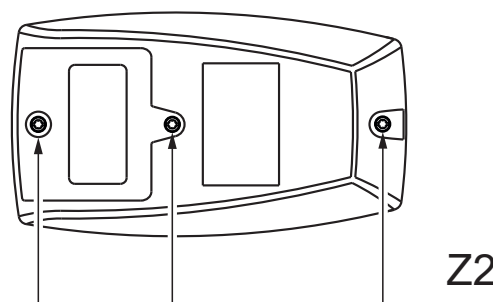
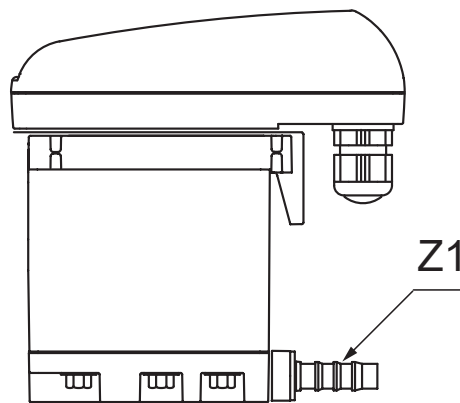

Item	Description / explanation	Tightening torques
[Z1]	Hose connection, condensate drain	3 ... 4 Nm (2.21 ... 2.95 ft-lb)
[Z2]	Screws, top cover	0.9 Nm +0.5 Nm (0.66 ft-lb +0.37 ft-lb)

4.5 Dimensions

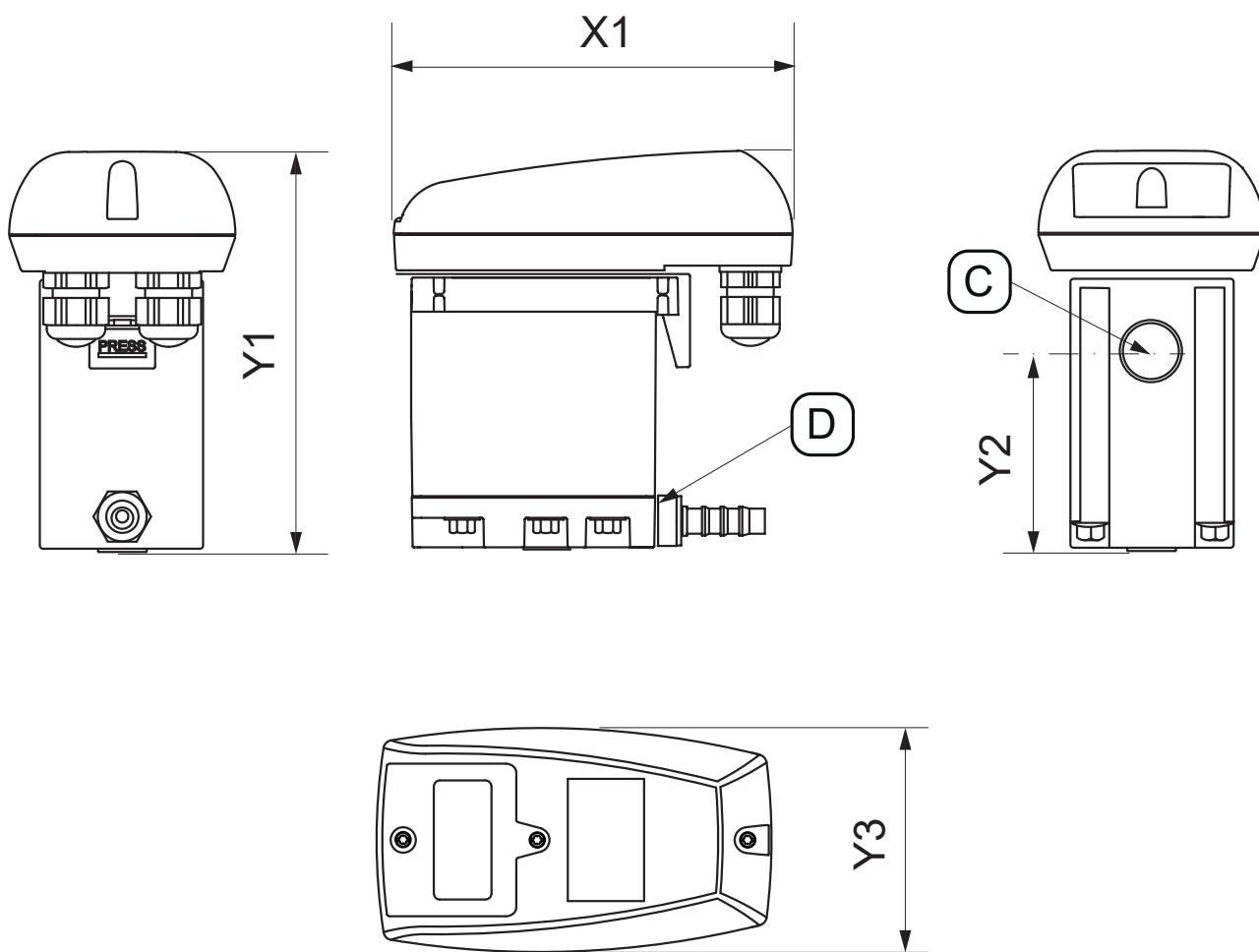

Splitting unit	BEKOMAT® 32U Vario IF Built-in
[X1]	129.5 mm 6.48 in
[Y1]	130 mm 5.12 in
[Y2]	65.5 mm 2.58 in
[Y3]	73.4 mm 2.87 in
[C] - Connection, condensate inlet	G1/2" (NPT 1/2")
[D] - Connection, condensate drain	G1/4" Ø 8-10 (dia 0.32 - 0.39)



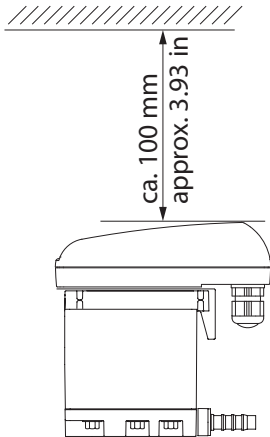

4.6 Installation dimensions

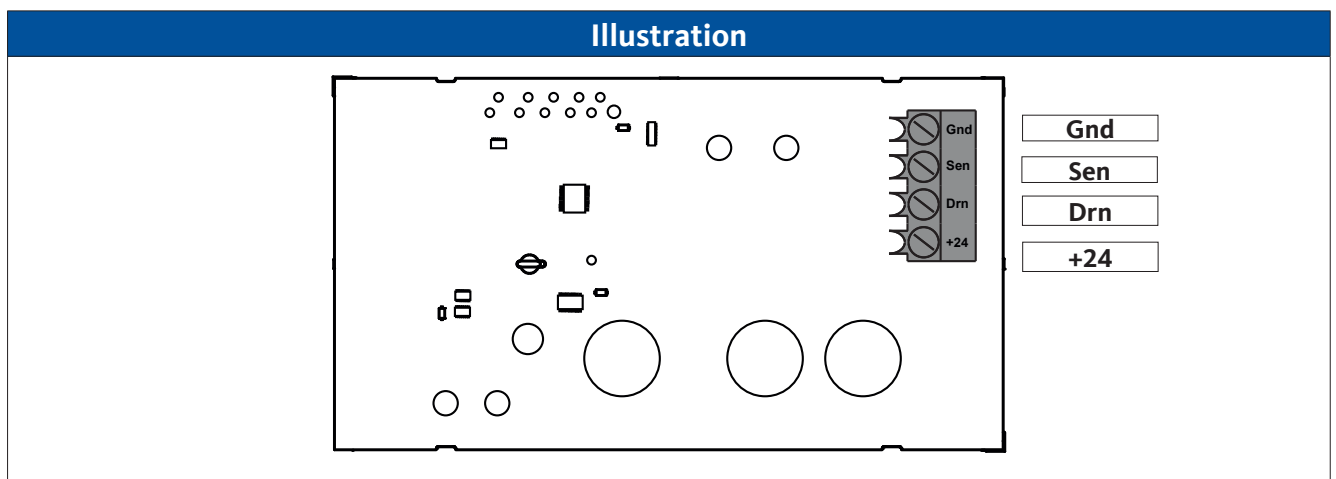
Illustration	Description / explanation
 <p>ca. 100 mm approx. 3.93 in</p>	<p>Allow sufficient assembly space above the top cover at the place of installation so that the LEDs are visible and the TEST button can be pressed.</p>

4.7 Terminal diagram



5. Transport and storage

WARNING	Insufficient qualification!
	<p>Insufficient qualification of the personnel carrying out work on the product and accessories can lead to accidents, personal injury and damage to property as well as impair operation.</p> <ul style="list-style-type: none"> The work on the product and accessories described below may only be executed and documented by skilled personnel - transport and storage.
CAUTION	Inappropriate transport or storage!
 	<p>Inappropriate transport or storage may result in personal injury or damage to the device.</p> <ul style="list-style-type: none"> Use personal protective equipment during all work with packaging material. Handle packaging, the product and accessories carefully. Pack all parts impact-proof using suitable material. Transport and handle the packaging according to the markings (note lifting gear attachment points, the centre of gravity and alignment e.g. keep vertical, do not throw etc.). Only use proper means of transport and lifting equipment that is in proper working order. Always adhere to the permissible transport and storage parameters. Store the product and accessories only outside of areas exposed to direct sunlight and heat sources.
NOTE	Handling packaging material!
	<p>Inappropriate disposal of packaging materials can cause environmental damage.</p> <ul style="list-style-type: none"> Dispose of the packaging material in accordance with the applicable legal requirements and provisions of the country and place of use.

5.1 Transport

After transporting and removing the packaging material, inspect the product for possible transport damage. If you find any damage, notify the carrier company, the manufacturer or one of its agents immediately.

Transport the product as follows:

- Only transport the product in its original packaging.
- Handle packaging and the product with care.
- Note the transport weight specification and marking on the packaging.
- Secure the packaging and the product against slipping and falling during transport.





5.2 Storage

Store the product and the accessories as follows:

- Adhere to the storage parameters in section “4.2 Storage and transportation parameters” on page 21.
- Store in a closed, dry as well as frost-free room.
- Store protected from external influences of the weather, direct sunlight and sources of heat.
- Secure against falling over and protect against vibrations at the storage location.

6. Assembly

6.1 Warning notices

DANGER	Use of incorrect spare parts, accessories or materials!
	<p>The use of incorrect spare parts, accessories or materials, as well as auxiliary and operating materials, may result in death or serious injury. Malfunction and device failure as well as material damage can occur.</p>
	<ul style="list-style-type: none"> • Only use undamaged original parts, auxiliary and operating materials which are specified by the manufacturer to complete all work. • Only use the materials approved for the respective application and suitable tools in proper working order. • Only use pipes that are free of dirt, damage and corrosion.
DANGER	Pressurised system!
	<p>There is a danger of death or serious personal injury resulting from contact with fast or suddenly escaping fluids or through bursting system parts.</p>
	<ul style="list-style-type: none"> • Before starting work, depressurise the pressurised system and secure it against unintentional pressurisation. • Set up a safety area around the working area during assembly, installation, maintenance and repair work. • Assemble all pipes free of mechanical stress. • Install the inlet lines and drain lines as fixed pipes. • Before pressurisation, check all system connections for leak tightness and tighten if necessary. • Slowly pressurise the system. • Avoid pressure blows and high differential pressures.
WARNING	Insufficient qualification!
	<p>Insufficient qualification of the personnel carrying out work on the product and accessories can lead to accidents, personal injury and damage to property as well as impair operation.</p>
	<ul style="list-style-type: none"> • All work on the product and accessories may only be carried out by skilled technical personnel - pressure equipment and plants.
WARNING	Inappropriate assembly!
	<p>Inappropriate assembly of the product and the accessories can lead to personal injury and damage to property as well as impair operation.</p>
	<ul style="list-style-type: none"> • Install the product, the accessories, and all parts and materials used so that they are not subject to mechanical tension. • Fix hoses in such a way that they do not flap around.

6.2 Assembly conditions

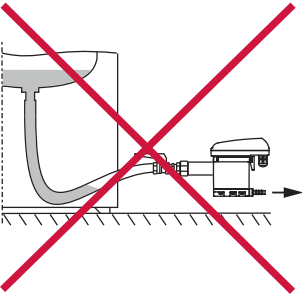
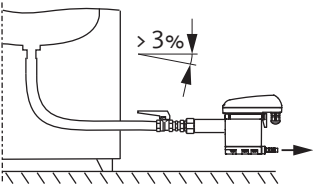
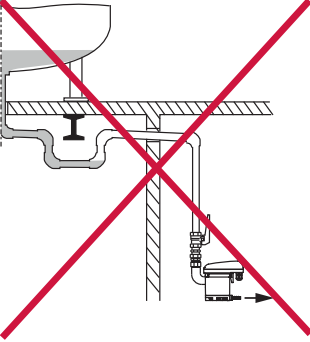
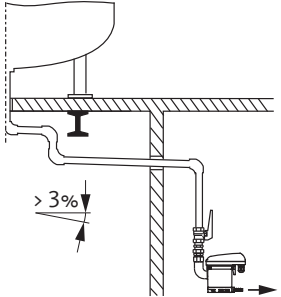
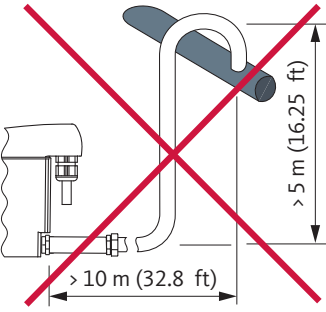
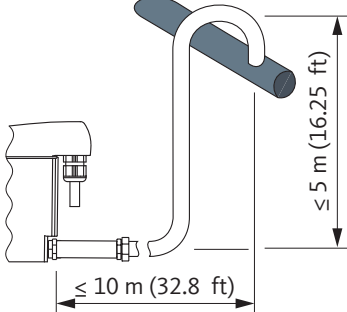
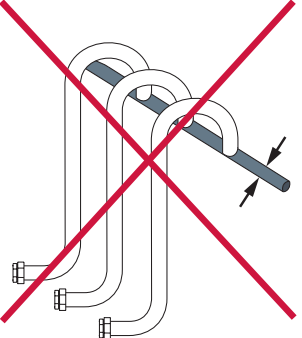
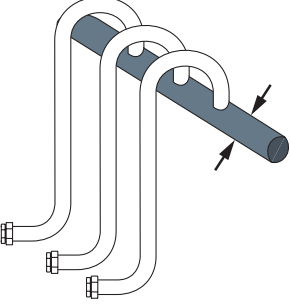
Wrong	Right	Description / explanation
		<p>Continuous slope >3 % in hoses</p> <ul style="list-style-type: none"> When using hoses as the inlet line, ensure a continuous slope >3 %. Make sure that no water pockets form.
		<p>Continuous slope > 3 % in pipes</p> <ul style="list-style-type: none"> When installing the inlet line pipe, ensure a continuous slope >3 %. Make sure that no water pockets form.
		<p>Drain line version</p> <ul style="list-style-type: none"> Do not use shut-off valves in the drain line. Only connect the BEKOMAT® to the drain line using a hose. <ul style="list-style-type: none"> → The hose compensates for assembly tolerances, vibrations and thermal expansion. Do not install the drain line on storage or transportation surfaces. The drain line may be a maximum of 10 m (32.8 ft) long and installed at a maximum of 5 m (16.25 ft) rise. <ul style="list-style-type: none"> → The minimum operating pressure increases by 0.1 bar(g) (1.5 psi(g)) per metre of incline.
		<p>Manifold design</p> <ul style="list-style-type: none"> The cross-section of the manifold must be at least equal to the sum of the individual cross-sections of the connected inlet lines. Route the manifold with a continuous slope >3%.

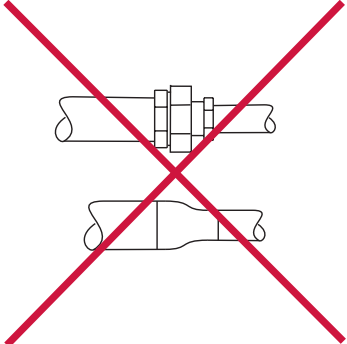
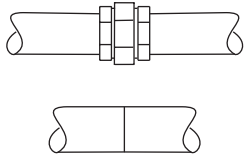
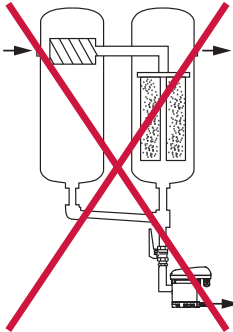
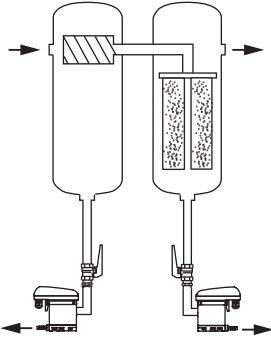
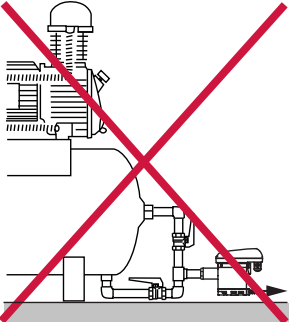
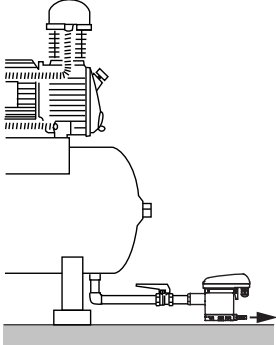
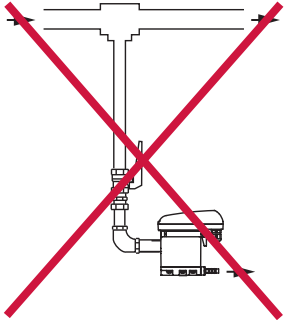
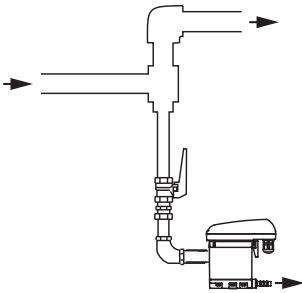
Wrong	Right	Description / explanation
		<p>Maintain the minimum pipe diameter</p> <ul style="list-style-type: none"> • The minimum inside diameter of the inlet line and drain line is 13 mm (0.5 in). • Do not restrict or reduce the (minimum) pipe diameter with reducers (reducing nipple fittings).
		<p>Bypassing filters</p> <ul style="list-style-type: none"> • Discharge each condensate collection point with a separate BEKOMAT®. • Do not create filter bypasses.
		<p>Do not install venting lines</p> <ul style="list-style-type: none"> • Installations requiring a venting line are not permitted with this BEKOMAT® version.
		<p>Discharge from pressurised pipes</p> <ul style="list-style-type: none"> • Divert the flow of gas to provide a deflecting surface to discharge the fluid components in the gas.

6.3 Assembly work

For assembly work to be carried out, the following prerequisites must be fulfilled and the preparatory tasks must have been completed.

Prerequisites		
Tools	Material	Protective equipment
<ul style="list-style-type: none"> Combination wrench or adjustable wrench 	<ul style="list-style-type: none"> Sealants e.g. PTFE Feed line Drain line Hose, interior diameter 8 ... 10 mm (0.31 ... 0.39 in), length approx. 30 cm (1 ft) 	<p>Always to be worn:</p> 



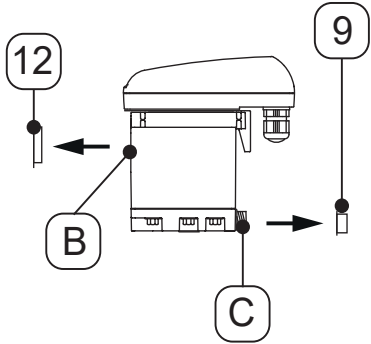
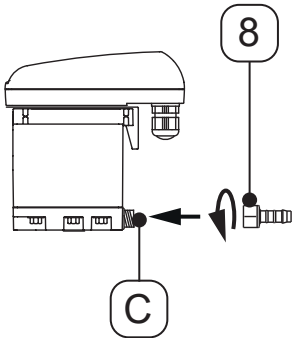

Preparatory tasks	
1.	Depressurise the pressurised system or the respective system section and secure it against unintentional pressurisation.

Assembly work	
Illustration	Description / explanation
	<ol style="list-style-type: none"> Remove the plugs [9, 12] on the condensate inlet [B] and condensate drain [C].
	<ol style="list-style-type: none"> Screw the enclosed hose connection [8] to the condensate drain [C]. Tighten the hose connection [8] with a torque of 3 ... 4 Nm (2.21 ... 2.95 ft-lb).

Assembly work	
Illustration	Description / explanation
<p>The top diagram shows a horizontal pipe with a shut-off valve (X6) being installed on the condensate inlet line (X5). The inlet is labeled B. The bottom diagram shows a vertical pipe with a shut-off valve (X6) being installed on the condensate inlet line (X5). The inlet is labeled B.</p>	<p>Recommendation:</p> <ol style="list-style-type: none"> To ensure easy maintenance of the product, install a shut-off valve [X6] in the condensate inlet line [X5]. For the condensate inlet line [X5], apply sealant to the end of a pressure-resistant pipe and screw this in at condensate inlet [B].
<p>The diagram shows a side view of the unit with a hose (X7) connected to the condensate drain line (X8). A hose clamp (8) is used to secure the connection.</p>	<ol style="list-style-type: none"> For the condensate drain, push the hose provided [X7] onto the hose connection [8] and use a hose clamp for fixation. Connect the other end of the hose [X7] to the condensate drain line [X8].

7. Electrical installation

7.1 Warning notices

DANGER	Use of incorrect spare parts, accessories or materials!
	<p>The use of incorrect spare parts, accessories or materials, as well as auxiliary and operating materials, may result in death or serious injury. Malfunction and device failure as well as material damage can occur.</p> <ul style="list-style-type: none"> • Only use undamaged original parts, auxiliary and operating materials which are specified by the manufacturer to complete all work. • Only use the materials approved for the respective application and suitable tools in proper working order. • Only use electric components and materials that comply with regionally applicable specifications and regulations for electrical safety.
DANGER	Electric voltage!
	<p>There is a danger of death or serious injuries as well as malfunction and device failure following contact with components which are in contact with electric voltage.</p> <ul style="list-style-type: none"> • Only carry out installation, maintenance and repair work on the product and accessories when they have been disconnected and secured against being switched back on again unintentionally. • Set up a safety area around the working area during all installation, maintenance and repair work. • Comply with all regionally applicable regulations and requirements during installation. • Provide a circuit breaker in the power supply within easy reach of the product. The circuit breaker disconnects all current-carrying conductors. • Connect the protective conductor (earth connection) according to regulations.
WARNING	Insufficient qualification!
	<p>Insufficient qualification of the personnel carrying out work on the product and accessories can lead to accidents, personal injury and damage to property as well as impair operation.</p> <ul style="list-style-type: none"> • All work on the product and the accessories may only be carried out by skilled technical personnel - electrical engineering.
CAUTION	Inappropriate electrical installation!
	<p>Inappropriate electrical installation of the product and the accessories can lead to personal injury and damage to property as well as impair operation.</p> <ul style="list-style-type: none"> • Check all plug-type connections for a correct fit. • Avoid stumbling hazard through appropriate cable routing. • Avoid mechanical strain on the cables.
WARNING	Ingress of moisture or foreign bodies!
	<p>Removing components or opening the product may allow water or foreign bodies to enter the opened product. Ingress of water or foreign bodies can lead to accidents, personal injury and damage to property as well as impairments in operation.</p> <ul style="list-style-type: none"> • Protect the product from splashing water or moisture. • Only open the product or remove components in a dry place. • Do not insert any foreign bodies into the openings of the product. • Keep all contact surfaces and openings free of dirt and moisture.

7.2 Connection work

For connection work to be carried out, the following prerequisites must be fulfilled and the preparatory tasks must have been completed.

Prerequisites		
Tools	Material	Protective equipment
<ul style="list-style-type: none"> Stripping tool Crimping tool for wire-end ferrules Screwdriver – flat head size 2.5 mm (0.09 in) Torx screwdriver - T15 	<ul style="list-style-type: none"> 4-wire cable for 24 V voltage supply Wire-end ferrules 	<p>Always to be worn:</p> 

Preparatory tasks	
1.	Assembly is completed.



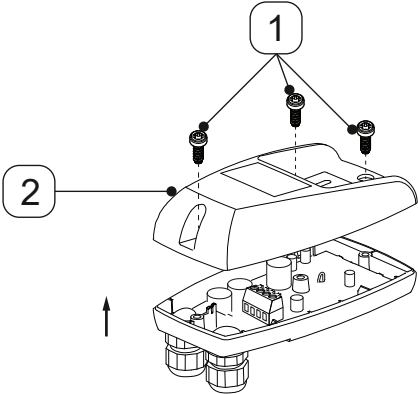
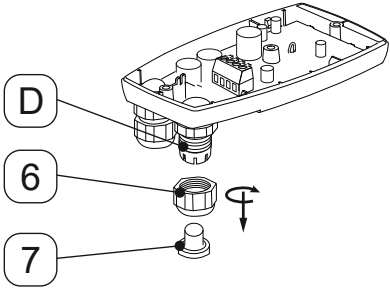
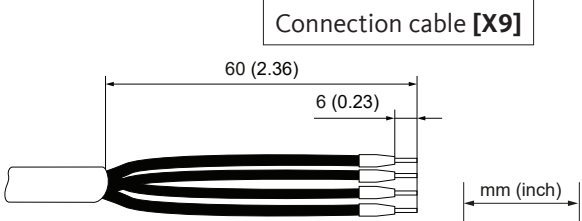

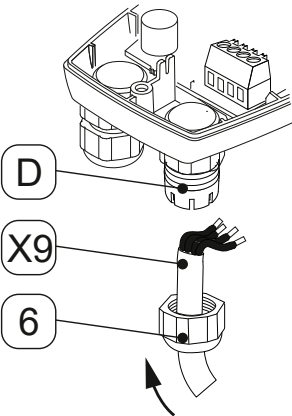
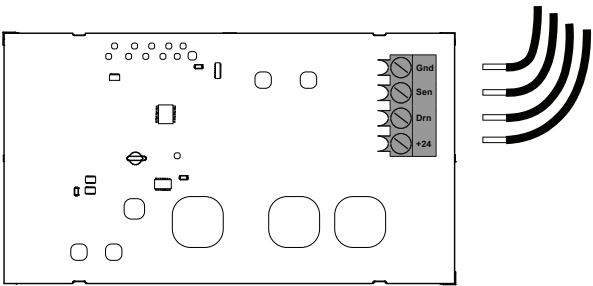
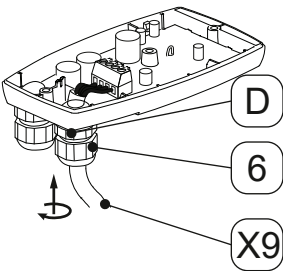
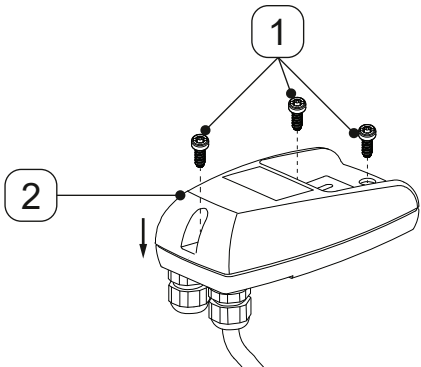
7.2.1 Voltage supply connection

Connection work	
Illustration	Description / explanation
	<ol style="list-style-type: none"> Loosen the 3 screws [1]. Lift the top cover [2].
	<ol style="list-style-type: none"> Unscrew the counter nut [6] from the cable gland [D]. Remove the plugs [7] from the counter nut [6].
	<ol style="list-style-type: none"> Prepare the connection cable [X9].

Connection work	
Illustration	Description / explanation
	<p>6. Fit the counter nut [6] over the connection cable [X9].</p> <p>7. Insert the connection cable [X9] into the cable gland [D].</p>
<p style="text-align: center;">Connection cable [X9]</p> 	<p>8. Connect the connection cable [X9] according to the terminal diagram (see “4.7 Terminal diagram” on page 23).</p>
	<p>9. Draw the connection cable [X9] taut.</p> <p>10. Screw the counter nut [6] onto the cable gland [D].</p>
	<p>11. Set the top cover [2] in place and insert the screws [1].</p> <p>12. Tighten the screws [1] with a torque of 0.9 Nm +0.5 Nm (0.66 ft-lb +0.37 ft-lb).</p>

8. Commissioning

8.1 Warning notices

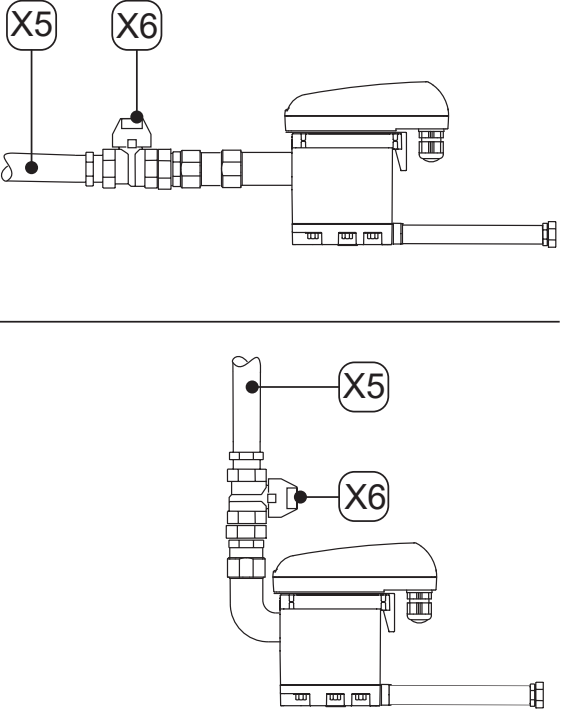

DANGER	Operation outside the permissible limit range!
	<p>Operation of the product and accessories outside the permissible limits and operating parameters, unauthorised intervention and modifications may result in death or serious injury.</p>
	<ul style="list-style-type: none"> • Adhere to the limits and operating parameters specified on the type plate and in the manual. • Check whether the operating parameters have been amended or restricted by the use of accessories.
DANGER	Pressurised system!
	<p>There is a danger of death or serious personal injury resulting from contact with fast or suddenly escaping fluids or through bursting system parts.</p>
	<ul style="list-style-type: none"> • Before pressurisation, check all system connections for leak tightness and tighten if necessary. • Slowly pressurise the system. • Avoid pressure blows and high differential pressures.
DANGER	Electric voltage!
	<p>There is a danger of death or serious injuries as well as malfunction and device failure following contact with components which are in contact with electric voltage.</p>
	<ul style="list-style-type: none"> • Only operate the product and accessories with the cover complete and closed or the electronics housing closed. • Check the product and accessories before commissioning in accordance with the locally applicable legal requirements and regulations.
WARNING	Insufficient qualification!
	<p>Insufficient qualification of the personnel carrying out work on the product and accessories can lead to accidents, personal injury and damage to property as well as impair operation.</p>
	<ul style="list-style-type: none"> • All work on the product and accessories must be carried out exclusively by skilled technical personnel specializing in pressure equipment and plants and skilled technical personnel specializing in electrical equipment.

8.2 Commissioning work

Illustration	Description / explanation
	<ol style="list-style-type: none"><li data-bbox="791 566 1134 600">1. Connect the voltage supply.<li data-bbox="791 645 1406 741">2. Slowly pressurise the system (e.g. by slowly opening the recommended shut-off valve [X6] in the condensate inlet line [X5]).





9. Operation

9.1 Warning notices

DANGER	Operation outside the permissible limit range!
	<p>Operation of the product and accessories outside the permissible limits and operating parameters, unauthorised intervention and modifications may result in death or serious injury.</p>
	<ul style="list-style-type: none"> • Adhere to the limits and operating parameters specified on the type plate and in the manual. • Observe the assembly conditions and the ambient conditions. • Check whether the operating parameters have been amended or restricted by the use of accessories. • Adhere to the maintenance intervals.
DANGER	Electric voltage!
	<p>There is a danger of death or serious injuries as well as malfunction and device failure following contact with components which are in contact with electric voltage.</p>
	<ul style="list-style-type: none"> • Only operate the product with the cover complete and closed or the electronics housing closed.
NOTE	Operating personnel!
	<p>Insufficient knowledge of the product and the accessories can lead to damage to property and the environment as well as impair operation.</p>
	<ul style="list-style-type: none"> • The product and accessories may only be operated and used by qualified operating personnel.

10. Maintenance

10.1 Warning notices

DANGER	Pressurised system!
	<p>There is a danger of death or serious personal injury resulting from contact with fast or suddenly escaping fluids or through bursting system parts.</p>
	<ul style="list-style-type: none"> • Before starting work, depressurise the pressurised system and secure it against unintentional pressurisation. • Set up a safety area around the working area during assembly, installation, maintenance and repair work. • Assemble all pipes free of mechanical stress. • Install the inlet lines and drain lines as fixed pipes. • Before pressurisation, check all system connections for leak tightness and tighten if necessary. • Slowly pressurise the system. • Avoid pressure blows and high differential pressures.
DANGER	Electric voltage!
	<p>There is a danger of death or serious injuries as well as malfunction and device failure following contact with components which are in contact with electric voltage.</p>
	<ul style="list-style-type: none"> • Only carry out maintenance and repair work on the product when it has been disconnected and locked and tagged out. • Set up a safety area around the working area during all maintenance and repair work. • Comply with all regionally applicable regulations and requirements during installation. • Only operate the product with the cover complete and closed or the electronics housing closed.
DANGER	Use of incorrect spare parts, accessories or materials!
	<p>The use of incorrect spare parts, accessories or materials, as well as auxiliary and operating materials, may result in death or serious injury. Malfunction and device failure as well as material damage can occur.</p>
	<ul style="list-style-type: none"> • Only use undamaged original parts, auxiliary and operating materials which are specified by the manufacturer to complete all work. • Use only the approved materials and suitable tools for the respective purpose and make sure that they are in proper working order. • Only use cleaned pipes that are free of dirt and corrosion. • Only use electric components and materials that comply with regionally applicable specifications and regulations (standards, directives etc.) for electrical safety.
WARNING	Insufficient qualification!
	<p>Insufficient qualification of the personnel carrying out work on the product and accessories can lead to accidents, personal injury and damage to property as well as impair operation.</p>
	<ul style="list-style-type: none"> • All work on the product and the accessories may only be carried out by skilled technical personnel - customer service.
WARNING	Ingress of moisture or foreign bodies!
	<p>Removing components or opening the product may allow water or foreign bodies to enter the opened product. Ingress of water or foreign bodies can lead to accidents, personal injury and damage to property as well as impairments in operation.</p>
	<ul style="list-style-type: none"> • Protect the product from splashing water or moisture. • Only open the product or remove components in a dry place. • Do not insert any foreign bodies into the openings of the product. • Keep all contact surfaces and openings free of dirt and moisture.

10.2 Maintenance schedule

Maintenance	Interval
Changing the Service-Unit	After 8760 operating hours or 1 million switching cycles*; at least annually
Cleaning	Annually
Functional test	Monthly
Visual inspection	Weekly
Leakage test	After assembly and maintenance works on the product

* based on 7 bar(g) (101.5 psi(g)) and pH-neutral condensate

10.3 Maintenance work

For maintenance work to be carried out, the following prerequisites must be fulfilled and the preparatory tasks must have been completed.

Prerequisites		
Tools	Material	Protective equipment
<ul style="list-style-type: none"> Screwdriver – flat head size 2.5 mm (0.09 in) Combination wrench or adjustable wrench 	<ul style="list-style-type: none"> Sealants Lubricant for greasing the O-rings Mild cleaning agent Cotton or disposable cloth 	<p>Always to be worn:</p> 

10.3.1 Changing the Service-Unit

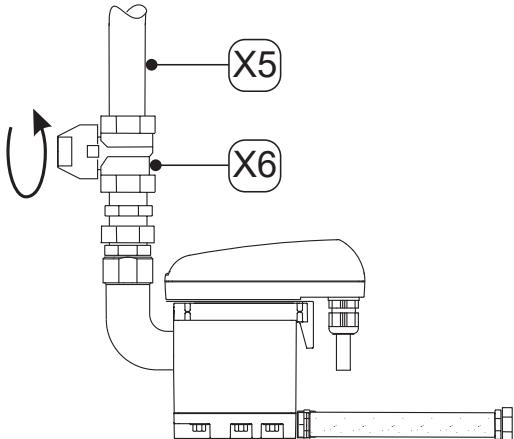
Replacement work	
Illustration	Description / explanation
	<ol style="list-style-type: none"> Interrupt the condensate feed via the condensate inlet line [X5] (e.g. by closing the recommended shut-off valve [X6]).

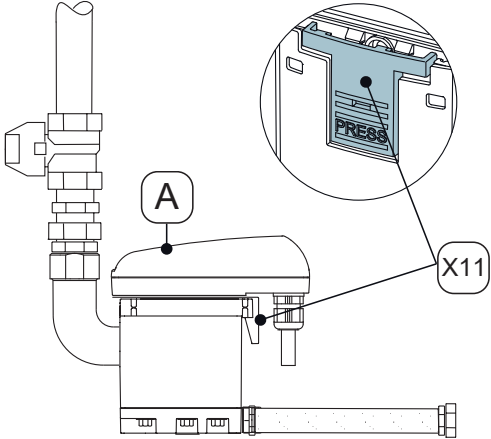
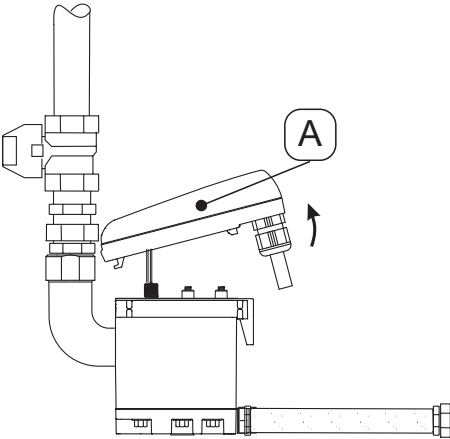
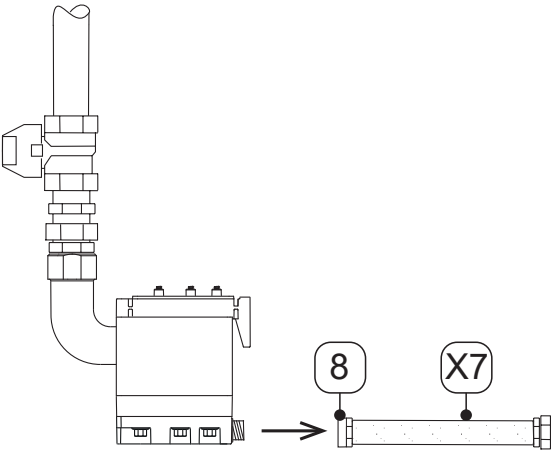
Replacement work	
Illustration	Description / explanation
	<p>2. Release the control unit [A] by pressing the locking hook [X10].</p>
	<p>3. Remove the control unit [A].</p>
	<p>4. Remove the hose connection [8] with the hose [X7].</p>

Replacement work	
Illustration	Description / explanation
	<ol style="list-style-type: none"> 5. Remove the Service-Unit [10] from the pipe on the condensate inlet by undoing the union nut [X11]. 6. Dispose of the old Service-Unit properly (see “14. Disposal” on page 48).
	<ol style="list-style-type: none"> 7. Check to ensure the new Service-Unit [10] fits the control unit [A]: <ul style="list-style-type: none"> → Model designation → The colour of the locking hook [X10] is identical to the colour of the control unit 8. Install pipes between the new Service-Unit [10] and the condensate inlet. 9. Tighten the union nut [X11] firmly.

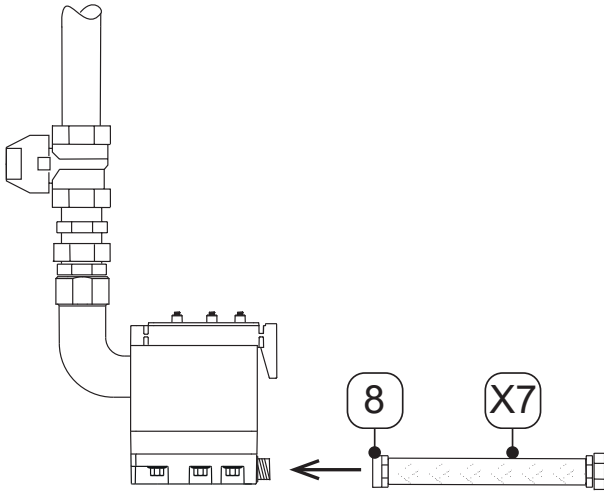
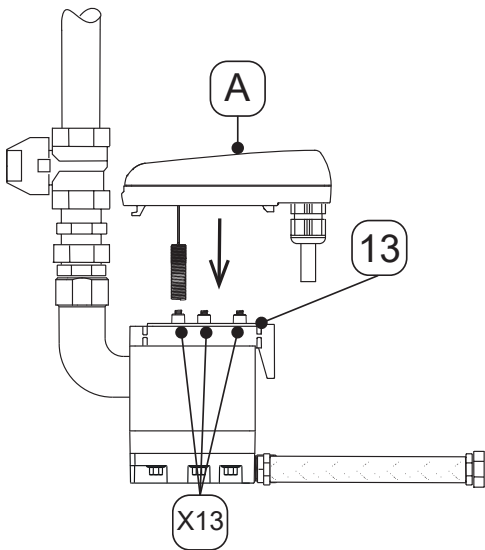
Replacement work	
Illustration	Description / explanation
	<p>10. Fit the hose connection [8] with the hose [X7].</p>
	<p>11. Check to confirm that the sealing mat [13] with contact springs [X12] is clean, dry and free of foreign objects.</p> <p>12. Insert the sensor of the control unit [A] into the sensor tube opening.</p>

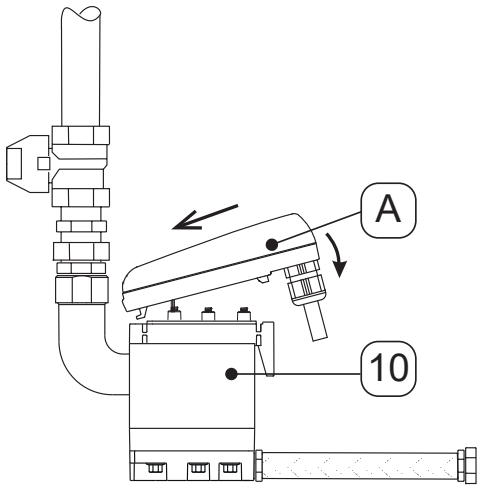
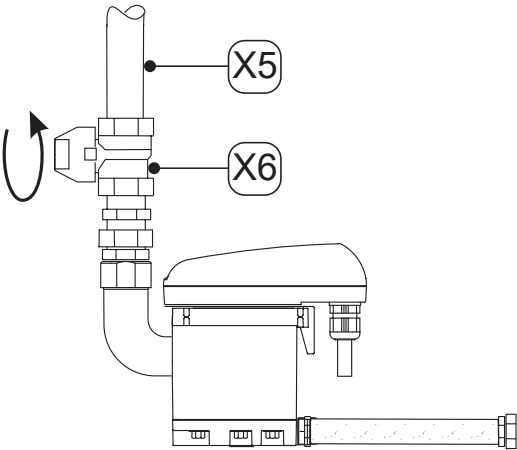
Replacement work	
Illustration	Description / explanation
	<p>13. Insert the hooks on the control unit [A].</p> <p>14. Press the control unit [A] against the Service-Unit [10] and lock into place.</p>
	<p>15. Carry out a leakage test on all screw fittings.</p> <p>16. Carefully open the condensate feed via the condensate inlet lines [X5] (e.g. by opening the recommended shut-off valve [X6]).</p>



10.3.2 Visual inspection

During the visual inspection of the product, inspect all components for mechanical damage and corrosion. Replace damaged components immediately.

10.3.3 Leakage test

The leakage test is a non-destructive test method and is used to prove leak tightness in vacuum and overpressure systems. The leakage test can be carried out in different ways. The manufacturer does not recommend any specific method over another. The selection and determination of the test procedure is the responsibility of the company operating the pressurized system and must be carried out in conformity with the applicable standards and guidelines (e.g., DIN EN 1779).

10.3.4 Cleaning

CAUTION	Inappropriate cleaning and use of the wrong cleaning media!
	<p>Inappropriate cleaning and the use of the wrong cleaning media may result in minor injuries as well as damage to health and damage to property.</p> <ul style="list-style-type: none"> • Never clean the device with a dripping wet cloth. • Never use abrasive or aggressive cleaning agent or solvents which could damage the outer coating (e.g. markings, type plate, corrosion protection, etc.). • Never clean the device with hard or pointed implements. • Use an anti-static, damp cloth for cleaning the outside. • Immediately replace any product markings (pictograms, markings) that have become illegible.
NOTE	Local hygiene regulations!
	In addition to the cleaning instructions listed, any regionally applicable hygiene regulations must be observed.

Preparatory tasks

1.	Decommissioning has been completed.
----	-------------------------------------

Cleaning work

1.	Spray mild cleaning agent onto a cotton cloth or disposable tissue until it is damp (not wet).
2.	Rub the surfaces of the product with the damp cloth.
3.	Begin operation of the product.

11. Consumables, accessories and spare parts

11.1 Order information

Manufacturer customer service requires the following data for an enquiry or order:

- Serial number (see type plate)
- Material number and designation of the accessory or spare part
- Required quantity of accessories or spare parts to be delivered

The contact data for the relevant manufacturer customer services are listed in section “1.1 Contact” on page 4.

11.2 Accessories

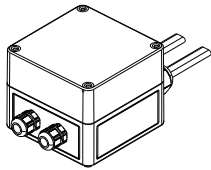
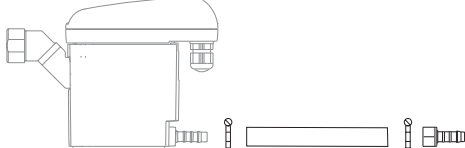

Illustration	Description / explanation	Material no.
	Trace heater 230 VAC	4041657
	Drain kit	2000045

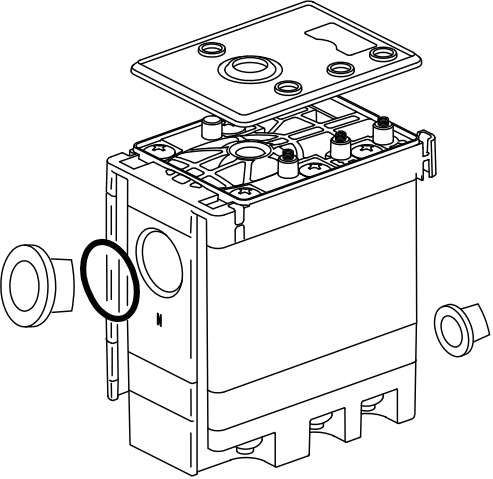
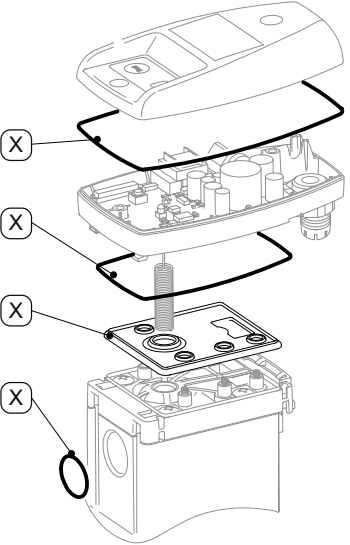
11.3 Spare parts

Illustration	Description / explanation	Material no.
	<p>Service-Unit BEKOMAT® 32U Vario IF</p>	<p>4023573</p>
	<p>Set of seals (contains the marked components [X])</p>	<p>4024392</p>

12. Decommissioning

12.1 Warning notices

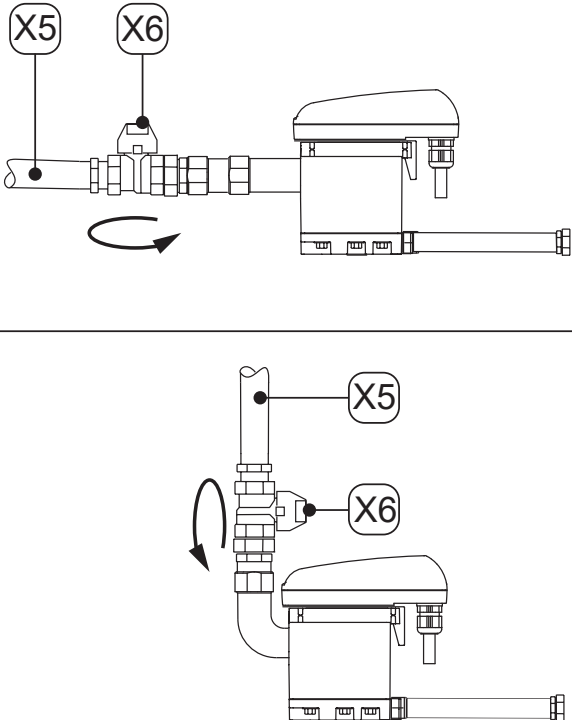

DANGER	Pressurised system!
	<p>There is a danger of death or serious personal injury resulting from contact with fast or suddenly escaping fluids or through bursting system parts.</p> <ul style="list-style-type: none"> • Set up a safety area around the working area before starting work. • Before starting work, depressurise the pressurised system and secure it against unintentional pressurisation.
DANGER	Electric voltage!
	<p>There is a danger of death or serious injuries as well as malfunction and device failure following contact with components which are in contact with electric voltage.</p> <ul style="list-style-type: none"> • Set up a safety area around the working area before starting work. • Before starting work, disconnect the product and accessories and secure them against being switched back on again unintentionally.
WARNING	Insufficient qualification!
	<p>Insufficient qualification of the personnel carrying out work on the product and accessories can lead to accidents, personal injury and damage to property as well as impair operation.</p> <ul style="list-style-type: none"> • All work on the product and the accessories may only be carried out by skilled technical personnel - customer service.

12.2 Decommissioning work

Illustration	Description / explanation
	<ol style="list-style-type: none"> 1. Interrupt the condensate feed via the condensate inlet line [X5] (e.g. by closing the recommended shut-off valve [X6]).



13. Disassembly

13.1 Warning notices

DANGER	Pressurised system!
	<p>There is a danger of death or serious personal injury resulting from contact with fast or suddenly escaping fluids or through bursting system parts.</p> <ul style="list-style-type: none"> • Set up a safety area around the working area before starting work. • Before starting work, depressurise the pressurised system and secure it against unintentional pressurisation.
DANGER	Electric voltage!
	<p>There is a danger of death or serious injuries as well as malfunction and device failure following contact with components which are in contact with electric voltage.</p> <ul style="list-style-type: none"> • Set up a safety area around the working area before starting work. • Before starting work, disconnect the product and accessories and secure them against being switched back on again unintentionally.
WARNING	Insufficient qualification!
	<p>Insufficient qualification of the personnel carrying out work on the product and accessories can lead to accidents, personal injury and damage to property as well as impair operation.</p> <ul style="list-style-type: none"> • All work on the product and the accessories may only be carried out by skilled technical personnel - customer service.

13.2 Disassembly work

For disassembly work to be carried out, the following prerequisites must be fulfilled and the preparatory tasks must have been completed.

Prerequisites		
Tools	Material	Protective equipment
<ul style="list-style-type: none"> • Combination wrench or adjustable wrench 	<ul style="list-style-type: none"> • No material necessary 	<p>Always to be worn:</p> <div style="display: flex; justify-content: space-around; align-items: center;">    </div>

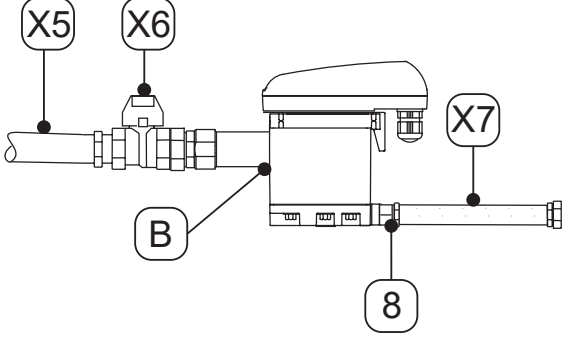
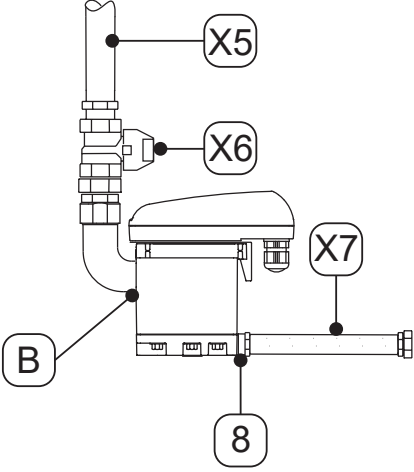

Preparatory tasks	
1.	Decommissioning has been completed.
2.	Depressurise the pressurised system or the respective system section and secure it against unintentional pressurisation.

Disassembly work	
Illustration	Description / explanation
	1. Remove the hose [X7] from the hose connection [8] and disassemble.
	2. Remove the condensate inlet line [X5] and the recommended shut-off valve [X6] from the condensate inlet [B] and disassemble. 3. Disassemble all power supplies.

14. Disposal

At the end of their useful life the product and the accessories must be sent for disposal e.g. by a specialist company. Materials such as glass, plastics and some chemical compounds are mostly recoverable, reusable or recyclable.

14.1 Warning notices

NOTE	Inappropriate disposal!
	<p>Inappropriate disposal of parts, components, operating and auxiliary materials as well as cleaning media can cause environmental damage.</p> <ul style="list-style-type: none"> • Dispose of all components, parts, operating and auxiliary materials as well as cleaning media professionally and in accordance with all locally applicable regulations and standards. • Dispose of electrical and electronic components using a specialist disposal company or return them to manufacturer. • In case of doubt, consult a local disposal company before disposal.
INFORMATION	Disposal of electrical and electronic equipment
	<p>Electrical and electronic equipment (EEE) contains materials, components and substances which can be dangerous and harmful to human health and the environment if the waste from electrical and electronic equipment (WEEE) is not disposed of properly.</p> <p>Electrical and electronic equipment are marked by the crossed out rubbish bin. The crossed-out rubbish bin symbolises that electrical and electronic equipment must be collected separately and must not be disposed of together with unsorted household waste.</p> <p>For additional information regarding locally applicable laws and regulations concerning recycling electrical and electronic products, contact your local disposal companies or the responsible municipal authority.</p>

14.2 Disposal of operating and auxiliary materials

Operating material / auxiliary material	EU waste code
Adsorption materials, filter materials, cleaning wipes and protective clothing - contaminated by oils or other hazardous substances	15 02 02
Adsorption materials, filter materials, cleaning wipes and protective clothing - with the exception of those classified by 15 02 02	15 02 03
Packaging - paper and cardboard	15 01 01
Packaging - plastic material	15 01 02
Waste oil - mineral	13 02 05
Waste oil - synthetic	13 02 06

14.3 Disposal of components

Ensure the following prerequisites are met before disposal:

Prerequisites	
1.	The product and the accessories have been decommissioned and disassembled.
2.	The product and the accessories have been cleaned and any fluid residue has been removed from them.







Components	EU waste code
Electric and electronic devices with the exception of those covered by 20 01 21, 20 01 23 and 20 01 35	20 01 36
Plastic material	20 01 39
Metals	20 01 40

15. Troubleshooting

Error or fault pattern	Possible causes	Troubleshooting
<p>no function detectable</p>	<ul style="list-style-type: none"> • Fault in voltage supply • Sensor board defective • External control defective 	<ul style="list-style-type: none"> • Read off the operating voltage on the type plate and check it • Check whether voltage is present at the terminals of the sensor board • Check the plug connections of the terminal on the sensor board • Replace the sensor board
<p>Input signal "Drn" is "low", but no condensate drain</p>	<ul style="list-style-type: none"> • Feed and/or drain line blocked or closed • Wear • Sensor board defective • Service-Unit defective • Pressure below minimum pressure • Maximum pressure exceeded 	<ul style="list-style-type: none"> • Check the inlet line and the drain lines • Check the plug connections of the terminal on the sensor board • Replace the sensor board • Check the operating pressure
<p>no sensor signal "Sen" (transistor through-connected, Gnd potential) with covered sensor</p>	<ul style="list-style-type: none"> • Inlet line without sufficient slope • Cross-section too small • Excessively high condensate volume (surge) • Sensor board defective 	<ul style="list-style-type: none"> • Install feed line at a slope >3 % • Install a venting line • Check whether the necessary minimum pressure has been reached (see "4. Technical data" on page 20). • Replace the sensor board • Replace the Service-Unit
<p>Sensor signal "Sen" (transistor open) with empty device</p>	<ul style="list-style-type: none"> • Dirty sensor • Wire break at the sensor • Sensor board defective 	<ul style="list-style-type: none"> • Disconnect the product from the operating voltage and reconnect after > 5 seconds • Inspect the sensor board for potential damage • Replace the Service-Unit
<p>The BEKOMAT® discharges continuously.</p>	<ul style="list-style-type: none"> • Service-Unit defective or dirty 	<ul style="list-style-type: none"> • Replace the Service-Unit

16. Appendices

16.1 Approval certificates and declarations of conformity

Symbol	Description / explanation
	<p>CE marking</p> <p>The CE marking indicates that a product fulfils all the EU regulations applicable to the product and that all basic safety and health requirements were met during its production. The product may be sold on the European market.</p>
	<p>FCC marking</p> <p>The FCC marking indicates that a product fulfils the requirements of the Federal Communications Commission (FCC) and that all basic safety and health requirements were met during its production. The product may be sold on the US market.</p>
	<p>cTÜVus marking</p> <p>The cTÜVus marking indicates that a product fulfils the requirements of TÜV Rhineland for the Canadian and US markets and that all basic safety and health requirements were met during its production. The product may be sold on the Canadian and US markets.</p>
	<p>EAC marking</p> <p>The EAC marking indicates that a product fulfils all Eurasian Customs Union regulations applicable to the product and that all basic safety and health requirements were met during its production. The product may be sold on the Eurasian Customs Union market.</p>
	<p>WEEE marking</p> <p>The crossed out rubbish bin marks an electrical or electronic product that must not be disposed of with domestic waste at the end of its service life. Free collecting points for used electrical equipment as well as further acceptance points for reuse of the products are available for them to be returned. Addresses can be obtained from the local authorities.</p>
	<p>UKCA marking</p> <p>UK Conformity Assessed (UKCA) marking is a conformity mark that indicates conformity with the applicable requirements for products sold within Great Britain.</p>

16.2 Declaration of Conformity

BEKO TECHNOLOGIES GMBH
Im Taubental 7
41468 Neuss

GERMANY

Tel: +49 2131 988-0
www.beko-technologies.com



EU-Konformitätserklärung

Wir erklären hiermit, dass das nachfolgend bezeichnete Produkt den Anforderungen der einschlägigen Richtlinien und technischen Normen entspricht. Diese Erklärung bezieht sich nur auf das Produkt in dem Zustand, in dem das Produkt von uns in Verkehr gebracht wurde. Nicht vom Hersteller angebrachte Teile und/oder nachträglich vorgenommene Eingriffe bleiben unberücksichtigt.

Produktbezeichnung:	Kondensatableiter
Modelle:	BEKOMAT® 31UIF, 32UIF, 32UVIF, 33UIF
Spannungsvarianten:	24 VDC ± 10 %
Max. Betriebsdruck:	16 bar(ü)
Produktbeschreibung und Funktion:	Kondensatableiter zur elektronisch niveaugeregelten Ableitung von Kondensat im Kältetrockner.

EMV-Richtlinie 2014/30/EU

Angewandte harmonisierte Normen: EN 61326-1:2013

ROHS II-Richtlinie 2011/65/EU

Die Vorschriften der Richtlinie 2011/65/EU zur Beschränkung der Verwendung bestimmter gefährlicher Stoffe in Elektro- und Elektronikgeräten werden erfüllt.

Der Hersteller trägt die alleinige Verantwortung für die Ausstellung dieser Konformitätserklärung.

Neuss, 21.02.2022

Unterschiedet für und im Namen von:

BEKO TECHNOLOGIES GMBH

i.V. Christian Riedel
Leiter Qualitätsmanagement International

BEKO TECHNOLOGIES GMBH
Im Taubental 7
41468 Neuss

GERMANY

Phone: +49 2131 988-0
www.beko-technologies.com



EU Declaration of Conformity

We hereby declare that the product named below complies with the stipulations of the relevant directives and technical standards. This declaration only refers to the product in the condition in which it has been placed into circulation by us. Parts which have not been installed by the manufacturer and/or modifications which have been implemented subsequently remain unconsidered.

Product designation:	Condensate drain
Models:	BEKOMAT® 31UIF, 32UIF, 32UVIF, 33UIF
Supply voltage versions:	24 VDC \pm 10 %
Max. operating pressure:	16 bar(g)
Product description and function:	Condensate drain for electronically level-controlled discharge of condensate in the refrigeration dryer.

EMC Directive 2014/30/EU

Applied harmonised standards: EN 61326-1:2013

RoHS II Directive 2011/65/EU

The products meet the requirements laid down in European Directive 2011/65/EU concerning the restriction on the use of certain hazardous substances in electrical and electronic devices.

The manufacturer shall have sole responsibility for issuing this declaration of conformity.

Signed for and on behalf of:

Neuss, 21 February 2022

BEKO TECHNOLOGIES GmbH

i.V. Christian Riedel
Head of International Quality Management

BEKO TECHNOLOGIES GMBH
Im Taubental 7
41468 Neuss

GERMANY

Phone: +49 2131 988-0
www.beko-technologies.com



UK Declaration of Conformity

We hereby declare that the product named below complies with the stipulations of the relevant directives and technical standards. This declaration applies only to the product in the condition in which it is marketed by us. Parts which have not been installed by the manufacturer and/or modifications which have been implemented subsequently remain unconsidered.

Product designation:	Condensate drain
Types:	BEKOMAT® 31UIF, 32UIF, 32UVIF, 33UIF
Supply voltage versions:	24 VDC ±10 %
Max. operating pressure:	16 bar(g)
Product description and function:	Condensate drain off for the electronically level-controlled discharge of condensate in the refrigeration dryer.

Manufacturer:	BEKO TECHNOLOGIES GMBH Im Taubental 7, 41468 Neuss, Germany
----------------------	---

Person authorised to compile the technical documentation:	BEKO TECHNOLOGIES Ltd Unit 11-12 Moons Park, Burnt Meadow Road, North Moons Moat Redditch, Worcs, B98 9PA, United Kingdom
--	--

Electromagnetic Compatibility Regulations 2016, 2016 No. 1091
Applied designated standards and further standards: EN 61326-1:2013

RoHS Regulations 2012 No. 3032 (2011/65/EU)
The products meet the requirements laid down in RoHS Regulations 2012 concerning the restriction of the use of certain hazardous substances in electrical and electronic devices.

The products bear the UKCA mark:



BEKO TECHNOLOGIES GMBH shall have sole responsibility for issuing this Declaration of Conformity.

Signed for and on behalf of:

Neuss, 23.08.2022

BEKO TECHNOLOGIES GMBH

i.V. Christian Riedel
Head of Quality Management International

BEKO TECHNOLOGIES GmbH

Im Taubental 7
D - 41468 Neuss
Tel. +49 2131 988 0
Fax +49 2131 988 900
info@beko-technologies.com
service-eu@beko-technologies.com

DE**BEKO TECHNOLOGIES LTD.**

Unit 11-12 Moons Park
Burnt Meadow Road
North Moons Moat
Redditch, Worcs, B98 9PA
Tel. +44 1527 575 778
info@beko-technologies.co.uk

GB**BEKO TECHNOLOGIES S.à.r.l.**

Zone Industrielle
1 Rue des Frères Rémy
F - 57200 Sarreguemines
Tél. +33 387 283 800
info@beko-technologies.fr
service@beko-technologies.fr

FR**BEKO TECHNOLOGIES B.V.**

Veenen 12
NL - 4703 RB Roosendaal
Tel. +31 165 320 300
benelux@beko-technologies.com
service-bnl@beko-technologies.com

NL**BEKO TECHNOLOGIES
(Shanghai) Co. Ltd.**

Rm.715 Building C, VANTONE Center
No.333 Suhong Rd.Minhang District
201106 Shanghai
Tel. +86 (21) 50815885
info.cn@beko-technologies.cn
service1@beko.cn

CN**BEKO TECHNOLOGIES s.r.o.**

Na Pankraci 58
CZ - 140 00 Praha 4
Tel. +420 24 14 14 717 /
+420 24 14 09 333
info@beko-technologies.cz

CZ**BEKO Tecnológica España S.L.**

Torruella i Urpina 37-42, nave 6
E - 08758 Cervelló
Tel. +34 93 632 76 68
Mobil +34 610 780 639
info.es@beko-technologies.es

ES**BEKO TECHNOLOGIES LIMITED**

Room 2608B, Skyline Tower,
No. 39 Wang Kwong Road
Kwoloon Bay Kwoloon, Hong Kong
Tel. +852 2321 0192
Raymond.Low@beko-technologies.com

HK**BEKO TECHNOLOGIES INDIA Pvt. Ltd.**

Plot No.43/1 CIEEP Gandhi Nagar
Balanagar Hyderabad
IN - 500 037
Tel. +91 40 23080275 /
+91 40 23081107
Madhusudan.Masur@bekoindia.com
service@bekoindia.com

IN**BEKO TECHNOLOGIES S.r.l**

Via Peano 86/88
I - 10040 Leini (TO)
Tel. +39 011 4500 576
Fax +39 0114 500 578
info.it@beko-technologies.com
service.it@beko-technologies.com

IT**BEKO TECHNOLOGIES K.K**

KEIHIN THINK Building 8 Floor
1-1 Minamiwatarida-machi
Kawasaki-ku, Kawasaki-shi
JP - 210-0855
Tel. +81 44 328 76 01
info@beko-technologies.jp

JP**BEKO TECHNOLOGIES Sp. z o.o.**

ul. Pańska 73
PL - 00-834 Warszawa
Tel. +48 22 314 75 40
info.pl@beko-technologies.pl

PL**BEKO TECHNOLOGIES S. de R.L. de C.**

BEKO Technologies, S de R.L. de C.V.
Blvd. Vito Alessio Robles 4602 Bodega 10
Zona Industrial
Saltillo, Coahuila, 25107
Mexico
Tel. +52(844) 218-1979
informacion@beko-technologies.com

MX**BEKO TECHNOLOGIES CORP.**

900 Great Southwest Pkwy SW
US - Atlanta, GA 30336
Tel. +1 404 924-6900
Fax +1 (404) 629-6666
beko@bekousa.com

US