



Original installation and operation manual

BEKOMAT® 32U Built-in

> BM32UBI

■ Table of contents

| | |
|--|-----------|
| 1. Notes about the documentation | 5 |
| 1.1 Contact | 5 |
| 1.2 Information about this installation and operation manual | 5 |
| 2. Safety | 6 |
| 2.1 Use | 6 |
| 2.1.1 Intended use | 6 |
| 2.1.2 Reasonably foreseeable inappropriate use | 7 |
| 2.2 Responsibility of the operating company | 7 |
| 2.3 Target group and personnel | 8 |
| 2.4 Explanation of the symbols used | 9 |
| 2.5 Safety instructions and warning notices | 10 |
| 2.5.1 Basic safety instructions | 10 |
| 2.5.2 Safe operation | 10 |
| 2.5.3 Sudden escape of pressurised fluids | 11 |
| 2.5.4 Electric voltage | 11 |
| 2.5.5 Transport and storage | 12 |
| 2.5.6 Installation | 12 |
| 2.5.7 Maintenance | 13 |
| 2.5.8 Handling hazardous substances | 13 |
| 2.5.9 Working on electronic components | 14 |
| 2.5.10 Use of spare parts, accessories or materials | 14 |
| 2.6 Warning notices | 14 |
| 3. Product information | 15 |
| 3.1 Product description | 15 |
| 3.2 Type plate | 15 |
| 3.3 Product overview | 16 |
| 3.4 Scope of delivery | 16 |
| 3.5 Exploded drawing | 17 |
| 3.6 Function description | 18 |
| 4. Technical data | 19 |
| 4.1 Operating parameters | 19 |
| 4.2 Storage and transportation parameters | 20 |
| 4.3 Materials | 20 |
| 4.4 Screw fastening torques | 20 |
| 4.5 Dimensions | 21 |
| 4.6 Installation dimensions | 22 |
| 4.7 Terminal diagram | 22 |
| 5. Transport and storage | 23 |
| 5.1 Warning notices | 23 |
| 5.2 Transport | 23 |
| 5.3 Storage | 23 |

| | |
|---|-----------|
| 6. Installation | 24 |
| 6.1 Warning notices | 24 |
| 6.2 Installation requirements | 24 |
| 6.3 Installation work | 26 |
| 7. Electrical installation | 28 |
| 7.1 Warning notices | 28 |
| 7.2 Connection work | 28 |
| 7.2.1 Connecting the power supply | 29 |
| 7.2.2 Connecting the dry contact | 31 |
| 7.2.3 Connecting the external TEST button | 33 |
| 8. Start-up procedure | 35 |
| 8.1 Warning notices | 35 |
| 8.2 Start-up steps | 35 |
| 9. Operation | 36 |
| 9.1 Warning notices | 36 |
| 9.2 Operating states | 36 |
| 10. Maintenance | 39 |
| 10.1 Warning notices | 39 |
| 10.2 Maintenance schedule | 39 |
| 10.3 Maintenance work | 40 |
| 10.3.1 Changing the Service-Unit | 40 |
| 10.3.2 Functional test | 43 |
| 10.3.3 Visual inspection | 43 |
| 10.3.4 Leakage test | 44 |
| 10.3.5 Cleaning | 44 |
| 10.4 Warning notices | 44 |
| 11. Consumables, accessories and spare parts | 45 |
| 11.1 Order information | 45 |
| 11.2 Accessories | 45 |
| 11.3 Spare parts | 45 |
| 12. Shut-down procedure | 46 |
| 12.1 Warning notices | 46 |
| 12.2 Shut-down steps | 47 |
| 13. Dismounting | 48 |
| 13.1 Warning notices | 48 |
| 13.2 Dismounting steps | 48 |
| 14. Disposal | 50 |
| 14.1 Warning notices | 50 |
| 14.2 Disposal of operating and auxiliary materials | 51 |
| 14.3 Disposal of components | 51 |

| | |
|--------------------------|----|
| 15. Troubleshooting..... | 52 |
| 16. Appendices..... | 53 |
| 16.1 Certificates..... | 53 |
| 17. Notes | 54 |

1. Notes about the documentation

This documentation contains all the necessary steps for the use and operation of the product and the accessories.

1.1 Contact

| Manufacturer | Customer service and tools |
|--|--|
| BEKO TECHNOLOGIES GmbH Im Taubental 7 41468 Neuss Phone: +49 2131 988-1000 info@beko-technologies.com www.beko-technologies.com | BEKO TECHNOLOGIES GmbH Im Taubental 7 41468 Neuss Phone: +49 2131 988-1000 service-eu@beko-technologies.com www.beko-technologies.com |

| INFORMATION | Country-specific manufacturer representation |
|---|--|
|  | You can contact the country-specific manufacturer's representative via the address listed in the address section on the rear cover or by using the contact form on the manufacturer's website. |

1.2 Information about this installation and operation manual

| INFORMATION | Copyright protection |
|---|---|
|  | The contents of the installation and operation manual in the form of text, figures, illustrations, photographs, technical drawings, diagrams and other representations are protected by the copyright of the manufacturer. The distribution as well as the duplication of this document, the exploitation and the communication of its contents are prohibited unless expressly authorised. |

| Publication date | Revision | Version | Reason for change | Scope of amendment |
|------------------|----------|---------|----------------------------------|---|
| 1 August 2022 | 03 | 00 | Editorial revision | New document |
| 1 February 2024 | 04 | 00 | Technical changes to the product | "4. Technical data" on page 19 "7. Electrical installation" on page 28 |

The installation and operation manual, hereinafter referred to as the manual, must always be kept close to the product and be in a permanently legible condition.

The manual must be handed over along with the product if it is sold or passed on.

| NOTE | Follow the instructions given in the manual |
|---|--|
|  | This manual contains all the basic information required for safe operation of the product and must be read before any actions are performed. Otherwise personal and material hazards as well as malfunction and device failure are possible. |

2. Safety

2.1 Use

The **BEKOMAT® 32U Built-in**, also referred to in the following as the product or **BEKOMAT®**, is an electronically level-controlled condensate drain used for discharging condensate in pressurised systems. The **BEKOMAT®** is able to drain condensate at operating pressure with no pressure loss.

2.1.1 Intended use

Any use of this system other than the use described in this manual is hereby deemed to be non-intended and can cause a hazard for the safety of people and the environment.

The following must be noted for intended use:

- Read and follow the manual.
- Only use the product and the accessories in indoor areas.
- Only use the product and accessories within the operating parameters given in the “Technical Data”.
- Only use the product and accessories within the operating parameters specified in the “Technical data” section of this manual and in accordance with the agreed terms of supply.
- Only use the product and accessories with media which are free of caustic, aggressive, corrosive, toxic, flammable, oxidising and inorganic components. In cases of doubt an analysis must be carried out.
- Only use the product and accessories in surroundings where splash water is the maximum possible water exposure that can occur. The splash water must be free of corrosive components.
- Only use the product and accessories in areas which are free of toxic and corrosive chemicals and gases.
- Use the product and accessories only within a piping system designed for the operating parameters specified in section “4. Technical data” on page 19, with appropriate connections, pipe diameters and installation clearances.
- Only use the product and accessories outside potentially explosive atmospheres.
- Only use the product and accessories away from direct solar radiation and heat sources as well as areas subject to frost.
- Only combine the product and the accessories with the recommended manufacturer products and components indicated in this manual.
- Adhere to the prescribed maintenance schedule.

Before using the product and the accessories, the operating company must make sure that all conditions and prerequisites for intended use are given.

The product and the accessories have been exclusively designed for stationary use in a commercial or industrial area. All of the assembly, installation, operation, maintenance, disassembly and disposal work described must be performed exclusively by qualified skilled technical personnel.

2.1.2 Reasonably foreseeable inappropriate use

A case of reasonably foreseeable inappropriate use is deemed to have occurred if the product or the accessories are used in any other way than that described in the "Intended use" section. Reasonably foreseeable inappropriate use includes the use of the product or the accessories in a manner not intended by the manufacturer or supplier but which may result from foreseeable human behaviour.

Reasonably foreseeable inappropriate use includes:

- The execution of any kind of modification, in particular constructive and process-technology related interventions.
- The suspension, bridging or non-application of existing or recommended safety equipment.
- Using the product and accessories in piping systems with carbon dioxide as the operating medium.

This list is not exhaustive as not all possible inappropriate use can be foreseen in advance. If the operating company is aware of any inappropriate use of the product or accessories which are not listed here, the manufacturer must be informed immediately.

2.2 Responsibility of the operating company

The responsible operating company must ensure the following to prevent accidents, incidents and adverse effects on the environment:

- Before all actions, check to ensure that the manual available does in fact belong to the product.
- The product and the accessories are used, serviced and repaired in accordance with the intended use.
- The product and accessories are only used with the recommended and fully operable safety equipment.
- All mounting, installation and maintenance work must be carried out exclusively by qualified skilled technical personnel.
- Personnel have the necessary personal protective equipment available and also use this equipment.
- Suitable technical safety measures are taken so that the permissible operating parameters are adhered to.
- Keep all safety symbols and the type plate on the product in a legible state. Replace damaged and illegible marking immediately.

2.3 Target group and personnel

This manual addresses the personnel listed below who are involved with work on the product or the accessories.

| INFORMATION | Personnel requirements |
|---|---|
|  | <ul style="list-style-type: none"> • Minors are strictly prohibited from working with and on the product and its accessories. • The personnel may not execute any actions on the product or the accessories when they are under the influence of drugs, medications, alcohol or other substances that may impair their consciousness. |

Operating personnel

Operating personnel are persons who are able to operate the product and the accessories safely on the basis of knowledge of the manual and instruction at the product and accessories. Operating personnel can recognise possible malfunctions and dangerous situations independently and arrange for corresponding measures.

Skilled technical personnel - transport and storage

Skilled technical personnel - transport and storage are people who, due to their training, professional experience and qualifications, have all the necessary skills to safely carry out and direct all actions relating to the transport and storage of the product, to independently identify potentially hazardous situations and to take measures to avert danger.

The skills required include, in particular, experience operating hoists, forklifts and lifting equipment and familiarity with locally applicable laws, standards and guidelines relating to transport and storage.

Skilled technical personnel - pressure equipment and systems

Skilled technical personnel specialising in pressure equipment and systems are people who, due to their training, professional experience and qualifications, have all the necessary skills to safely carry out and direct all actions relating to pressurised fluids and systems, to independently identify potentially hazardous situations and to take measures to avert danger.

The skills required include, in particular, experience using measuring equipment and control equipment, as well as familiarity with locally applicable laws, standards and regulations for pressurised systems.

Skilled technical personnel - electrical engineering

Skilled technical personnel - electrical engineering are people who, due to their training, professional experience and qualifications, have all the necessary skills to safely carry out and direct all actions relating to electricity, to independently identify potentially hazardous situations and to take measures to avert danger.









The skills required include, in particular, experience in using electrical plants, measurement and control technology as well as familiarity with locally applicable laws, standards and regulations for dealing with electrical equipment and systems.

Skilled technical personnel - product servicing

Skilled technical personnel - product servicing are people who have the skills and qualifications stated in all the skilled personnel definitions named above. Skilled technical personnel - product servicing must have documented proof of training and authorisation for all work on the product.

2.4 Explanation of the symbols used

The symbols used below indicate safety-relevant and important information which must be adhered to when handling the product and to ensure safe and optimum operation.

| Symbol | Description / explanation |
|---|--|
|  | General warning symbol (danger, warning, caution) |
|  | Warning: pressurised system |
|  | Warning: electric voltage |
|  | Read and follow the installation and operation manual |
|  | General instruction symbol |
|  | Wear safety footwear |
|  | Use protective gloves (cut-proof and liquid-resistant) |
|  | Wear safety goggles with side shields |
|  | General information |

2.5 Safety instructions and warning notices

This section provides an overview of all the important safety aspects for personal protection as well as for the safe and problem-free operation of the product and accessories.

The following sections list the dangers posed by this product and the accessories even with intended use. To minimise the risk of personal injury and damage to property and to avoid dangerous situations, observe the safety instructions listed and adhere to the warning notices in the other sections of this manual.

Basic warning notices and the necessary qualifications of skilled technical personnel are always listed at the beginning of the section in the “Warning notices” section.

Warning notices related to specific actions are printed directly before potentially hazardous procedures or sequences of actions.

Failure to observe safety instructions and warning notices can result not only in personal injury, but also in malfunctions, device failure and damage to property.

2.5.1 Basic safety instructions

- Before starting work, refer to the technical documentation for the entire system and observe the overall operating instructions.
- Carry out a risk assessment before starting work on site (last minute risk assessment).
- Use suitable personal protective equipment for all work.
- Set up a safety area around the working area during all installation, maintenance and repair work.
- Use existing system-specific protection procedures (e.g., LOTO procedure) in order to safely de-energise and isolate the system or system sections.

2.5.2 Safe operation

The following actions may result in serious injury or death:

- Start-up and operation of the product and accessories outside the permissible limit values and operating parameters
- Unauthorised interference and unauthorised modifications of the product and accessories

To guarantee the safe operation of the product and accessories, observe the following:

- Observe the limits and operating parameters specified on the type plate and in the manual.
- Check whether the permissible operating parameters have been changed or restricted by the use of accessories.
- Observe the requirements regarding installation location and ambient conditions.
- Adhere to the maintenance intervals.

2.5.3 Sudden escape of pressurised fluids

The following situations may result in serious injury or death:

- Contact with fast or suddenly escaping fluids
- Bursting system parts
- Whipping of pressurised hoses and pipes

For the safe handling of pressurised systems, observe the following:

- Observe the following safety rules during all work:
 1. Shut down the system or system section.
 2. Secure the system or system section against restarting.
 3. Reduce the pressure in the system or all system sections to the ambient pressure.
e.g. by slowly releasing the pressure in a controlled manner via relief valves
 4. Lock out and tag out the system or system section so that it cannot be pressurised again.
- Check the pressurised system or system section for safety, contamination and possible damage.
- Before pressurisation, check all system connections for leak tightness and tighten if necessary.
- Make absolutely sure to charge the system or system section with pressure slowly.
- Avoid pressure blows and high differential pressures.
- Compensate any vibrations occurring in the pipe network by using vibration dampers.

2.5.4 Electric voltage

Contact with live components may result in serious personal injury or death.

To ensure the safe handling of live components, observe the following:

- Only connect the product and the accessories to the power supply if they are undamaged.
- Comply with all locally applicable legal requirements and regulations during installation.
- Provide a circuit breaker in the power supply within easy reach of the product.
→ The circuit breaker disconnects all current-carrying conductors.
- Only operate the product and accessories with the cover complete and closed, the electronics housing closed, or the switch cabinet closed.
- Before starting work on the product:
 1. Disconnect
→ Disconnect the product from all poles and all sides
 2. Secure against restarting
 3. Determine the absence of voltage at all poles
→ With suitable and permissible measuring device (e.g. two-pole voltage tester)
 4. Earth and short circuit

2.5.5 Transport and storage

Inappropriate transport or storage may result in personal injury or damage to property.

In order to ensure safety during the transport and storage of the product and accessories, observe the following:

- Use personal protective equipment during all work with packaging material.
- Handle packaging, the product and accessories carefully.
- Transport and handle the product and accessories according to the markings on the packaging.
- Use only proper transportation, lifting and lashing equipment that is in proper working order.
- Use only transportation, lifting and lashing equipment that are rated for the total weight of the product.
- Always adhere to the permissible transport and storage parameters.
- Store the product and accessories only outside of areas exposed to direct sunlight and heat sources.

2.5.6 Installation

Inappropriate assembly or electrical installation of the product and accessories may result in personal injury and damage to property as well as impair operation.

For safe assembly and electrical installation, observe the following:

- Install the product, the accessories, and all parts and materials used so that they are not subject to mechanical tension.
- Check all plug-type connections for a correct fit.
- Avoid a stumbling hazard by routing cables and hoses accordingly.
- Avoid mechanical strain on the cables.
- Fix and fasten hoses in such a way that they cannot flap around.
- Install the inlet lines as fixed pipes.

2.5.7 Maintenance

Inappropriate completion of maintenance and repair work may result in serious personal injuries or death.

For safe maintenance and repairs, observe the following:

- Before starting work, depressurise the pressurised product and accessories and secure them against unintentional pressurisation.
- Before starting work, isolate the product and accessories from the power source and secure them against being switched back on again unintentionally.
- Only use materials approved for the respective application.
- Use only suitable tools that are in proper working order.
- Only use cleaned pipes and hoses that are free of dirt and corrosion.
- Never use abrasive or aggressive cleaning agents or solvents which could damage the outer coating (e.g. markings, type plate, corrosion protection, etc.).
- Never clean the device with hard or pointed implements.
- Use only the specified materials and media for cleaning.
- Observe statutory, local and in-house hygiene regulations.
- Pay attention to order and cleanliness during maintenance and repair work. Prevent contamination from entering the opened product or accessories. Put dismantled components and accessories aside in a safe place immediately after dismantling.
- After completing maintenance and repair work, remove all tools and cleaning agents used, as well as all parts that are no longer needed, from the work area.
- Only dispose of the product and accessories when cleaned and freed of any residue.
- Dispose of all components, parts, operating and auxiliary materials as well as cleaning agents professionally and in accordance with all locally applicable legal requirements and regulations.
- Dispose of electrical and electronic components using a specialist disposal company or return them to manufacturer.

2.5.8 Handling hazardous substances

Contact with condensate containing substances which endanger health and the environment can pose a health hazard, causing irritation and/or damage to the eyes, skin and mucous membranes. In addition, contaminated condensate must be prevented from entering the sewage system, bodies of water or the ground.

For the safe handling of polluted condensate, observe the following:

- Use suitable protective equipment when handling condensate.
- Collect and dispose of any leaking or spilled condensate in accordance with locally applicable legal requirements and regulations.

2.5.9 Working on electronic components

Electrostatic discharge (ESD) can cause damage to electronic components, and malfunctions, device failures or material damage are possible.

- Take proper measures to prevent electrostatic discharge (e.g. earthing, potential equalisation, ESD-compatible dissipative work pads etc.).

2.5.10 Use of spare parts, accessories or materials

The use of incorrect spare parts, accessories or materials, as well as auxiliary and operating materials, may result in death or serious injury. Malfunction and device failure as well as material damage can occur.

- Only use undamaged original parts, auxiliary and operating materials which are specified by the manufacturer to complete all work.
- Only use the materials approved for the respective application and suitable tools in proper working order.
- Only use cleaned pipes that are free of dirt and corrosion.
- Only use electric components and materials that comply with locally applicable legal requirements and regulations (standards, directives etc.) for electrical safety.

2.6 Warning notices

Warning notices warn against dangers when handling the product and accessories.

Observe the warning notices in order to avoid personal injury, damage to property and impaired operation.

Structural set up:

| SIGNAL WORD | Type and source of danger |
|---|--|
|  Symbol | Possible consequences if the danger is ignored |
| | <ul style="list-style-type: none"> • Measures to prevent the danger |

Signal words:

| | |
|----------------|--|
| DANGER | Imminent hazard Consequences of non-compliance: Death or serious personal injury |
| WARNING | Imminent hazard Consequences of non-compliance: Death or serious personal injury are possible |
| CAUTION | Potential hazard Consequences of non-compliance: Personal injury or damage to property are possible |
| NOTE | Additional notes Consequences of non-compliance: Damage to property, malfunction and device failure are possible. No hazard to people or endangerment of safe operation. |

3. Product information

3.1 Product description

The **BEKOMAT®** is an electronically level-controlled condensate drain used for draining off condensate in pressurised systems. The **BEKOMAT®** is able to drain condensate at operating pressure with no pressure loss.

The **BEKOMAT®** has a dry contact on the power supply board. It can be used to display a fault message at a remote maintenance centre.

The **BEKOMAT®** has an option for the connection of an external TEST button. This makes it possible for condensate to be discharged via remote control. If the external contact is closed, the solenoid valve opens in the same way as when the TEST button is pressed on the top cover, causing the **BEKOMAT®** to discharge condensate.

3.2 Type plate

The type plate, which contains identification information and operating parameters for the product, is located on the bottom cover.

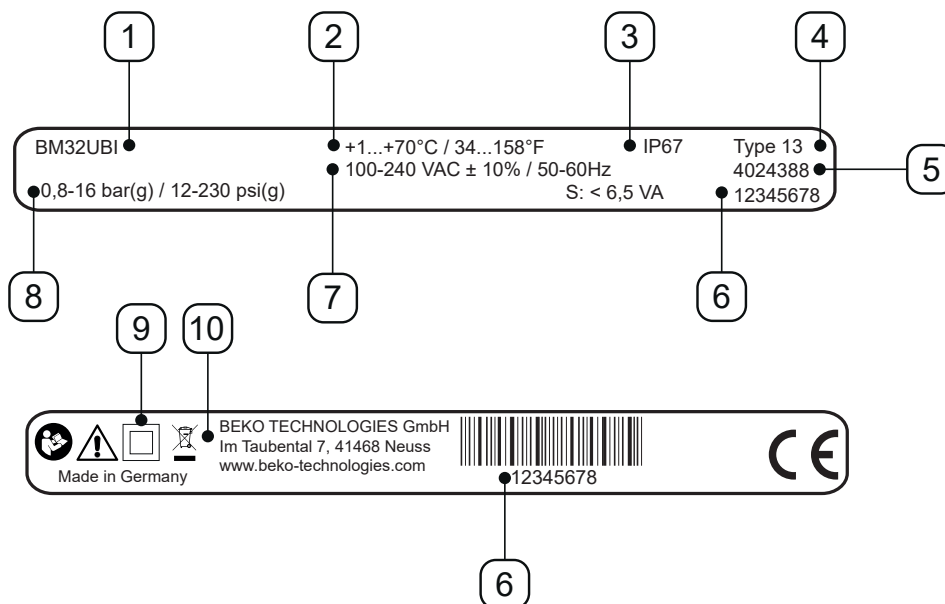

Example illustration

| Pos. No. | Description / explanation |
|----------|---------------------------|
| [1] | Product name |
| [2] | Operating temperature |
| [3] | IP protection class |
| [4] | Enclosure rating |
| [5] | Material number |
| [6] | Serial number |
| [7] | Operating voltage |
| [8] | Operating pressure |
| [9] | IP rating II |
| [10] | Manufacturer |

For more information, refer to section “2.4 Explanation of the symbols used” on page 9.

3.3 Product overview

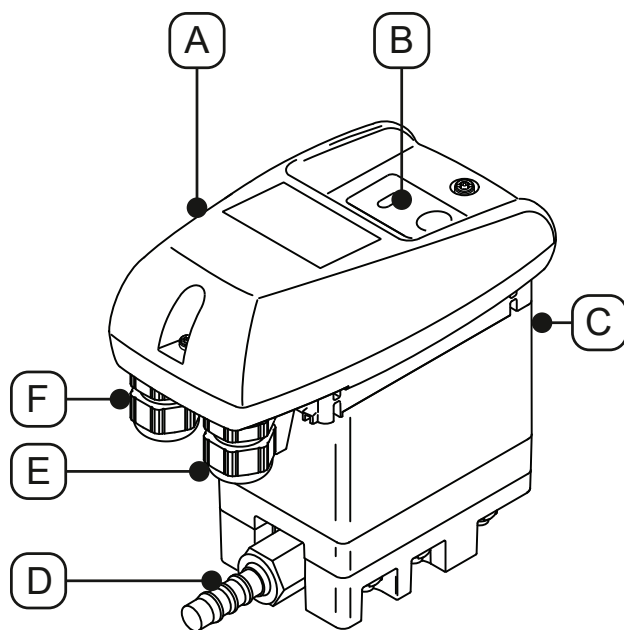

| Pos. No. | Description / explanation |
|----------|---------------------------|
| [A] | Control unit, complete |
| [B] | Control panel |
| [C] | Condensate inlet |

| Pos. No. | Description / explanation |
|----------|---------------------------|
| [D] | Condensate drain |
| [E] | Right cable gland |
| [F] | Left cable gland |

3.4 Scope of delivery

The table below shows the scope of delivery of the product:

| Illustration | Description / explanation |
|--------------|--|
| | BEKOMAT® 32U Built-in |
| | Original installation and operation manual |
| | 1 x connector |

3.5 Exploded drawing



| Pos. No. | Description / explanation |
|----------|---------------------------|
| [1] | Screw 3.5 x 10 mm |
| [2] | Top cover |
| [3] | Moulded seal |
| [4] | Sensor board |
| [5] | Bottom cover |
| [6] | Screw fitting |
| [7] | Plug |

| Pos. No. | Description / explanation |
|----------|---------------------------|
| [8] | Hose connection |
| [9] | Tapered plug |
| [10] | Service-Unit |
| [11] | O-ring 20 x 2 mm |
| [12] | Screw plug G1/2" |
| [13] | Sealing mat |

3.6 Function description

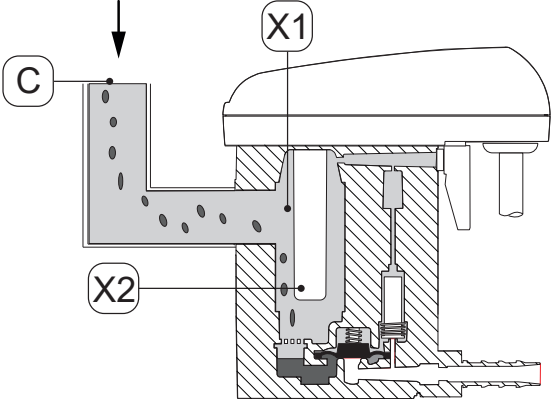
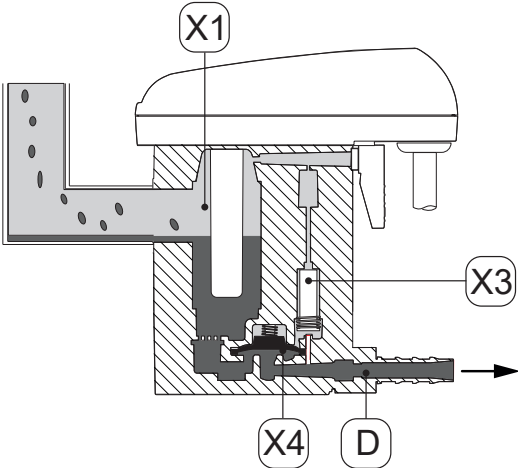
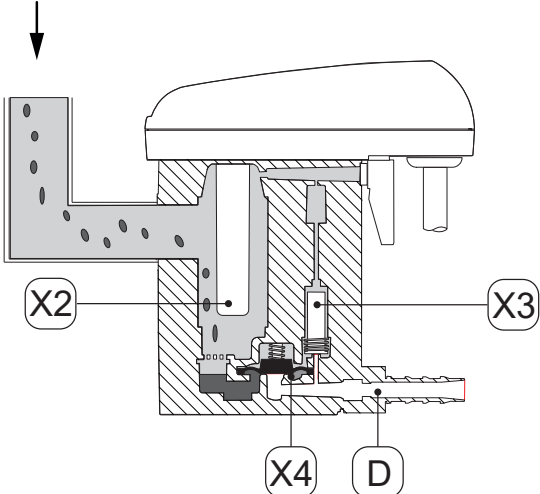
| Illustration | Description / explanation |
|---|---|
|  | <p>The condensate flows via the condensate inlet [C] into the BEKOMAT® and collects in the housing [X1].</p> <p>The filling level in the housing [X1] is continuously monitored by a capacitive sensor in the sensor tube [X2].</p> |
|  | <p>Once the condensate has reached the maximum fill level, the pilot valve [X3] is activated with the controller.</p> <p>The pilot valve [X3] is activated and the area above the membrane [X4] is depressurised.</p> <p>The membrane [X4] lifts off the valve seat and the excess pressure in the housing [X1] presses the condensate into the condensate drain [D].</p> |
|  | <p>When the sensor in the sensor tube [X2] is no longer covered by condensate, the controller switches the pilot valve [X3] and pressure builds up above the membrane [X4].</p> <p>The membrane [X4] is pressed against the valve seat and the condensate drain [D] is sealed and closed off.</p> |

4. Technical data

4.1 Operating parameters

| BEKOMAT® | 32U Built-in |
|---|--|
| Relative ambient humidity | 10 ... 80 %, without condensation |
| Maximum operating height | 3000 m 3280.84 yd |
| Minimum / maximum operating pressure | 0.8 ... 16 bar(g) 12 ... 230 psi(g) |
| Minimum / maximum operating temperature | +1 ... 70 °C +34 ... +158 °F |
| Average discharge rate | 1.14 l/h 0.30 gal/h |
| Maximum discharge rate (short-term) | 10 l/h 2.64 gal/h |
| Connection*, condensate inlet | 1 x G1/2" internal, maximum screw-in depth: 13.5 mm (1/2 in) |
| Connection, condensate drain | 1 x G1/4" external, hose fitting for hose diameter 8 ... 10 mm (0.31 ... 0.39 in), internal |
| Media | Condensate, oil-contaminated or oil-free |
| Empty weight | 0,8 kg 1.76 lbs |
| Operating voltage | 100 ... 240 VAC ±10% (50 ... 60 Hz) or 24 VAC -10%/+20% (50 ... 60 Hz) or 24 VDC -10%/+20% (see type plate) |
| Power consumption | 6,5 ... 8 VA |
| Degree of protection | IP67 |
| Enclosure rating | Type 13 |
| Overvoltage category (IEC 61010-1) | II |
| Degree of pollution (IEC 61010-1) | 2 |
| Dry contact connection data | AC: max. 250 V / 1 A DC: max. 30 V / 1 A |
| Recommended cable diameter | 5 ... 10 mm 0.23 ... 0.33 in |
| Recommended wire cross-sectional area | 0.75 ... 1.5 mm ² AWG 14 ... 20 |

* The NPT thread version is available as an option.

4.2 Storage and transportation parameters

| BEKOMAT® | 32U Built-in |
|--|----------------------------------|
| Minimum / maximum temperature, storage and transport | +1 ... +70 °C +34 ... +158 °F |

4.3 Materials

| BEKOMAT® | 32U Built-in |
|----------|---|
| Housing | Aluminium and plastic, glass fibre reinforced |
| Membrane | FKM |

4.4 Screw fastening torques

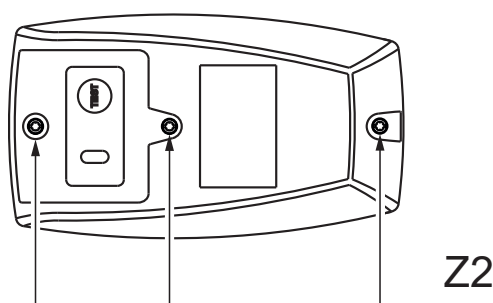
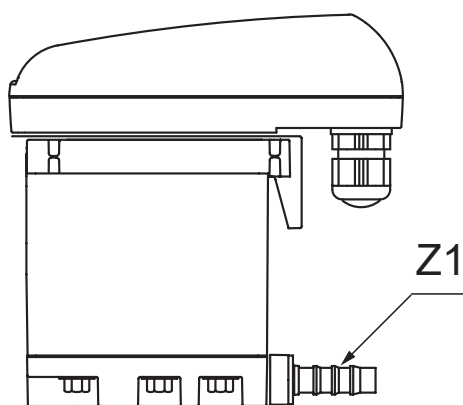

| Pos. No. | Description / explanation | Tightening torques |
|----------|-----------------------------------|---|
| [Z1] | Hose connection, condensate drain | 3 ... 4 Nm (2.21 ... 2.95 ft-lb) |
| [Z2] | Screws, top cover | 0.9 Nm +0.5 Nm (0.66 ft-lb +0.37 ft-lb) |

4.5 Dimensions

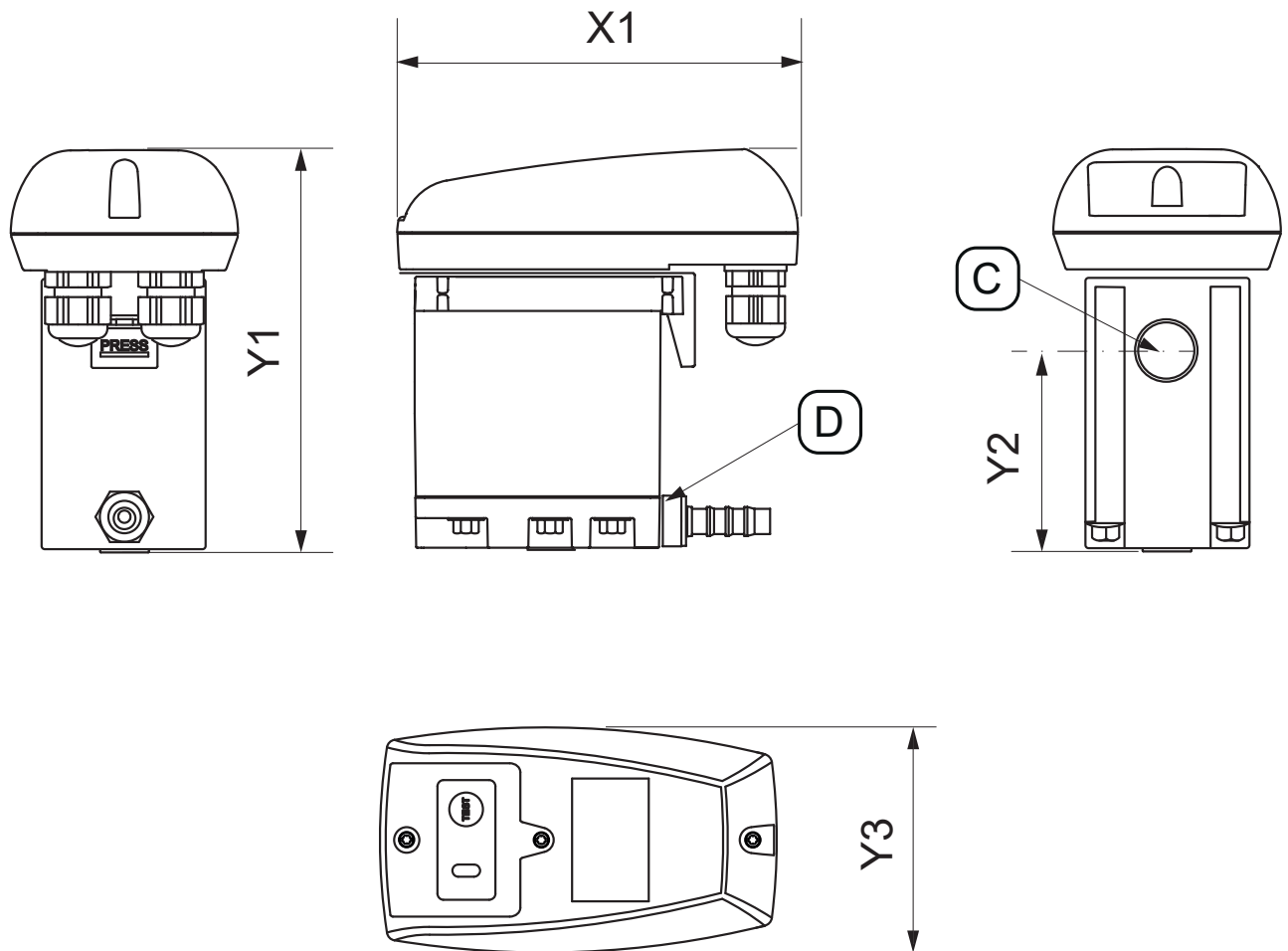

| Pos. No. | BEKOMAT® 32U Built-in |
|------------------------------------|-----------------------------------|
| [X1] | 179 mm 7.05 in |
| [Y1] | 130 mm 5.12 in |
| [Y2] | 65,5 mm 2.58 in |
| [Y3] | 73,4 mm 2.87 in |
| [C] - Connection, condensate inlet | G1/2" (NPT 1/2") |
| [D] - Connection, condensate drain | G1/4" Ø 8-10 (dia 0.32 - 0.39) |

4.6 Installation dimensions

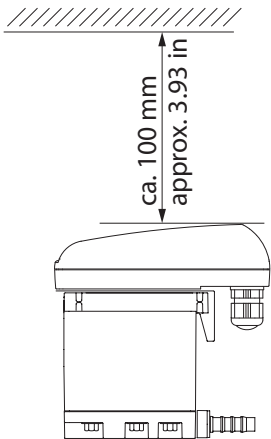
| Illustration | Description / explanation |
|--|--|
|  <p>The illustration shows a side view of the BEKOMAT 32U unit. A hatched line above the unit indicates a required clearance. A vertical double-headed arrow between this line and the top of the unit is labeled 'ca. 100 mm' and 'approx. 3.93 in'.</p> | <p>Allow sufficient assembly space above the top cover at the place of installation so that the LEDs are visible and the TEST button can be pressed.</p> |

4.7 Terminal diagram

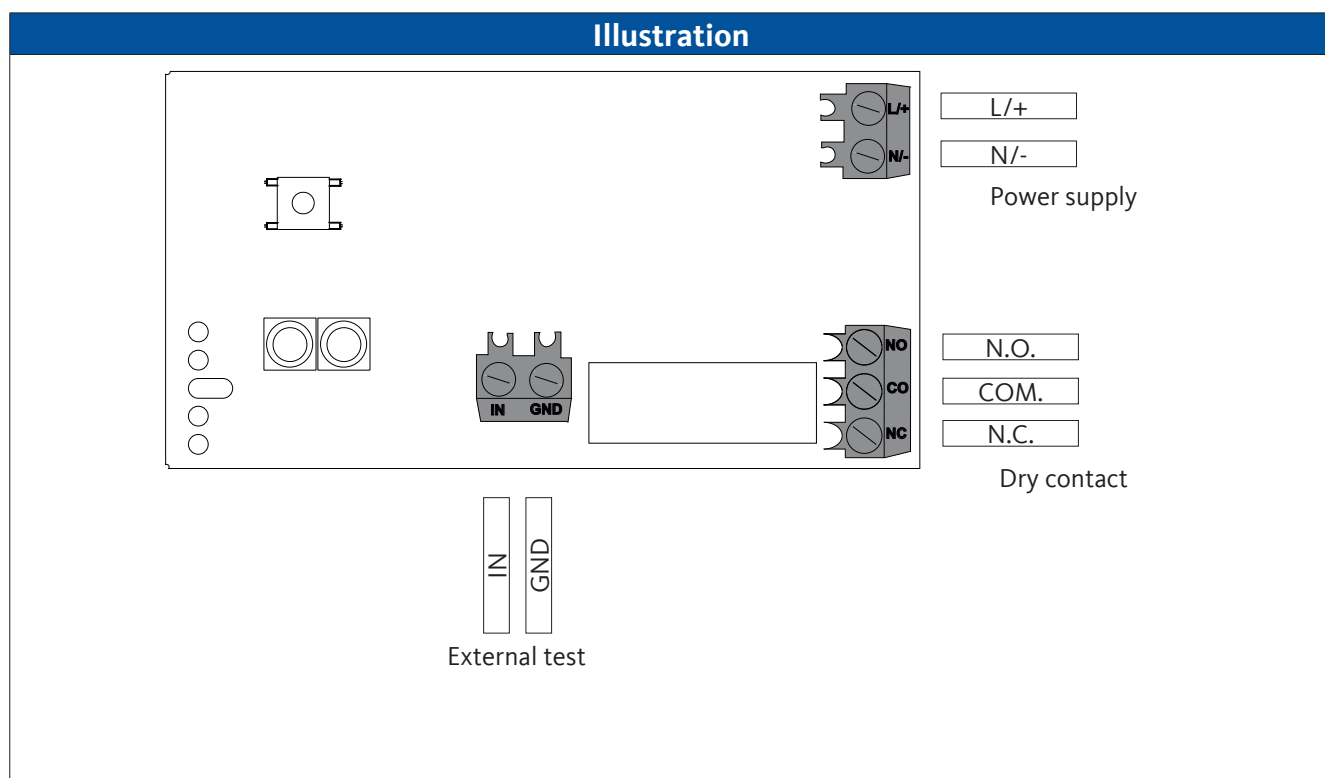



5. Transport and storage

5.1 Warning notices

Personnel

Skilled technical personnel - transport and storage (see section “2.3 Target group and personnel” on page 8)

| CAUTION | Inappropriate transport or storage |
|---|---|
|  | <p data-bbox="448 562 1430 595">Inappropriate transport or storage may result in personal injury or damage to the device.</p> <ul style="list-style-type: none"> <li data-bbox="448 607 1326 640">• Use personal protective equipment during all work with packaging material. <li data-bbox="448 640 1114 674">• Handle packaging, the product and accessories carefully. <li data-bbox="448 674 1465 730">• Use only proper transportation, lifting and lashing equipment that is in proper working order. <li data-bbox="448 730 1469 797">• Use only transportation, lifting and lashing equipment that are rated for the total weight of the product. <li data-bbox="448 797 1238 831">• Always adhere to the permissible transport and storage parameters. |
| NOTE | Handling packaging material |
|  | <p data-bbox="448 913 1334 947">Inappropriate disposal of packaging materials can cause environmental damage.</p> <ul style="list-style-type: none"> <li data-bbox="448 969 1453 1037">• Dispose of the packaging material in accordance with the applicable legal requirements and provisions of the country and place of use. |

5.2 Transport

After transporting and removing the packaging material, inspect the product for possible transport damage. If you find any damage, notify the carrier company, the manufacturer or one of its agents immediately.

Transport the product as follows:

- Only transport the product in its original packaging.
- Handle packaging and the product with care.
- Note the transport weight specification and marking on the packaging.
- Secure the packaging and the product against slipping and falling during transport.
- Pack all parts impact-proof using suitable material.

5.3 Storage

Store the product and the accessories as follows:

- Adhere to the storage parameters in section “4.2 Storage and transportation parameters” on page 20.
- Store in a closed, dry as well as frost-free room.
- Store protected from external influences of the weather, direct sunlight and sources of heat.
- Secure against falling over and protect against vibrations at the storage location.

6. Installation

6.1 Warning notices

| Personnel | |
|---|--|
| Skilled technical personnel - pressure equipment and systems (see section "2.3 Target group and personnel" on page 8) | |

| | |
|---|---|
| DANGER | Sudden escape of pressurised fluids |
|  | <p>There is a danger of death or serious personal injury resulting from contact with fast or suddenly escaping fluids or through bursting system parts.</p> <ul style="list-style-type: none"> • Before starting work, depressurise the pressurised system and secure it against unintentional pressurisation. • Mount all pipes and hoses free of mechanical stress. |

6.2 Installation requirements

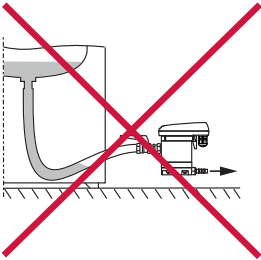
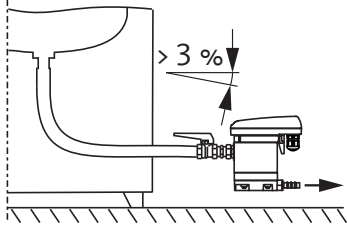
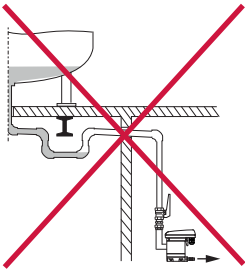
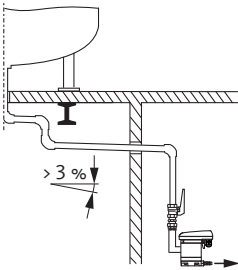
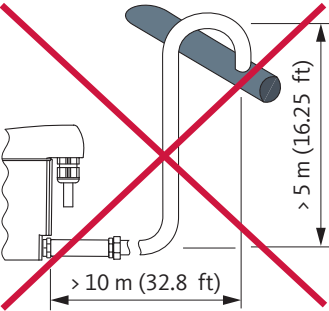
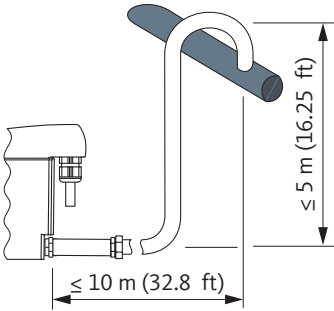
| Wrong | Correct | Description / explanation |
|---|---|--|
|  |  | <p>Continuous fall > 3% in hoses</p> <ul style="list-style-type: none"> • When using hoses as the inlet line, ensure a continuous fall >3%. • Make sure that no water pockets form. |
|  |  | <p>Continuous fall > 3% in pipes</p> <ul style="list-style-type: none"> • When installing the inlet line pipe, ensure a continuous fall >3%. • Make sure that no water pockets form. |
|  |  | <p>Drain line design</p> <ul style="list-style-type: none"> • Do not use shut-off valves in the drain line. • Only connect the BEKOMAT® to the drain line using a hose. <ul style="list-style-type: none"> → The hose compensates for assembly tolerances, vibrations and thermal expansion. • Do not install the drain line on storage or transportation surfaces. • The drain line may be a maximum of 10 m (32.8 ft) long and installed at a maximum of 5 m (16.25 ft) rise. <ul style="list-style-type: none"> → The minimum operating pressure increases by 0.1 bar(g) (1.5 psi(g)) per metre of incline. |

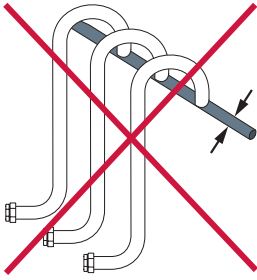
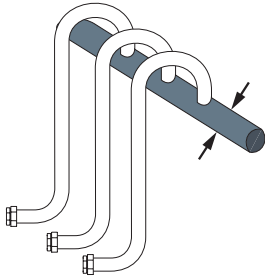
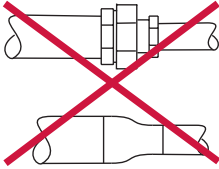
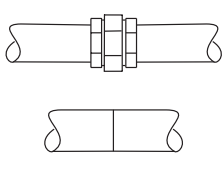
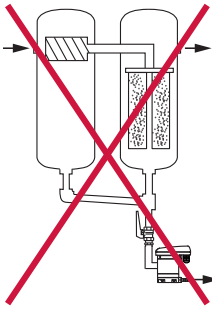
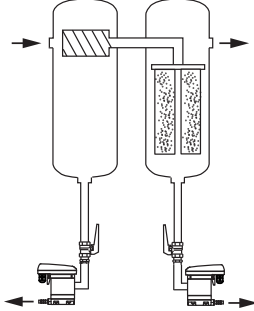
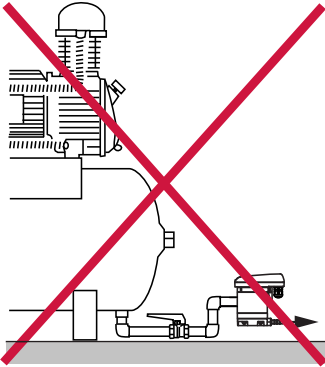
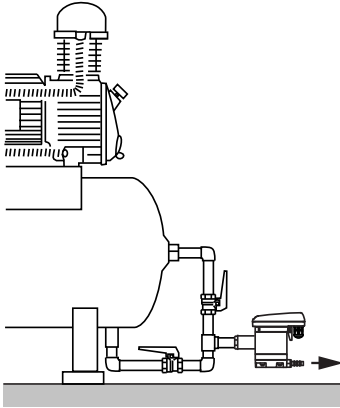
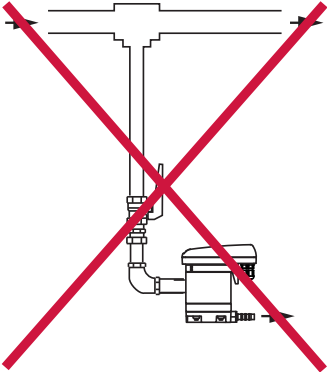
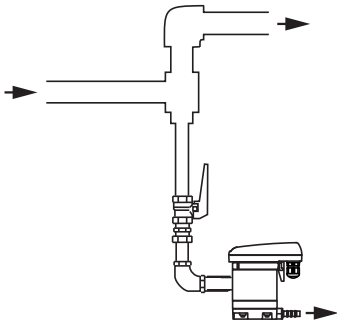
| Wrong | Correct | Description / explanation |
|---|---|---|
|  |  | <p>Manifold design</p> <ul style="list-style-type: none"> The cross-section of the manifold must be at least equal to the sum of the individual cross-sections of the connected inlet lines. Route the manifold with a continuous slope >3%. |
|  |  | <p>Maintain the minimum pipe diameter</p> <ul style="list-style-type: none"> The minimum inside diameter of the inlet line and drain line is 13 mm (0.5 in). Do not restrict or reduce the (minimum) pipe diameter with reducers (reducing nipple fittings). |
|  |  | <p>Bypassing filters</p> <ul style="list-style-type: none"> Discharge each condensate collection point with a separate BEKOMAT®. Do not create filter bypasses. |
|  |  | <p>Ensure venting</p> <ul style="list-style-type: none"> If the slope in the inflow is not sufficient or there are other problems with the inlet, install a venting line. |
|  |  | <p>Discharge from pressurised pipes</p> <ul style="list-style-type: none"> Divert the flow of gas to provide a deflecting surface to discharge the fluid components in the gas. |

6.3 Installation work

For installation and mounting work to be carried out, the following prerequisites must be met, and the preparatory tasks must have been completed.

| Prerequisites | | |
|---|---|--|
| Tools | Material | Protective equipment |
| <ul style="list-style-type: none"> Combination wrench or adjustable wrench | <ul style="list-style-type: none"> Sealants e.g. PTFE Inlet line Drain line Hose, interior diameter 8 ... 10 mm (0.31 ... 0.39 in), length approx. 30 cm (1 ft) | <p>Always to be worn:</p>  |

| Preparatory tasks | |
|-------------------|---|
| 1. | Depressurise the pressurised system or the respective system section and secure it against unintentional pressure build-up. |
| 2. | Get the hose and hose clamp ready for connection to the condensate drain. |

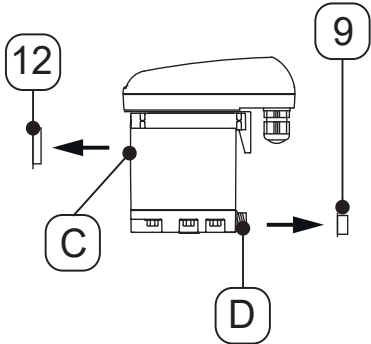
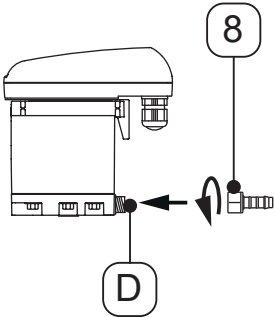
| Installation work | |
|---|--|
| Illustration | Description / explanation |
|  | <ol style="list-style-type: none"> Remove the plugs [9, 12] from the condensate inlet [C] and condensate drain [D]. |
|  | <ol style="list-style-type: none"> Screw the enclosed hose fitting [8] onto the condensate drain [D]. Tighten the hose fitting [8] with a torque of 3 ... 4 Nm (2.21 ... 2.95 ft-lb). |

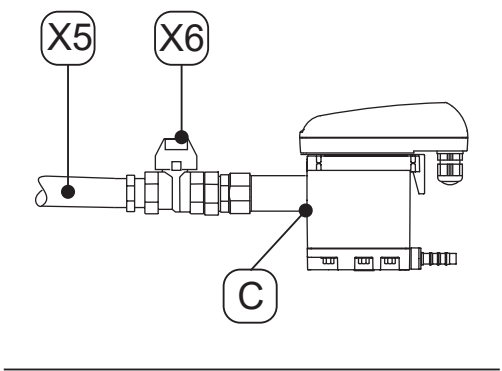
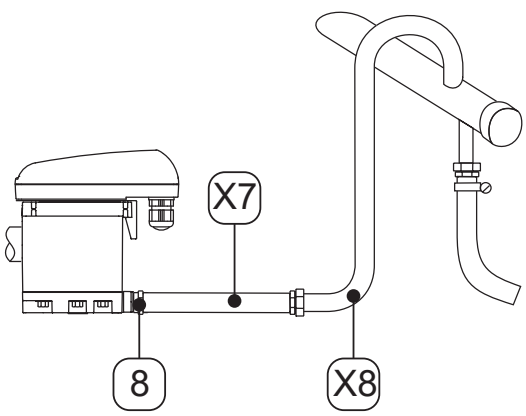
| Installation work | |
|---|---|
| Illustration | Description / explanation |
|  | <p>Recommendation:</p> <ol style="list-style-type: none"> To ensure easy maintenance of the product, install a shut-off valve [X6] in the condensate inlet line [X5]. For the condensate inlet line [X5], apply sealant to the end of a pressure-resistant pipe and screw the latter in at the condensate inlet [C]. |
|  | <ol style="list-style-type: none"> For the condensate drain, push the hose provided [X7] onto the hose fitting [8] and use a hose clamp to secure it. Connect the other end of the hose [X7] to the condensate drain line [X8]. |
| Final steps | |
| 1. | Before pressurisation, check all system connections for leak tightness and tighten if necessary. |

7. Electrical installation

7.1 Warning notices



| Personnel | |
|---|--|
| Skilled technical personnel - electrical engineering (see section "2.3 Target group and personnel" on page 8) | |

| DANGER | Electric voltage |
|---|---|
|  | <p>Contact with electrically live components can result in death or serious injury.</p> <ul style="list-style-type: none"> • Only carry out installation, maintenance and repair work on the product and accessories when they have been isolated from the power source and secured against being switched back on again unintentionally. • Comply with all locally applicable legal requirements and regulations during installation. • Connect the protective conductor (earth connection) according to regulations. |

| WARNING | Ingress of moisture or foreign bodies |
|---|---|
|  | <p>Removing components or opening the product may allow water or foreign bodies to enter the opened product. This can lead to accidents, personal injury and damage to property as well as impaired operation.</p> <ul style="list-style-type: none"> • Protect the product from splashing water or moisture. • Only open the product or remove components in a dry place. • Do not insert any foreign bodies into the openings of the product. • Keep all contact surfaces and openings free of dirt and moisture. |

7.2 Connection work

For connection work to be carried out, the following prerequisites must be fulfilled and the preparatory tasks must have been completed.

| Prerequisites | | |
|--|--|--|
| Tools | Material | Protective equipment |
| <ul style="list-style-type: none"> • Stripping tool • Crimping tool for wire-end ferrules • Screwdriver – flat head size 2.5 mm (0.09 in) • Torx screwdriver - T15 | <ul style="list-style-type: none"> • 2-wire cable for 230 V power supply • 2-wire cable for 24 V power supply • 2/3-wire cable for dry contact (depending on the application) • 2-wire cable for external TEST button • Wire-end ferrules | <p style="text-align: center;">Always to be worn:</p> <div style="display: flex; justify-content: center; gap: 20px;">   </div> |

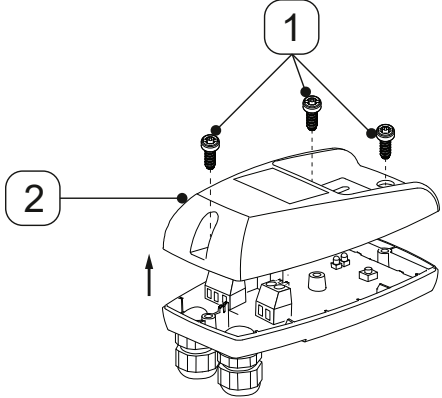
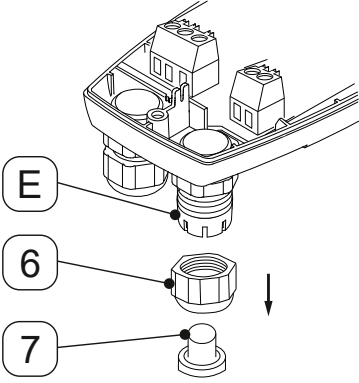
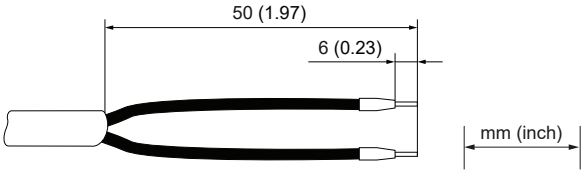
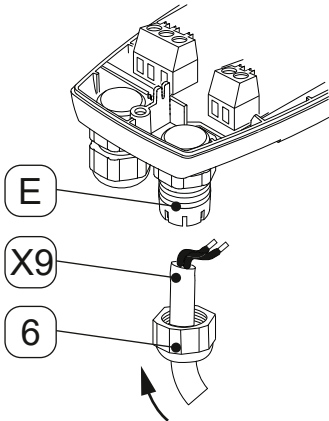

| Preparatory tasks | |
|-------------------|---|
| 1. | Installation is completed (see section "6. Installation" on page 24). |

7.2.1 Connecting the power supply

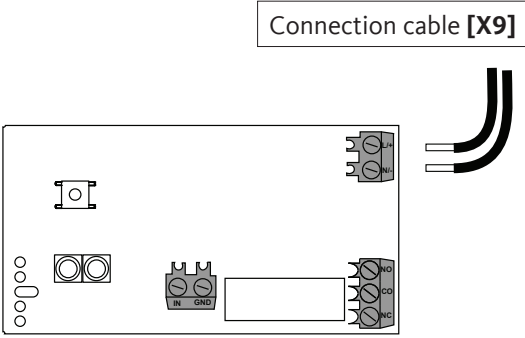
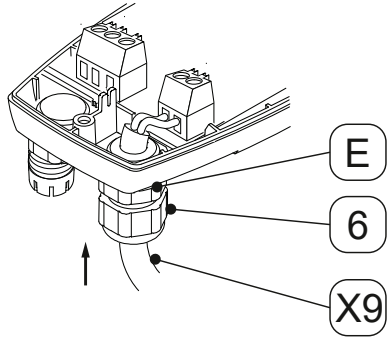
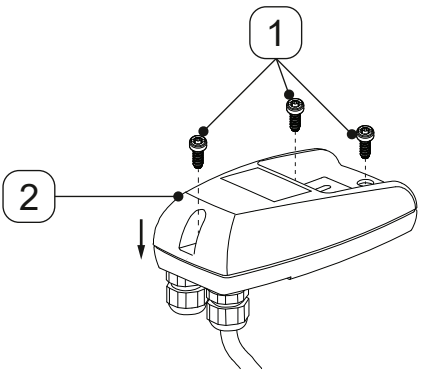
| Connection work | |
|--|---|
| Illustration | Description / explanation |
|  | <ol style="list-style-type: none"> 1. Loosen the 3 screws [1]. 2. Lift the top cover [2] off. |
|  | <ol style="list-style-type: none"> 3. Unscrew the counter nut [6] from the right cable gland [E]. 4. Remove the plug [7] from the counter nut [6]. |
| <p>Connection cable [X9]</p>  | <ol style="list-style-type: none"> 5. Prepare the connection cable [X9]. |
|  | <ol style="list-style-type: none"> 6. Slide the counter nut [6] over the connection cable [X9]. 7. Insert the connection cable [X9] into the right cable gland [E]. |

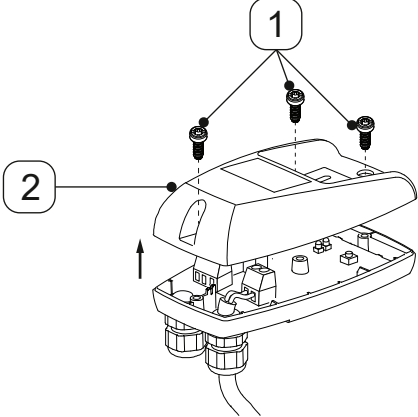
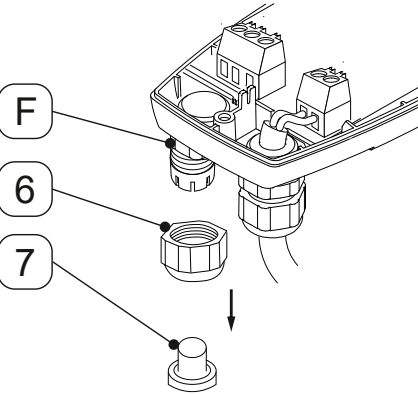
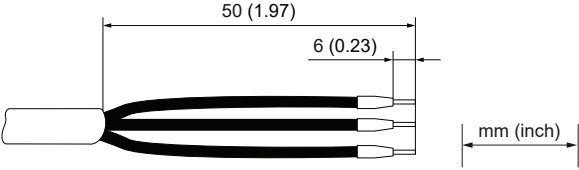

| Connection work | |
|---|---|
| Illustration | Description / explanation |
|  | <p>8. Connect the connection cable [X9] according to the terminal diagram (see “4.7 Terminal diagram” on page 22).</p> |
|  | <p>9. Draw the connection cable [X9] taut.</p> <p>10. Screw the counter nut [6] onto the right cable gland [E].</p> |
|  | <p>11. Set the top cover [2] in place and insert the screws [1].</p> <p>12. Tighten the screws [1] with a torque of 0.9 Nm +0.5 Nm (0.66 ft-lb +0.37 ft-lb).</p> |

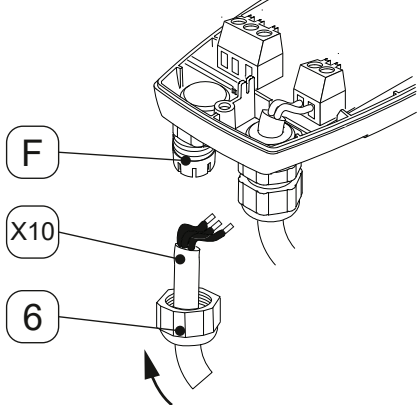
7.2.2 Connecting the dry contact

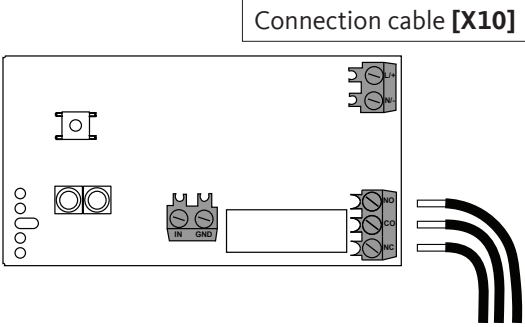
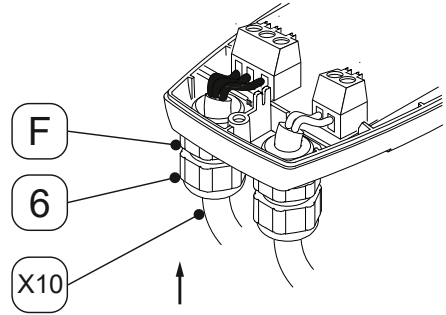
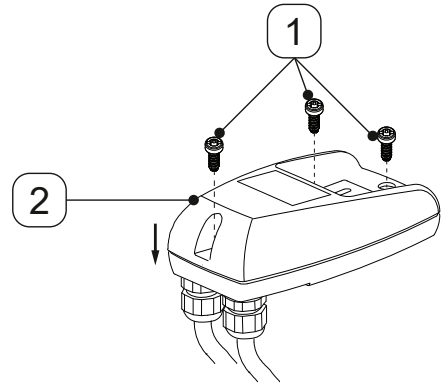
| Illustration | Description / explanation |
|---|--|
|  | <ol style="list-style-type: none"> 1. Loosen the 3 screws [1]. 2. Lift the top cover [2] off. |
|  | <ol style="list-style-type: none"> 3. Unscrew the counter nut [6] from the left cable gland [F]. 4. Remove the plug [7] from the counter nut [6]. |
| <p data-bbox="432 1238 715 1279">Connection cable [X10]</p>  | <ol style="list-style-type: none"> 5. Prepare the dry contact cable (depending on the application). <div data-bbox="831 1361 938 1469" style="display: inline-block; vertical-align: middle;">  </div> <p data-bbox="946 1402 1461 1529">If the external TEST button is to be connected in addition to the dry contact, a 4/5-wire cable must be used for the connection (depending on the application).</p> |
|  | <ol style="list-style-type: none"> 6. Slide the counter nut [6] over the dry contact cable [X10]. 7. Insert the dry contact cable [X10] into the left cable gland [F]. |

| Illustration | Description / explanation |
|---|--|
|  <p>Connection cable [X10]</p> | <p>8. Connect the dry contact cable [X10] as shown in the terminal diagram (see “4.7 Terminal diagram” on page 22).</p> |
|  | <p>9. Draw the connection cable [X10] taut.</p> <p>10. Screw the counter nut [6] onto the left cable gland [F].</p> |
|  | <p>11. Set the top cover [2] in place and insert the screws [1].</p> <p>12. Tighten the screws [1] with a torque of 0.9 Nm +0.5 Nm (0.66 ft-lb +0.37 ft-lb).</p> |

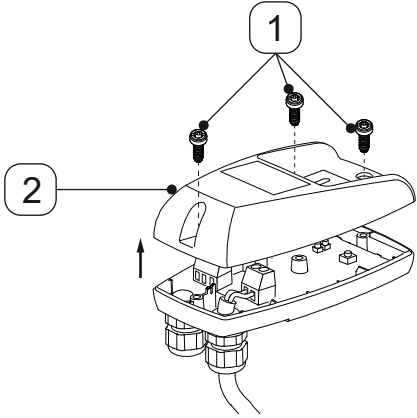
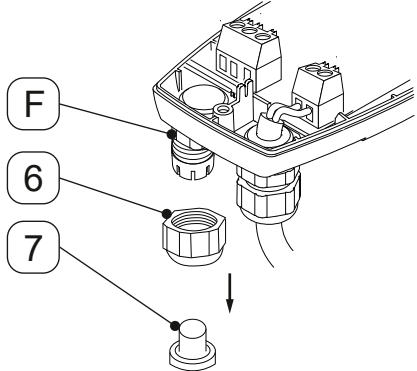
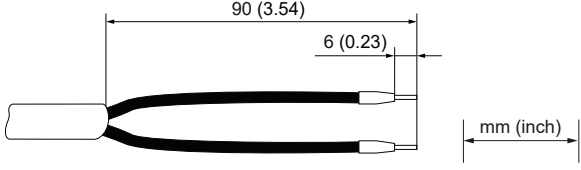

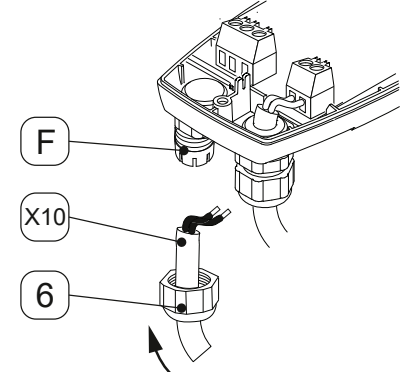
7.2.3 Connecting the external TEST button

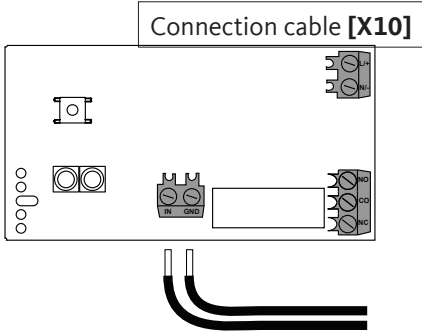
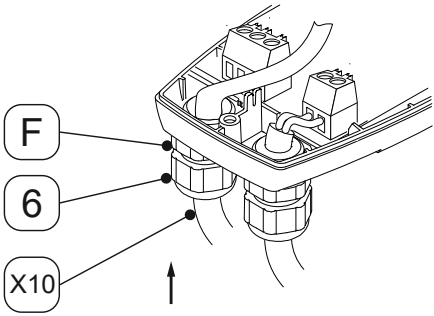
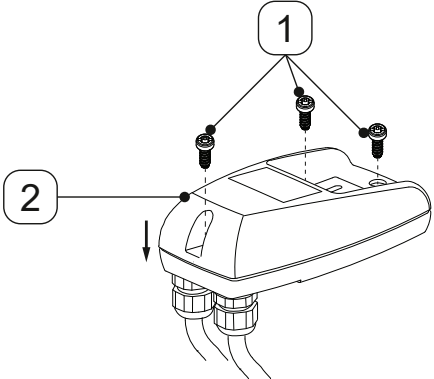
| Illustration | Description / explanation |
|--|---|
|  | <ol style="list-style-type: none"> 1. Loosen the 3 screws [1]. 2. Lift the top cover [2] off. |
|  | <ol style="list-style-type: none"> 3. Unscrew the counter nut [6] from the left cable gland [F]. 4. Remove the plug [7] from the counter nut [6]. |
| <p>Connection cable [X10]</p>  | <ol style="list-style-type: none"> 5. Prepare the connection cable for the external TEST button (depending on the application). <p> If the dry contact is to be connected in addition to the external TEST button, a 4/5-wire cable must be used for the connection (depending on the application).</p> |
|  | <ol style="list-style-type: none"> 6. Slide the counter nut [6] over the connection cable for the external TEST button [X10]. 7. Insert the connection cable for the external TEST button [X10] into the left cable gland [F]. |

| Illustration | Description / explanation |
|---|---|
|  | <p>8. Connect the connection cable for the external TEST button [X10] as shown in the terminal diagram (see “4.7 Terminal diagram” on page 22).</p> |
|  | <p>9. Tighten the connection cable for the external TEST button [X10].</p> <p>10. Screw the counter nut [6] onto the left cable gland [F].</p> |
|  | <p>11. Set the top cover [2] in place and insert the screws [1].</p> <p>12. Tighten the screws [1] with a torque of 0.9 Nm +0.5 Nm (0.66 ft-lb +0.37 ft-lb).</p> |

8. Start-up procedure

8.1 Warning notices

| Personnel | |
|---|---|
| Skilled technical personnel - pressure equipment and systems and skilled technical personnel - electrical (see section "2.3 Target group and personnel" on page 8) | |
| DANGER | Sudden escape of pressurised fluids |
|  | <p>There is a danger of death or serious personal injury resulting from contact with fast or suddenly escaping fluids or through bursting system parts.</p> <ul style="list-style-type: none"> • Before pressurisation, check all system connections for leak tightness and tighten if necessary. • Slowly pressurise the system. |
| DANGER | Electric voltage |
|  | <p>Contact with electrically live components can result in death or serious injury, as well as malfunction, device failure or material damage.</p> <ul style="list-style-type: none"> • Only operate the product and accessories with the cover complete and closed, the electronics housing closed, or the switch cabinet closed. • Check the product and accessories before commissioning in accordance with the locally applicable legal requirements and regulations. |

8.2 Start-up steps

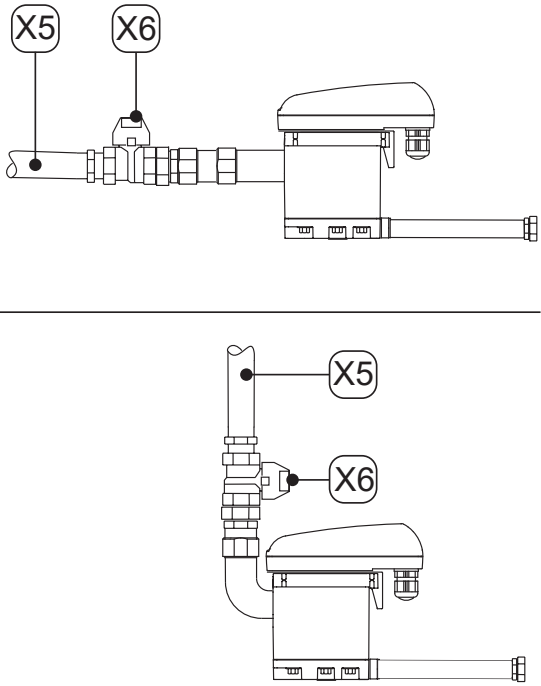
| Illustration | Description / explanation |
|---|---|
|  | <ol style="list-style-type: none"> 1. Connect the power supply. 2. Slowly pressurise the system section (e.g., by slowly opening the recommended shut-off valve [X6] in the condensate inlet line [X5]). 3. Carry out a functional test (see "10.3.2 Functional test" on page 43). |

9. Operation

9.1 Warning notices

| Personnel | |
|--|--|
| Operating personnel (see section “2.3 Target group and personnel” on page 8) | |

| | |
|---|--|
| DANGER | Electric voltage |
|  | Contact with electrically live components can result in death or serious injury. |
| | <ul style="list-style-type: none"> Only operate the product and accessories with the cover complete and closed, the electronics housing closed, or the switch cabinet closed. |

9.2 Operating states

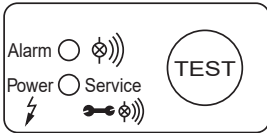
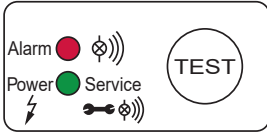
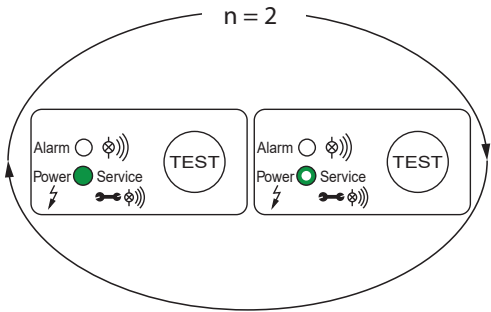
| Illustration | Description / explanation |
|---|--|
|  | <p>Disconnected</p> <ul style="list-style-type: none"> All LEDs are off |
|  | <p>Switch on / power-on self-test</p> <ul style="list-style-type: none"> All LEDs are on for 1 second The BEKOMAT® carries out a diagnosis of the electronics unit |
|  | <p>Positive power-on self-test Number of repetitions n = 2x</p> <ul style="list-style-type: none"> The red ALARM LED is off The green POWER LED is on (100 % brightness) while the solenoid valve is cycling The green POWER LED is on (50 % brightness) while the solenoid valve is not cycling → The BEKOMAT® switches to normal operation |

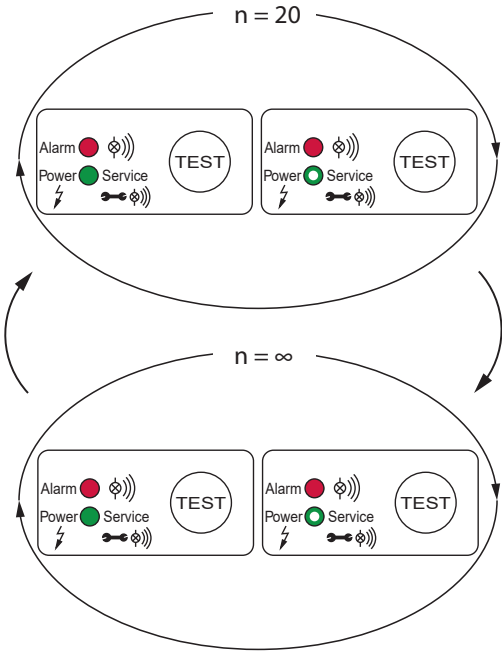
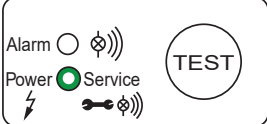
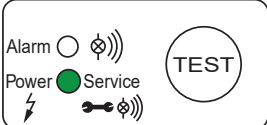
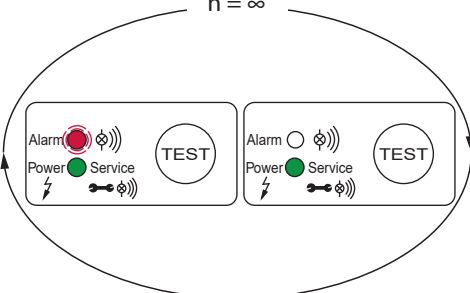
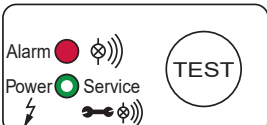

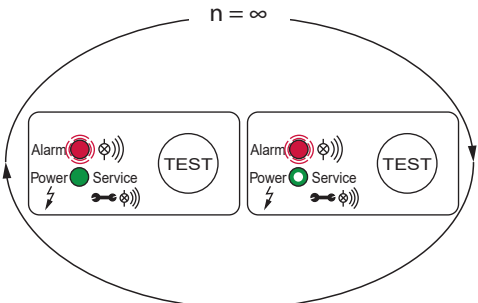
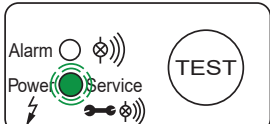
| Illustration | Description / explanation |
|---|---|
|  | <p>Negative power-on self-test Number of repetitions n = 20x</p> <ul style="list-style-type: none"> The red ALARM LED is on The green POWER LED is on (100 % brightness) while the solenoid valve is cycling quickly The green POWER LED is on (50 % brightness) while the solenoid valve is not cycling <ul style="list-style-type: none"> → The BEKOMAT® goes into fail-safe mode (continuous loop n = ∞) The solenoid valve cycles once per second |
|  | <p>Ready for operation (normal operating mode)</p> <ul style="list-style-type: none"> The red ALARM LED is off The green POWER LED is on (50 % brightness) |
|  | <p>Discharge procedure (TEST button pressed briefly)</p> <ul style="list-style-type: none"> The red ALARM LED is off The green POWER LED is on (100 % brightness) while the solenoid valve is cycling |
|  | <p>Pre-alarm (TEST button pressed > 1 minute and < 5 minutes)</p> <ul style="list-style-type: none"> The red ALARM LED flashes The green POWER LED is on (100% brightness) |
|  | <p>Alarm (TEST button pressed > 5 minutes)</p> <ul style="list-style-type: none"> The red ALARM LED is on The green POWER LED is on (50 % brightness) |

| Illustration | Description / explanation |
|---|---|
|  | <p>Alarm mode (condensate drain malfunction)</p> <ul style="list-style-type: none"> • The red ALARM LED flashes • The green POWER LED is on (50 % brightness) <ul style="list-style-type: none"> → The solenoid valve cycles every 4 minutes <p>After the malfunction has been eliminated, the BEKOMAT® automatically switches to normal operation.</p> |
|  | <p>Maintenance signal</p> <ul style="list-style-type: none"> • The green POWER LED flashes. <ul style="list-style-type: none"> → Change the Service-Unit |

For further information about fault indications during operation, see section “15. Troubleshooting” on page 52.

10. Maintenance

10.1 Warning notices

| Personnel | |
|--|---|
| Skilled technical personnel - product servicing (see section "2.3 Target group and personnel" on page 8) | |
| DANGER | Sudden escape of pressurised fluids |
|  | <p>There is a danger of death or serious personal injury resulting from contact with fast or suddenly escaping fluids or through bursting system parts.</p> <ul style="list-style-type: none"> • Before starting work, depressurise the pressurised system and secure it against unintentional pressurisation. |
| DANGER | Electric voltage |
|  | <p>Contact with electrically live components can result in death or serious injury.</p> <ul style="list-style-type: none"> • Only carry out maintenance and repair work on the product when it has been isolated from the power source and locked and tagged out. • Comply with all locally applicable legal requirements and regulations during installation. |
| WARNING | Ingress of moisture or foreign bodies |
|  | <p>Removing components or opening the product may allow water or foreign bodies to enter the opened product. This can lead to accidents, personal injury and damage to property as well as impaired operation.</p> <ul style="list-style-type: none"> • Protect the product from splashing water or moisture. • Only open the product or remove components in a dry place. • Do not insert any foreign bodies into the openings of the product. • Keep all contact surfaces and openings free of dirt and moisture. • Do not clean using pressure washers or steam cleaners. |

10.2 Maintenance schedule

| Maintenance | Interval |
|----------------------------|---|
| Replacing the Service-Unit | After 2 x 8760 operating hours or 1 million switching cycles*; at least every 2 years |
| Cleaning | Annually |
| Functional test | Monthly |
| Visual inspection | Weekly |
| Leakage test | After mounting, installation and maintenance work on the product |

* based on 7 bar(g) (101.5 psi(g)) and pH-neutral condensate

| INFORMATION | Carrying out cleaning work |
|---|--|
|  | Carry out cleaning work during wear part replacement since all parts are disassembled at this point. |

10.3 Maintenance work

For maintenance work to be carried out, the following prerequisites must be fulfilled and the preparatory tasks must have been completed.

| Prerequisites | | |
|--|---|--|
| Tools | Material | Protective equipment |
| <ul style="list-style-type: none"> Screwdriver – flat head size 2.5 mm (0.09 in) Combination wrench or adjustable wrench | <ul style="list-style-type: none"> Sealants Lubricant for greasing the O-rings Mild cleaning agent Cotton or disposable cloth | <p>Always to be worn:</p>  |

| Preparatory tasks | |
|-------------------|--|
| 1. | The product has been fully shut down (see “12. Shut-down procedure” on page 46). |

10.3.1 Changing the Service-Unit

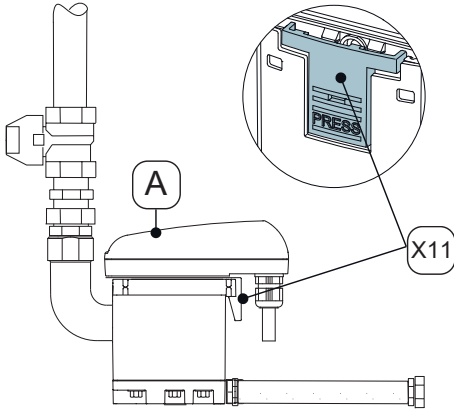
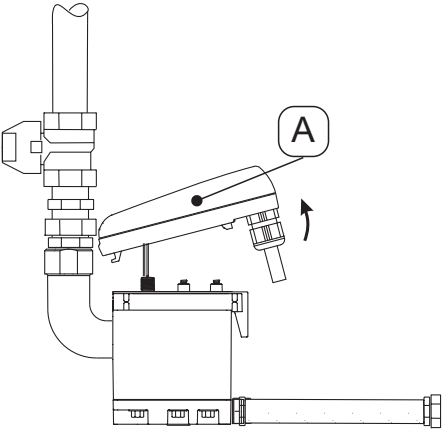
| Replacement work | |
|---|--|
| Illustration | Description / explanation |
|  | <ol style="list-style-type: none"> Release the control unit [A] by pressing the locking hook [X11]. |
|  | <ol style="list-style-type: none"> Remove the control unit [A]. |

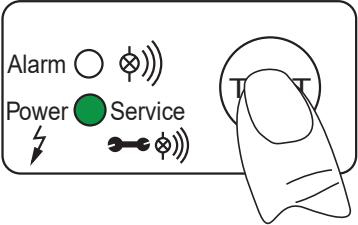
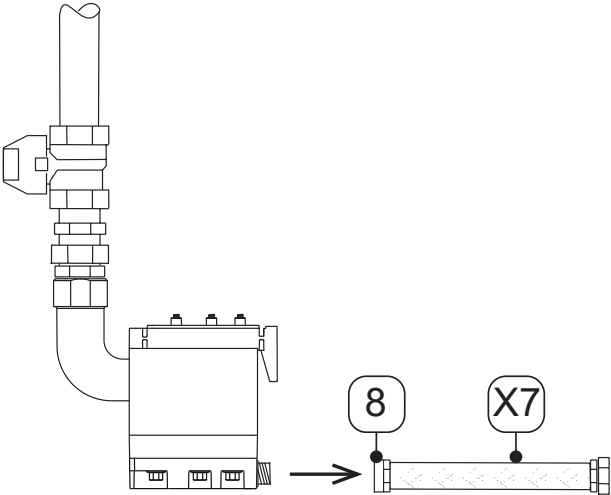
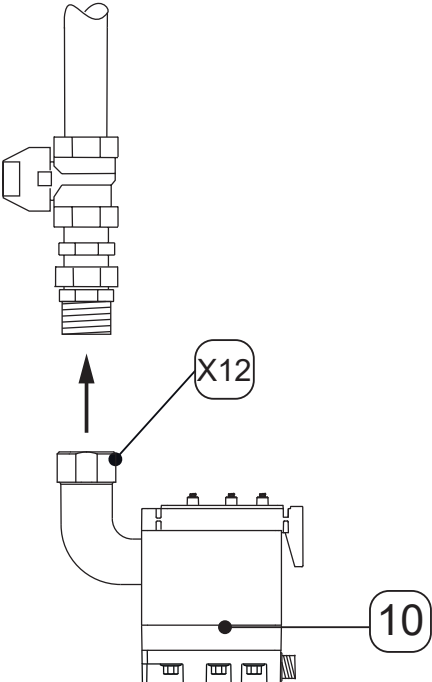
| Replacement work | |
|---|--|
| Illustration | Description / explanation |
|  | <ol style="list-style-type: none"> 3. Press the TEST button [A] on the control unit and hold it for at least 5 seconds. <ul style="list-style-type: none"> → The green POWER LED flashes 4. Once the green POWER LED is permanently lit, release the TEST button. <ul style="list-style-type: none"> → The "Service time" counter is reset 5. Carefully put the control unit [A] aside. |
|  | <ol style="list-style-type: none"> 6. Remove the hose fitting [8] with the hose [X7]. |
|  | <ol style="list-style-type: none"> 7. Remove the Service-Unit [10] from the pipe on the condensate inlet by undoing the union nut [X12]. 8. Dispose of the old Service-Unit properly (see "14. Disposal" on page 50). |

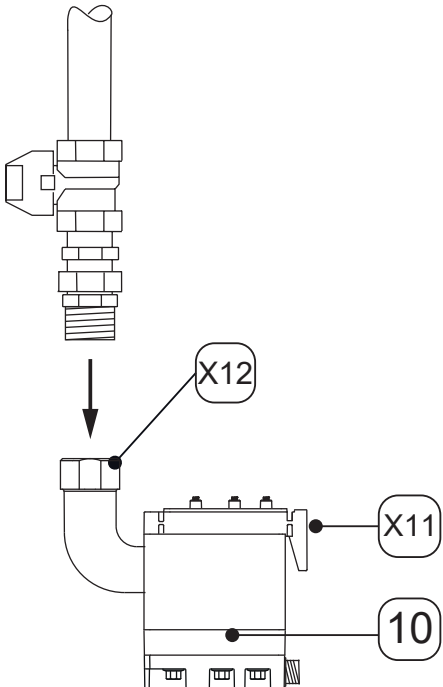
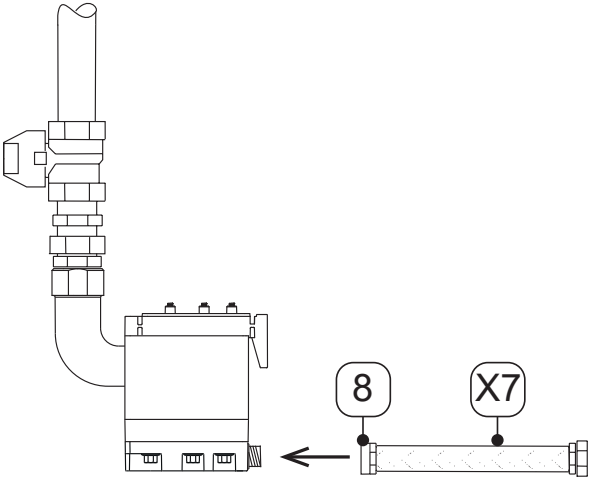
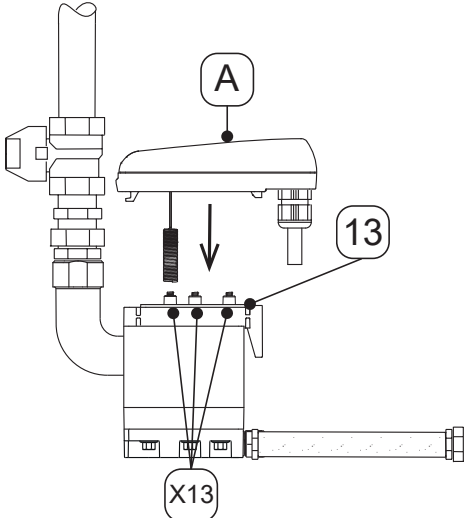
| Replacement work | |
|---|--|
| Illustration | Description / explanation |
|  | <p>9. Check to ensure the new Service-Unit [10] fits the control unit [A]:</p> <ul style="list-style-type: none"> → Model designation → The colour of the locking hook [X11] is identical to the colour of the control unit <p>10. Install pipes between the new Service-Unit [10] and the condensate inlet.</p> <p>11. Tighten the union nut [X12] firmly.</p> |
|  | <p>12. Fit the hose connection [8] with the hose [X7].</p> |
|  | <p>13. Check to confirm that the sealing mat [13] with contact springs [X13] is clean, dry and free of foreign objects.</p> <p>14. Insert the sensor of the control unit [A] into the sensor tube opening.</p> |

| Replacement work | |
|------------------|--|
| Illustration | Description / explanation |
| | <p>15. Insert the hooks on the control unit [A].</p> <p>16. Press the control unit [A] against the Service-Unit [10] and lock into place.</p> |
| | <p>17. Carry out a leakage test on all screw fittings.</p> <p>18. Carefully open the condensate feed via the condensate inlet lines [X5] (e.g., by opening the recommended shut-off valve [X6]).</p> |

10.3.2 Functional test

| Illustration | Description / explanation |
|--------------|--|
| | <p>Press the TEST button for 2 ... 5 seconds.</p> <ul style="list-style-type: none"> → The green POWER LED lights up → The valve opens and condensate is drained |

10.3.3 Visual inspection



During the visual inspection of the product, inspect all components for mechanical damage and corrosion. Replace damaged components immediately.

10.3.4 Leakage test

The leakage test is a non-destructive test method and is used to prove leak tightness in vacuum and overpressure systems. The leakage test can be carried out in different ways. The manufacturer does not recommend any specific method over another. Selection and determination of the test procedure is the responsibility of the company operating the pressurised system and must be carried out in conformity with the applicable standards and guidelines (e.g., DIN EN 1779)

10.3.5 Cleaning

10.4 Warning notices

| | |
|---|--|
| CAUTION | Personal injury through inappropriate use of cleaning media |
|  | <p>Inappropriate use of cleaning media may result in minor injuries and damage to health.</p> <ul style="list-style-type: none"> • Never clean the device with a dripping wet cloth. • Do not clean using pressure washers. • Never use abrasive or aggressive cleaning agent or solvents which could damage the outer coating (e.g. markings, type plate, corrosion protection, etc.). • Never clean the device with hard or pointed implements. • Use an anti-static, damp cloth for cleaning the outside. • Immediately replace any product markings (pictograms, markings) that have become illegible. • Use personal protective equipment. • Use cleaning media in accordance with the manufacturer's instructions. |
| NOTE | Observe local hygiene regulations |
|  | In addition to the cleaning instructions listed, any regionally applicable or company-specific hygiene regulations must be observed. |

Preparatory tasks

| | |
|----|--|
| 1. | The product has been fully shut down (see section "12. Shut-down procedure" on page 46). |
|----|--|

Cleaning work

| | |
|----|--|
| 1. | Spray mild cleaning agent onto a cotton cloth or disposable tissue until it is damp (not wet). |
| 2. | Rub the surfaces of the product with the damp cloth. |

Final steps

| | |
|----|--|
| 1. | Start the product up (see section "8. Start-up procedure" on page 35). |
|----|--|

11. Consumables, accessories and spare parts

11.1 Order information

Manufacturer customer service requires the following data for an enquiry or order:

- Serial number (see type plate)
- Material number and designation of the accessory or spare part
- Required quantity of accessories or spare parts to be delivered

The contact data for the relevant manufacturer customer services are listed in section “1.1 Contact” on page 5.

11.2 Accessories

| Description | Material no. |
|----------------------|--------------|
| 230 VAC trace heater | 4041657 |
| Drain kit | 2000045 |

11.3 Spare parts



| Description / explanation | Material no. |
|----------------------------------|--------------|
| Service-Unit BEKOMAT® 32U | 4023571 |
| Set of seals | 4024392 |

12. Shut-down procedure

12.1 Warning notices

Personnel

Skilled technical personnel - product servicing (see section "2.3 Target group and personnel" on page 8)

| | |
|---|---|
| DANGER | Sudden escape of pressurised fluids |
|  | <p>There is a danger of death or serious personal injury resulting from contact with fast or suddenly escaping fluids or through bursting system parts.</p> <ul style="list-style-type: none"> • Set up a safety area around the working area before starting work. • Before starting work, depressurise the pressurised system and secure it against unintentional pressurisation. |
| DANGER | Electric voltage |
|  | <p>There is a danger of death or serious injuries as well as malfunction and device failure following contact with components which are in contact with electric voltage.</p> <ul style="list-style-type: none"> • Set up a safety area around the working area before starting work. • Before starting work, isolate the product and accessories from the power source and secure them against being switched back on again unintentionally. |

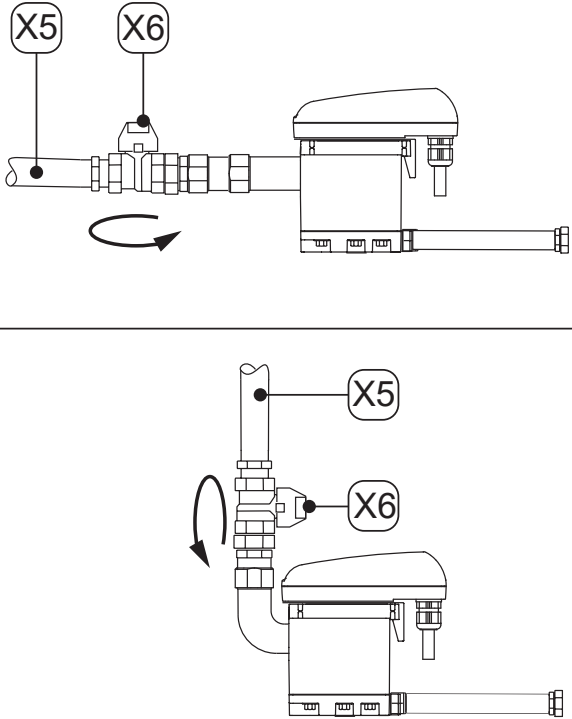
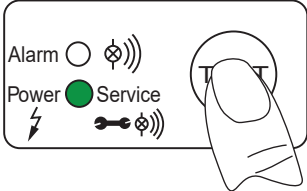

12.2 Shut-down steps

| Illustration | Description / explanation |
|---|---|
|  | <ol style="list-style-type: none"> 1. Interrupt the condensate feed at the condensate inlet line [X5] (e.g., by closing the recommended shut-off valve [X6]). |
|  | <ol style="list-style-type: none"> 2. Press the TEST button briefly multiple times. <ul style="list-style-type: none"> → The BEKOMAT® is depressurised → The condensate remaining in the BEKOMAT® is drained 3. Disconnect the BEKOMAT® from the power supply and switch off all power. |

13. Dismounting



13.1 Warning notices

| Personnel | |
|--|--|
| Skilled technical personnel - product servicing (see section “2.3 Target group and personnel” on page 8) | |

| | |
|---|---|
| DANGER | Sudden escape of pressurised fluids |
|  | <p>There is a danger of death or serious personal injury resulting from contact with fast or suddenly escaping fluids or through bursting system parts.</p> <ul style="list-style-type: none"> • Set up a safety area around the working area before starting work. • Before starting work, depressurise the pressurised system and secure it against unintentional pressurisation. |
| DANGER | Electric voltage |
|  | <p>There is a danger of death or serious injuries as well as malfunction and device failure following contact with components which are in contact with electric voltage.</p> <ul style="list-style-type: none"> • Set up a safety area around the working area before starting work. • Before starting work, isolate the product and accessories from the power source and secure them against being switched back on again unintentionally. |

13.2 Dismounting steps

For dismounting work to be carried out, the following prerequisites must be met and the preparatory tasks must have been completed.

| Prerequisites | | |
|---|---|--|
| Tools | Material | Protective equipment |
| <ul style="list-style-type: none"> • Combination wrench or adjustable wrench | <ul style="list-style-type: none"> • No material necessary | <p style="text-align: center;">Always to be worn:</p> <div style="display: flex; justify-content: center; gap: 10px;">    </div> |

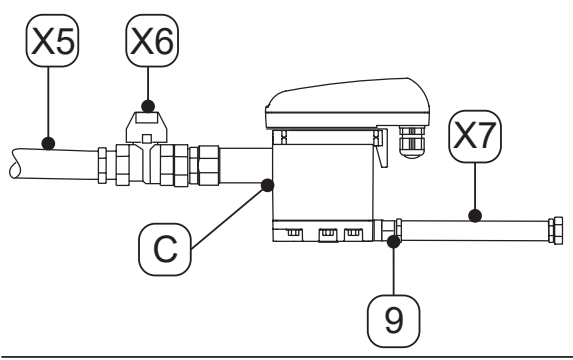
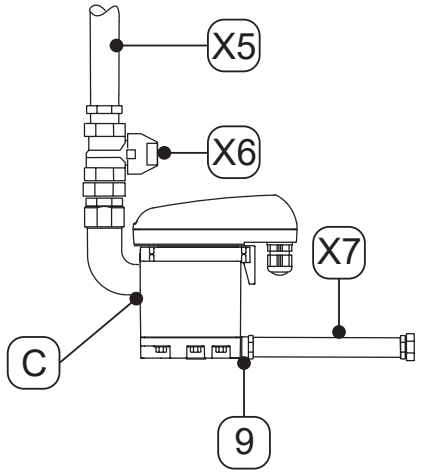

| Preparatory tasks | |
|-------------------|---|
| 1. | The product has been fully shut down (see section “12. Shut-down procedure” on page 46). |
| 2. | Depressurise the pressurised system or the respective system section and secure it against unintentional pressure build-up. |

| Dismounting steps | |
|--|--|
| Illustration | Description / explanation |
|  | 1. Remove the hose [X7] from the hose fitting [9]. |
|  | 2. Remove the condensate inlet line [X5] and recommended shut-off valve [X6] from the condensate inlet [C] and disassemble. 3. Disconnect all electrical connections. |

14. Disposal

At the end of their useful life the product and the accessories must be sent for disposal e.g. by a specialist company. Materials such as glass, plastics and some chemical compounds are mostly recoverable, reusable or recyclable.

14.1 Warning notices

| | |
|---|---|
| NOTE | Inappropriate disposal |
|  | <p>Inappropriate disposal of parts, components, operating and auxiliary materials as well as cleaning media can cause environmental damage.</p> <ul style="list-style-type: none"> • Dispose of all components, parts, operating and auxiliary materials as well as cleaning agents professionally and in accordance with all locally applicable legal requirements and regulations. • Dispose of electrical and electronic components using a specialist disposal company or return them to manufacturer. • In case of doubt, consult a local disposal company before disposal. |
| INFORMATION | Disposal of electrical and electronic equipment |
|  | <p>Electrical and electronic equipment (EEE) contains materials, components and substances which can be dangerous and harmful to human health and the environment if the waste from electrical and electronic equipment (WEEE) is not disposed of properly.</p> <p>Electrical and electronic equipment is marked with a crossed-out rubbish bin symbol. The crossed-out rubbish bin symbol indicates that electrical and electronic equipment must be collected separately and must not be disposed of together with unsorted household waste.</p> <p>For additional information regarding locally applicable legal requirements and regulations concerning recycling electrical and electronic products, contact your local disposal companies or the responsible municipal authority.</p> |

14.2 Disposal of operating and auxiliary materials

| Operating material / auxiliary material | EU waste code |
|---|---------------|
| Adsorption materials, filter materials, cleaning wipes and protective clothing - contaminated by oils or other hazardous substances | 15 02 02 |
| Adsorption materials, filter materials, cleaning wipes and protective clothing - with the exception of those classified by 15 02 02 | 15 02 03 |
| Packaging - paper and cardboard | 15 01 01 |
| Packaging - plastic material | 15 01 02 |
| Waste oil - mineral | 13 02 05 |
| Waste oil - synthetic | 13 02 06 |











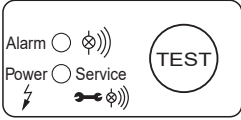



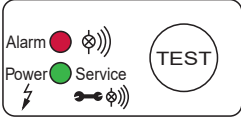



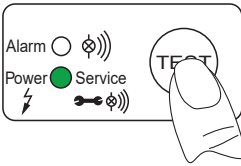

14.3 Disposal of components

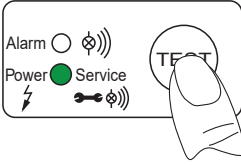
Ensure the following prerequisites are met before disposal:

| Prerequisites | |
|---------------|---|
| 1. | The product and the accessories have been shut down and dismantled. |
| 2. | The product and the accessories have been cleaned and any fluid residue has been removed. |

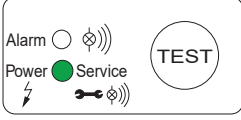
| Components | EU waste code |
|--|---------------|
| Electric and electronic devices with the exception of those covered by 20 01 21, 20 01 23 and 20 01 35 | 20 01 36 |
| Plastic material | 20 01 39 |
| Metals | 20 01 40 |

15. Troubleshooting

| Error or fault pattern | Possible causes | Troubleshooting |
|--|--|---|
|  <p>Alarm <input type="checkbox"/>  Power <input type="checkbox"/>  Service <input type="checkbox"/> </p> <p>TEST</p> | <ul style="list-style-type: none"> All LEDs are off | <ul style="list-style-type: none"> Read off the operating voltage on the type plate and check it Check whether voltage is present at the terminals of the sensor board (L, N) Check the connection terminals on the sensor board. |
|  <p>Alarm <input checked="" type="checkbox"/>  Power <input checked="" type="checkbox"/>  Service <input checked="" type="checkbox"/> </p> <p>TEST</p> | <ul style="list-style-type: none"> All LEDs are on continuously | <ul style="list-style-type: none"> Disconnect the product from the power supply and reconnect after > 5 seconds Inspect the sensor board for potential damage |
|  <p>Alarm <input checked="" type="checkbox"/>  Power <input checked="" type="checkbox"/>  Service <input checked="" type="checkbox"/> </p> <p>TEST</p> | <ul style="list-style-type: none"> No condensate is drained after pressing the TEST button | <ul style="list-style-type: none"> Check the inlet and the drain line Replace the Service-Unit Check the valve function by pressing the TEST button → Valve switching can be heard clearly (clicking sound) Check the connection terminals on the sensor board. |
|  <p>Alarm <input checked="" type="checkbox"/>  Power <input checked="" type="checkbox"/>  Service <input checked="" type="checkbox"/> </p> <p>TEST</p> | <ul style="list-style-type: none"> Condensate is only drained when the TEST button is pressed | <ul style="list-style-type: none"> Install the inlet line with a slope > 3 % Install a venting line Check whether the necessary minimum pressure has been reached (see "4. Technical data" on page 19) Replace the Service-Unit |
|  <p>Alarm <input checked="" type="checkbox"/>  Power <input checked="" type="checkbox"/>  Service <input checked="" type="checkbox"/> </p> <p>TEST</p> | <ul style="list-style-type: none"> The BEKOMAT® discharges continuously | <ul style="list-style-type: none"> Replace the Service-Unit |

16. Appendices

16.1 Certificates

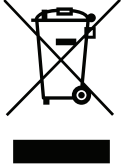
| Symbol | Description / explanation |
|---|---|
|  | <p>CE marking</p> <p>The CE marking indicates that a product fulfils all the EU regulations applicable to the product and that all basic safety and health requirements were met during its production. The product may be sold on the European market.</p> |
|  | <p>WEEE marking</p> <p>The crossed out rubbish bin marks an electrical or electronic product that must not be disposed of with domestic waste at the end of its service life. Free collecting points for used electrical equipment as well as further acceptance points for reuse of the products are available for them to be returned. Addresses can be obtained from the local authorities.</p> |

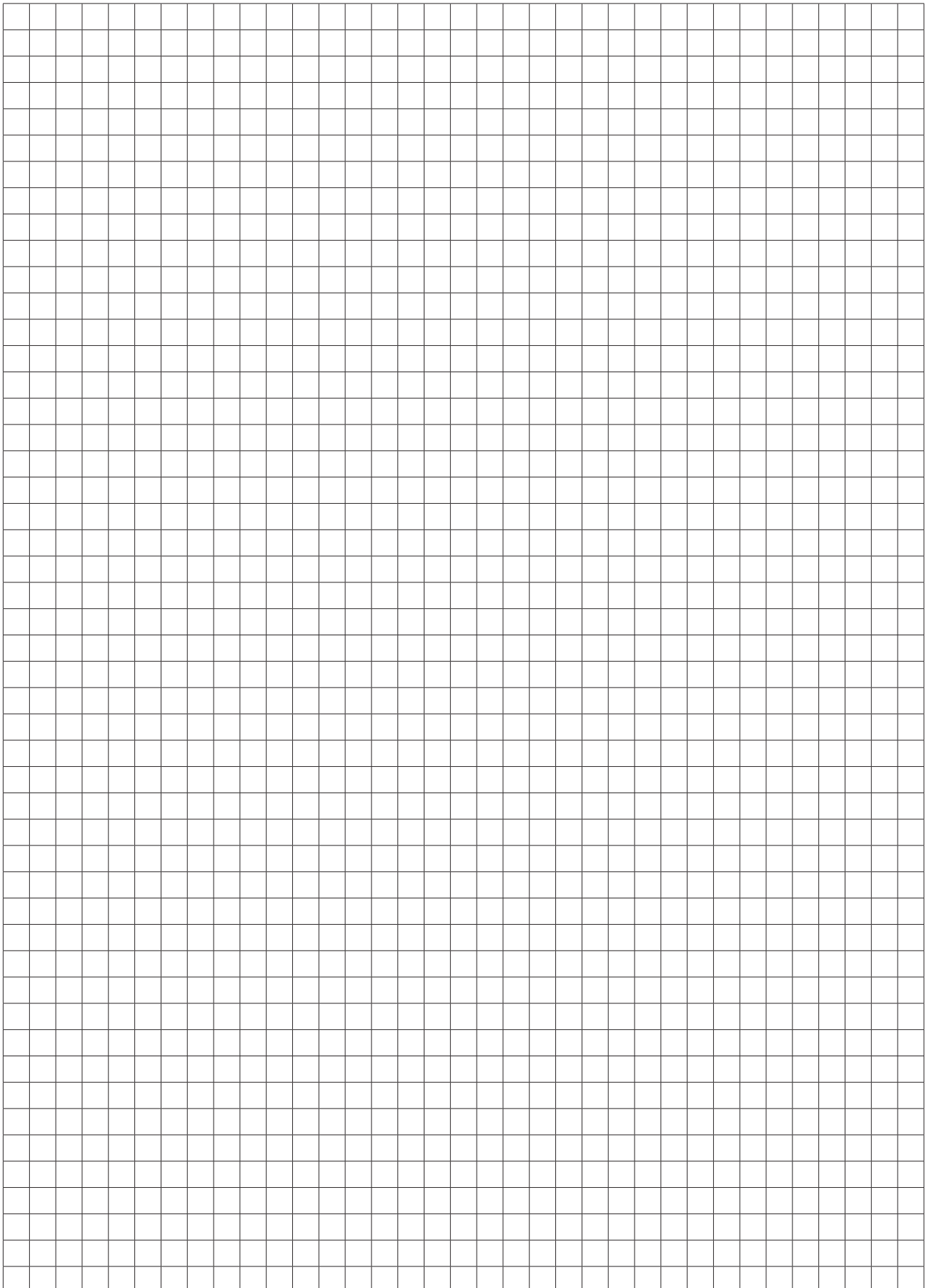

BEKO TECHNOLOGIES GmbH

Im Taubental 7
 D - 41468 Neuss
 Tel. +49 2131 988 0
 Fax +49 2131 988 900
 info@beko-technologies.com
 service-eu@beko-technologies.com

DE**BEKO TECHNOLOGIES LTD.**

Unit 11-12 Moons Park
 Burnt Meadow Road
 North Moons Moat
 Redditch, Worcs, B98 9PA
 Tel. +44 1527 575 778
 info@beko-technologies.co.uk

GB**BEKO TECHNOLOGIES S.à.r.l.**

Zone Industrielle
 1 Rue des Frères Rémy
 F - 57200 Sarreguemines
 Tél. +33 387 283 800
 info@beko-technologies.fr
 service@beko-technologies.fr

FR**BEKO TECHNOLOGIES B.V.**

Veenen 12
 NL - 4703 RB Roosendaal
 Tel. +31 165 320 300
 benelux@beko-technologies.com
 service-bnl@beko-technologies.com

NL**BEKO TECHNOLOGIES
(Shanghai) Co. Ltd.**

Rm.715 Building C, VANTONE Center
 No.333 Suhong Rd.Minhang District
 201106 Shanghai
 Tel. +86 (21) 50815885
 info.cn@beko-technologies.cn
 service1@beko.cn

CN**BEKO TECHNOLOGIES s.r.o.**

Na Pankraci 58
 CZ - 140 00 Praha 4
 Tel. +420 24 14 14 717 /
 +420 24 14 09 333
 info@beko-technologies.cz

CZ**BEKO Tecnológica España S.L.**

Torruella i Urpina 37-42, nave 6
 E - 08758 Cervelló
 Tel. +34 93 632 76 68
 Mobil +34 610 780 639
 info.es@beko-technologies.es

ES**BEKO TECHNOLOGIES LIMITED**

Room 2608B, Skyline Tower,
 No. 39 Wang Kwong Road
 Kwoloon Bay Kwoloon, Hong Kong
 Tel. +852 2321 0192
 Raymond.Low@beko-technologies.com

HK**BEKO TECHNOLOGIES INDIA Pvt. Ltd.**

Plot No.43/1 CIEEP Gandhi Nagar
 Balanagar Hyderabad
 IN - 500 037
 Tel. +91 40 23080275 /
 +91 40 23081107
 Madhusudan.Masur@bekoindia.com
 service@bekoindia.com

IN**BEKO TECHNOLOGIES S.r.l**

Via Peano 86/88
 I - 10040 Leinì (TO)
 Tel. +39 011 4500 576
 Fax +39 0114 500 578
 info.it@beko-technologies.com
 service.it@beko-technologies.com

IT**BEKO TECHNOLOGIES K.K**

KEIHIN THINK Building 8 Floor
 1-1 Minamiwatarida-machi
 Kawasaki-ku, Kawasaki-shi
 JP - 210-0855
 Tel. +81 44 328 76 01
 info@beko-technologies.jp

JP**BEKO TECHNOLOGIES Sp. z o.o.**

ul. Pańska 73
 PL - 00-834 Warszawa
 Tel. +48 22 314 75 40
 info.pl@beko-technologies.pl

PL**BEKO TECHNOLOGIES S. de R.L. de C.**

BEKO Technologies, S de R.L. de C.V.
 Blvd. Vito Alessio Robles 4602 Bodega 10
 Zona Industrial
 Saltillo, Coahuila, 25107
 Mexico
 Tel. +52(844) 218-1979
 informacion@beko-technologies.com

MX**BEKO TECHNOLOGIES, CORP.**

900 Great Southwest Pkwy SW
 Atlanta, GA 30336
 USA
 Tel. +1 404 924-6900
 beko@bekousa.com

US